

TECHNIKA KTÓRA PORUSZA



MACO EMOTION

KLAMKI OKIENNE



Katalog



No

Numer artykułu



Długość sztyftu



Wysokość klamki



Szerokość rozetki



Szerokość szyldu drzwiowego



Rozstaw (E)



Szerokość profilu



Trzpień klamki



Powłoka



Grubość podkładki

B

Szerokość całkowita

L

Długość elementu



Ilość w opakowaniu

PZ Wkładka (PZ)

RZ Wkładka RZ

E = Rozstaw (E)









SKB Klamka do okuć przesuwno uchylnych

HS Klamka do okuć podnosząco przesuwnych

RC Klasa odporności

WK Klasa odporności



1	Informacje techniczne	<i>i</i>	5
2	TENTAZIONE		11
3	RHAPSODY		13
4	HARMONY		23
5	SYMPHONY		33
6	UNITY		41
7	TRESOR		45
8	Klamka z kutego żelaza		49
9	Pochwyty balkonowe		51
10	Dodatki EMOTION	+	53
11	Index		

MACO
EMOTION





1 **Informacje techniczne**

1.1	Informacje korzystania z katalogu _____	6
1.2	Informacje odpowiedzialności za produkt _____	7
1.3	Wskazówki dotyczące prawidłowego przechowywania zawiasów _____	8
1.4	Certyfikaty i gwarancje _____	8
1.5	Ogólne warunki sprzedaży(AGB) _____	8
1.6	Informacje techniczne dotyczące montażu _____	9



1 Informacje techniczne

1.1 Informacje korzystania z katalogu

Brak dodatkowych wytycznych oznacza, iż wszystkie wymiary są podane w milimetrach, a ilości w sztukach na opakowanie.

Wszystkie rysunki są tylko symboliczne.

Treść instrukcji może zostać zmieniona, dlatego konieczne jest regularne monitorowanie czy jest dostępna nowsza wersja instrukcji.

Wszelkie zmiany zastrzeżone.

Aktualne wersje dostępne są na stronie internetowej (www.maco.eu).

Jeśli posiadają Państwo uwagi lub sugestie dotyczące poprawy naszej instrukcji, prosimy o przesyłanie ich na adres e-mail: feedback@maco.eu.

1.2 Informacje odpowiedzialności za produkt

Zgodnie z zawartymi w Ustawie o ogólnym bezpieczeństwie produktów zobowiązaniami dot. odpowiedzialności producenta za swoje produkty (pkt.1 Ustawy o ogólnym bezpieczeństwie produktów) należy stosować się do następujących zaleceń odnośnie klamek okiennych do skrzydeł okiennych i drzwi balkonowych. Nieprzestrzeganie zaleceń zwalnia producenta z odpowiedzialności.

Informacje o produkcie i zastosowanie zgodne z przeznaczeniem

Klamki służą do tego, aby za ich pomocą wprowadzić w ruch mechanizm ryglujący i umieścić okno lub skrzydło balkonowe w pozycji otwartej, uchylonej lub zamkniętej. W szczególnych przypadkach producent musi uzyskać pewność że wybrany produkt jest odpowiedni do montażu i zagwarantowana jest jego funkcjonalność. Inne zastosowanie jest niezgodne z przeznaczeniem.

Rodzaje klamek Maco:

Klamki okienne

Klamki okienne blokowane

Klamki z rozetami

Klamki drzwiowe

Klamki krzyżowe, klamki wtykowe

Klamki do systemów przesuwno - uchylnych SKB

Klamki do systemów podnosząco - przesuwnych HS

Pochwyty balkonowe

Montaż

Montaż klamek MACO jest zalecany tylko przez wykwalifikowany personel. Wiercone otwory pod czopy klamki powinny mieć odpowiednią wielkość i lokalizację. Trzpień klamki musi zagwarantować odpowiednie zespolenie z otworem orzecha zasuwownicy. Klamki muszą pracować lekko i bez oporów. Należy stosować śruby mocujące o odpowiedniej długości.

Użycie narzędzi jak młotek w czasie montażu jest niedopuszczalne.

Zastosowanie niezgodne z przeznaczeniem

Niewłaściwe zastosowanie a więc zastosowanie niezgodne z przeznaczeniem :

Stosowanie siły wykraczającej poza normalne siły operacyjne.

Stosowanie dodatkowych obciążeń lub używanie nieodpowiednich narzędzi.

Stosowanie elementów nieoryginalnych i niedopuszczonych przez producenta.

Uszkodzenia mechaniczne.

Uszkodzenia substancjami żrącymi lub ściernymi.

Zanieczyszczenie zaprawami budowlanymi.

Konserwacja

Długie i bezproblemowe funkcjonowanie klamek MACO gwarantuje:

Niezbędne informacje i instrukcje przekazywać właściwym osobom.

Przestrzegać obowiązujące normy.

Stosowanie zgodne z przeznaczeniem.

Przestrzeganie instrukcji producenta.

Przestrzeganie instrukcji konserwacji i pielęgnacji.

Usuwanie usterek przez wykwalifikowany personel.

Sprawność produktu

Jeśli działanie produktu nie jest szczegółowo określone w katalogach lub prospektach, wymagania dotyczące produktu muszą być uzgodnione z producentem. Uzgodnienia mogą dotyczyć wyłącznie stosowania z produktami MACO. Wytrzymałość klamek jest zależna od częstotliwości pracy, wpływów otoczenia, konserwacji i pielęgnacji.

Pielęgnacja

Powierzchnie klamek są na bieżąco kontrolowane i uszlachetniane według najnowszych metod. W codziennym użytkowaniu powłoka klamek może zostać uszkodzona. Niewłaściwe użytkowanie i pielęgnacja może doprowadzić do korozji elementów klamki. Klamki należy montować dopiero po zakończeniu wszelkich prac budowlanych i malarskich. Do czyszczenia używać ciepłej wody i miękkich szmatek, do ciężkich zabrudzeń stosować wyłącznie środki czyszczące z neutralnym pH. Nie używać substancji ściernych i żrących.



1.3 Wskazówki dotyczące prawidłowego przechowywania zawiasów

Niewłaściwe przechowywanie okuć może wpływać na jakość powierzchni. Aby temu zapobiec, należy zwrócić uwagę na następujące punkty:

- Należy upewnić się, że powietrze w pomieszczeniu jest trwale suche.
- Należy zapobiegać dużym wahanom temperatury powodującym występowanie kondensacji. Wystąpienie kondensacji na okuciach oznacza że powierzchnie ocynkowane są

atakowane.

- Należy wyeliminować agresywne opary środków czyszczących oraz środków montażowych jak silikony i podobne. Opary takich substancji powodują szybką korozję okuć..
- Stłone lub zanieczyszczone przemysłowo powietrze jest niekorzystne dla okuć i prowadzi również do korozji powierzchni ocynkowanej.

1.4 Certyfikaty i gwarancje

MACO potwierdza jakość swoich produktów poprzez szereg testów wewnętrznych oraz testy wykonywane przez zewnętrzne niezależne i renomowane instytuty. Wszystkie ak-

tualne certyfikaty oraz gwarancje dostępne są na stronie www.maco.eu oraz extranet.maco.eu

1.5 Ogólne warunki sprzedaży(AGB)

Ogólne warunki sprzedaży dostępne są na stronie internetowej (www.maco.eu).

1.6 Informacje techniczne dotyczące montażu

1.6.1 Rozwierno - uchylne, uchylno - rozwierno, rozwierno



Wyliczenie długości sztyftu

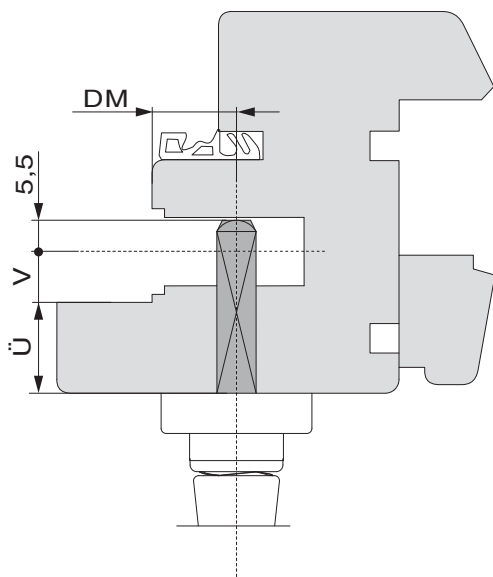

Ü = Przyłga

V = Oś

DM = odsadzenie osi klamki

Wyliczenie długości śrub

Wkręt

Śruba

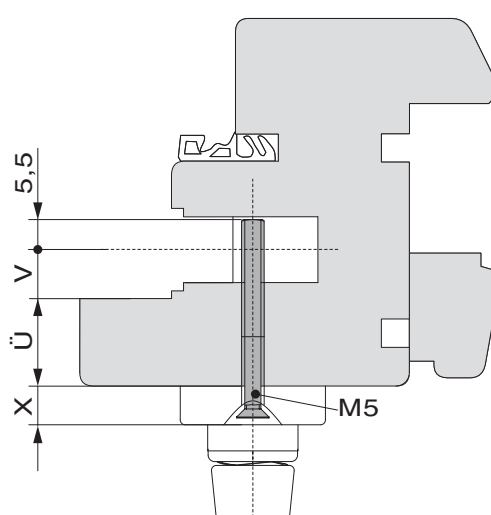
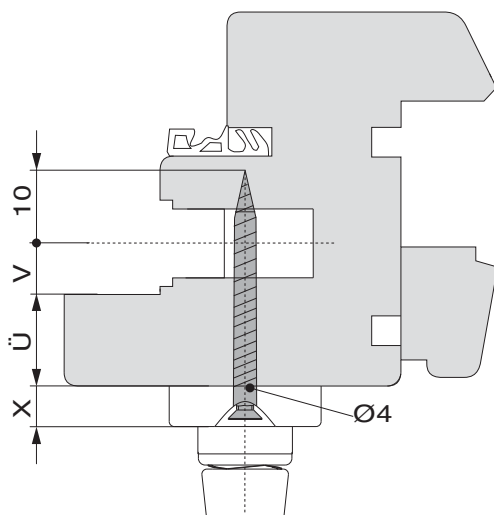

X = 8 mm: Harmony, Symphony

X = 9,5 mm: Rhapsody

Ü = Przyłga

V = Oś

Rysunek wiercenia

Rozeta z krzywką $\varnothing 10$

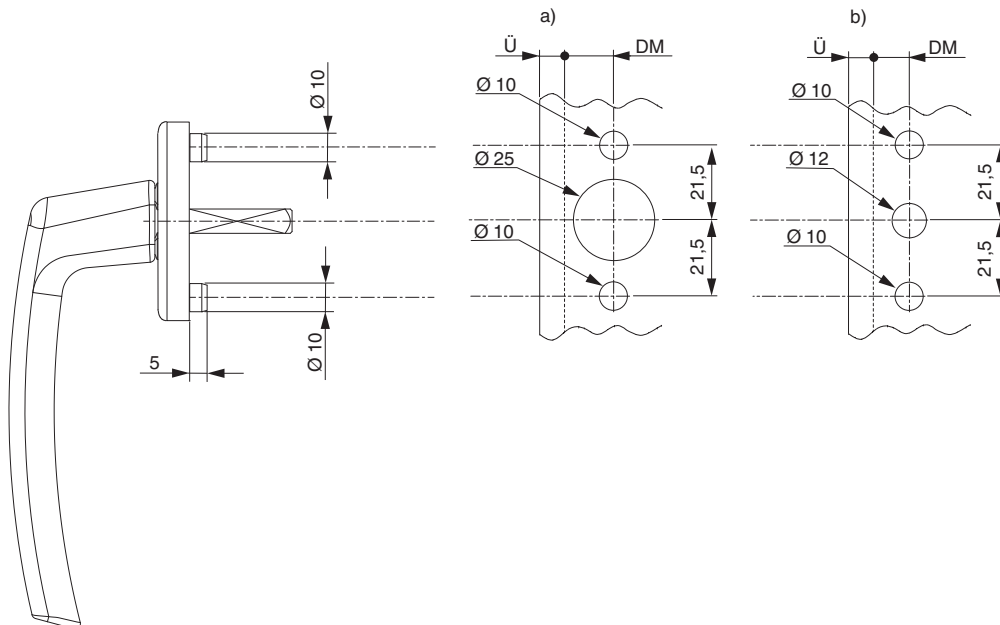

Krzywki zapewniają lepszą stabilizację klamki

a) Profile drewniane

b) Profile PVC

Rozeta z krzywką $\varnothing 12$

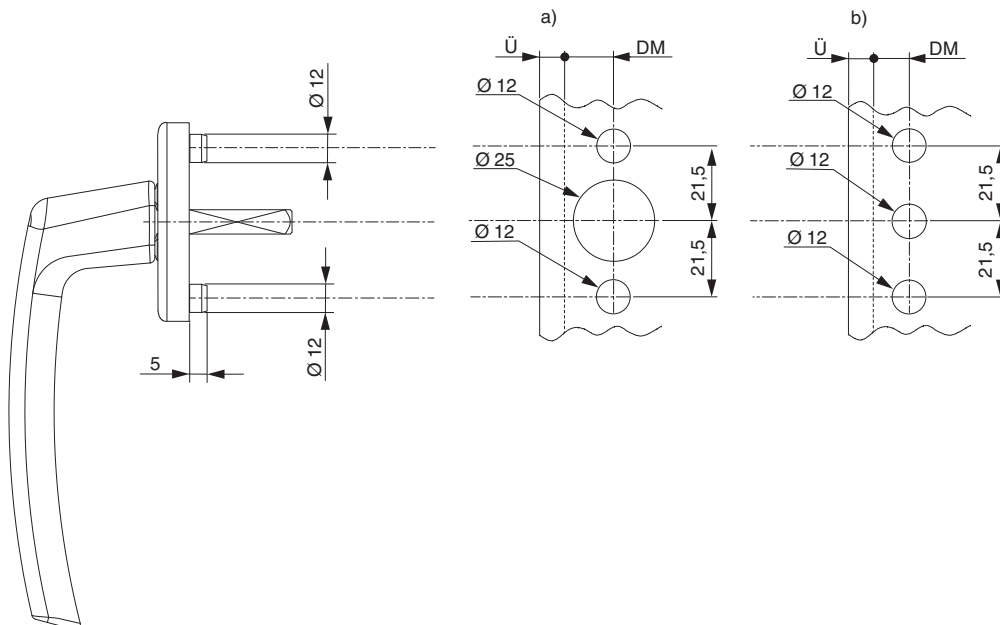

Krzywki zapewniają lepszą stabilizację klamki

a) Profile drewniane

b) Profile PVC





2 TENTAZIONE

2.1	Klamka chowana _____	12
2.2	Szablon _____	12

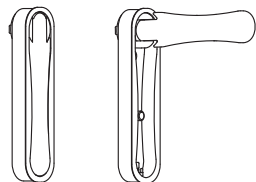
2 TENTAZIONE



461769

H	2.1 Klamka chowana							No
		4,5	30	37	7			
	Gold-Look	4,5	30	37	7	gold-powlekany	1	461769 ¹
	RAL 9016	4,5	30	37	7	mal. proszkowo	1	461772 ¹
	Stal nierdzewna	4,5	30	37	7	niklowany	1	461773 ¹
	chrom polerowany	4,5	30	37	7	chromowany	1	461771 ¹
	chrom szczotkowany	4,5	30	37	7	chromowany	1	461770 ¹

¹ Stosowanie z PVC lub aluminium na zapytanie

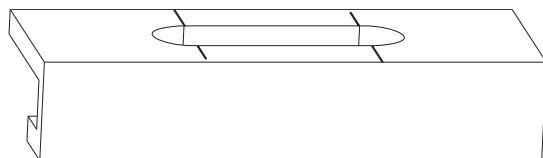

461889

2.2 Szablon					No
Szablon frezowania do klamki Tentazione drewno	1	461889			







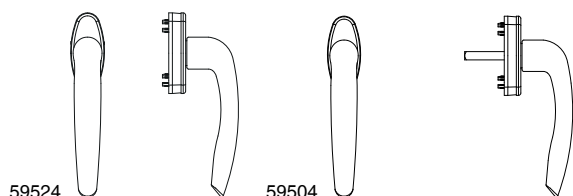

3 Rhapsody

3.1	Klamka _____	14
3.2	Klamka 45° _____	15
3.3	Klamka z kluczykiem, 45° _____	16
3.4	Klamka z przyciskiem, 45° _____	17
3.5	Klamki do okien UR _____	18
3.6	Komplet klamek z rozetami _____	19
3.7	Klamka krzyżowa, czopy 10/12 _____	21
3.8	Rozeta z klapką, czopy 10/12 _____	21
3.9	Klamka wtykowa _____	21





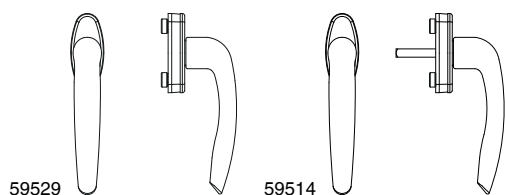

3 RHAPSODY

3.1 Klamka



3.1.1 Czopy 10								No
RAL 9016		57	30	0	7	powlekany PVC	20	59524
				32	7	powlekany PVC	20	59504
				35	7	powlekany PVC	20	59509
jasnobrązowy		57	30	0	7	anodowany	20	59521
				32	7	anodowany	20	59501
				35	7	anodowany	20	59506
srebrny		57	30	0	7	anodowany	20	59522
				32	7	anodowany	20	59502
				35	7	anodowany	20	59507
szampański		57	30	0	7	anodowany	20	59523
				32	7	anodowany	20	59503
				35	7	anodowany	20	59508
tytanowy		57	30	0	7	anodowany	20	59520
				32	7	anodowany	20	59500
				35	7	anodowany	20	59505



3.1.2 Czopy 12								No
RAL 9016		57	30	0	7	powlekany PVC	20	59529
				32	7	powlekany PVC	20	59514
				35	7	powlekany PVC	20	59519
jasnobrązowy		57	30	0	7	anodowany	20	59526
				32	7	anodowany	20	59511
				35	7	anodowany	20	59516
srebrny		57	30	0	7	anodowany	20	59527
				32	7	anodowany	20	59512
				35	7	anodowany	20	59517
szampański		57	30	32	7	anodowany	20	59513
				35	7	anodowany	20	59518
				0	7	anodowany	20	59525
tytanowy		57	30	0	7	anodowany	20	59525
				32	7	anodowany	20	59510
				35	7	anodowany	20	59515

3.2 Klamka 45°

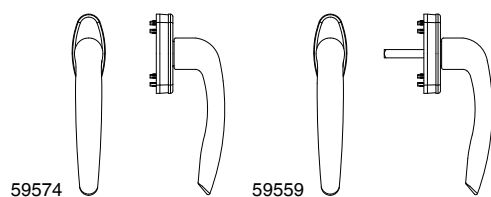



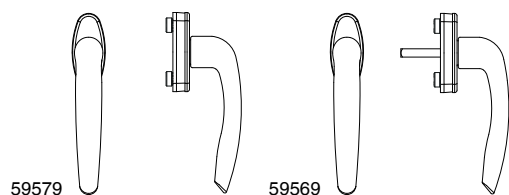



3.2.1 Czopy 10	59574		59559		↓	↓	No
	57	30	0	7			
RAL 9016	57	30	0	7	powlekany PVC	20	59574
			35	7	powlekany PVC	20	59559
			43	7	powlekany PVC	20	229042
jasnobrązowy	57	30	0	7	anodowany	20	59571
			35	7	anodowany	20	59556
			43	7	anodowany	20	229038
srebrny	57	30	0	7	anodowany	20	59572
			35	7	anodowany	20	59557
			43	7	anodowany	20	229040
szampański	57	30	0	7	anodowany	20	59573
			35	7	anodowany	20	59558
			43	7	anodowany	20	229039
tytanowy	57	30	0	7	anodowany	20	59570
			35	7	anodowany	20	59555
			43	7	anodowany	20	229041

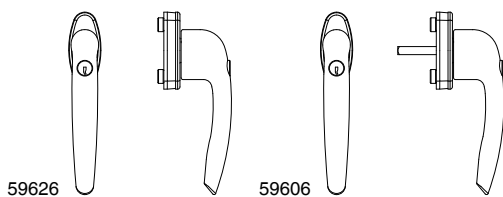

3.2.2 Czopy 12	59579		59569		↓	↓	No
	57	30	0	7			
RAL 9016	57	30	0	7	powlekany PVC	20	59579
			35	7	powlekany PVC	20	59569
jasnobrązowy	57	30	0	7	anodowany	20	59576
srebrny	57	30	0	7	anodowany	20	59577
			35	7	anodowany	20	59567
			40	7	anodowany	50	229043
szampański	57	30	0	7	anodowany	20	59578
tytanowy	57	30	0	7	anodowany	20	59575
			35	7	anodowany	20	59565







3.3 Klamka z kluczykiem, 45°

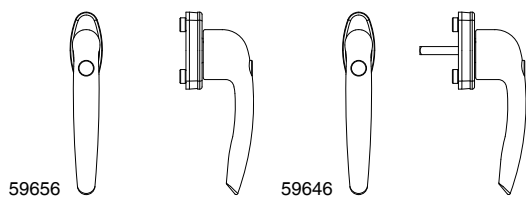

3.3.1 Czopy 10/12							No
RAL 9016	57	30	0	7	mal. proszkowo	10	59626
			32	7	mal. proszkowo	10	59606
			35	7	mal. proszkowo	10	59616
jasnobrązowy	57	30	0	7	anodowany	10	59623
srebrny	57	30	0	7	anodowany	10	59624
			32	7	anodowany	10	59604
			35	7	anodowany	10	59614
szampański	57	30	0	7	anodowany	10	59625
tytanowy	57	30	0	7	anodowany	10	59622
			32	7	anodowany	10	59602
			35	7	anodowany	10	59612

3.4 Klamka z przyciskiem, 45°







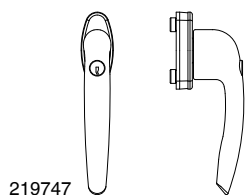

3.4.1 Czopy 10/12	 		 				No
	57	30	0	7			
RAL 9016	57	30	0	7	mal. proszkowo	10	59656
			35	7	mal. proszkowo	10	59646
jasnobrązowy	57	30	0	7	anodowany	10	59653
srebrny			32	7	anodowany	10	59634
			35	7	anodowany	10	59644
szampański	57	30	0	7	anodowany	10	59655
tytanowy			0	7	anodowany	10	59652
			32	7	anodowany	10	59632
			35	7	anodowany	10	59642



3.5 Klamki do okien UR



219747

3.5.1 Czopy 10/12								No
RAL 8019	57	28	0	7	mal. proszkowo	10	219748	
			40	7	mal. proszkowo	10	224082	
RAL 9016	57	28	0	7	mal. proszkowo	10	219747	
			32	7	mal. proszkowo	10	224462	
			35	7	mal. proszkowo	10	219740	
			40	7	mal. proszkowo	10	224081	
jasnobrązowy	57	28	32	7	anodowany	10	224464	
			40	7	anodowany	10	224079	
srebrny	57	28	0	7	anodowany	10	219742	
			35	7	anodowany	10	219222	
			40	7	anodowany	10	224075	
szampański	57	28	0	7	anodowany	10	219743	
tytanowy	57	28	0	7	anodowany	10	219746	
			35	7	anodowany	10	219739	
			40	7	anodowany	10	224080	
			43	7	anodowany	10	224453	





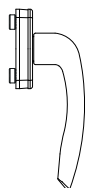

3.6 Komplet klamek z rozetami

3.6.1 Pod wkładkę PZ





14607

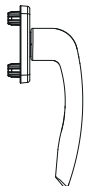

3.6.1.1 Klamka wewnętrzna wysoka, czopy 12								N^o
RAL 9016	PZ	57	30	7	powlekany PVC	10		14607
jasnobrązowy	PZ	57	30	7	anodowany	10		14604
srebrny	PZ	57	30	7	anodowany	10		14605
szampański	PZ	57	30	7	anodowany	10		14606
tytanowy	PZ	57	30	7	anodowany	10		14603



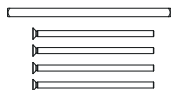

105650

3.6.1.2 Klamka zewnętrzna wysoka, czopy 12				N^o
RAL 9016	PZ	mal. proszkowo	10	105650
jasnobrązowy	PZ	anodowany	10	105646
srebrny	PZ	anodowany	10	105648
szampański	PZ	anodowany	10	105647
tytanowy	PZ	anodowany	10	105649





105749

3.6.1.3 Sztyft i wkręty do kompletu klamki z rozetą wysokiej				N^o
Sztyft i śruby do kompletów klamek wysokich i niskich		67,5-76	10	105746
		76-86	10	105747
		86-96	10	105748
		96-106	10	105749



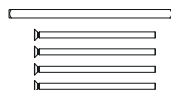

105655

3.6.1.4 Klamka zewnętrzna niska, czopy 12					№
RAL 9016	PZ	mał. proszkowo	10	105655	
jasnobrązowy	PZ	anodowany	10	105651	
srebrny	PZ	anodowany	10	105653	
szampański	PZ	anodowany	10	105652	
tytanowy	PZ	anodowany	10	105654	





105749

3.6.1.5 Szyft i wkręty do kompletu klamki z rozetą niskiej					№
Szyft i śruby do kompletów klamek wysokich i niskich			67,5-76	10	105746
			76-86	10	105747
			86-96	10	105748
			96-106	10	105749



105660

3.6.1.6 Klamka zewnętrzna płaska, czopy 12					№
RAL 9016	PZ	mał. proszkowo	10	105660	
jasnobrązowy	PZ	anodowany	10	105656	
srebrny	PZ	anodowany	10	105658	
szampański	PZ	anodowany	10	105657	
tytanowy	PZ	anodowany	10	105659	

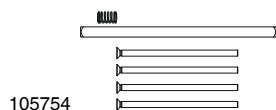

105754

3.6.1.7 Szyft i wkręty do kompletu klamki z rozetą płaskiej



№

Szyft, śruby i sprężyna do kompletów klamek płaskich

64-72	10	105750
72-82	10	105751
82-92	10	105752
92-102	10	105753
102-112	10	105754

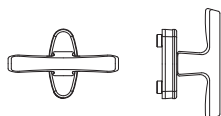

59774

3.7 Klamka krzyżowa, czopy 10/12



№

RAL 9016	30	7	mal. proszkowo	20	59774
jasnobrązowy	30	7	anodowany	20	59772
srebrny	30	7	anodowany	20	59770
szampański	30	7	anodowany	20	59771
tytanowy	30	7	anodowany	20	59773

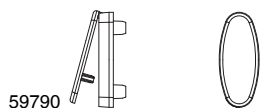

59790

3.8 Rozeta z klapką, czopy 10/12



№

RAL 9016	30		PVC	20	59790
jasnobrązowy	30		lakierowane	20	59794
szampański	30		lakierowane	20	59792
tytanowy	30		lakierowane	20	59793

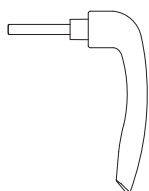

59780

3.9 Klamka wtykowa



№

srebrny	43	7	anodowany	20	59780
---------	----	---	-----------	----	--------------

MACO
EMOTION



RHAPSODY







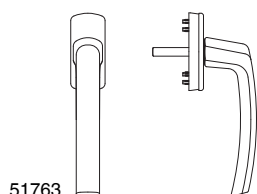

4 HARMONY

4.1	Klamka _____	24
4.2	Klamka 45° _____	26
4.3	Klamka z kluczykiem, 45° _____	26
4.4	Klamka z przyciskiem, 45° _____	27
4.5	Klamki do okien UR _____	28
4.6	Komplet klamek z rozetami _____	29
4.7	Klamka krzyżowa, czopy 10/12 _____	31
4.8	Rozeta z klapką, czopy 10/12 _____	31
4.9	Klamka wtykowa _____	31
4.10	Podkładka do rozety Harmony _____	32





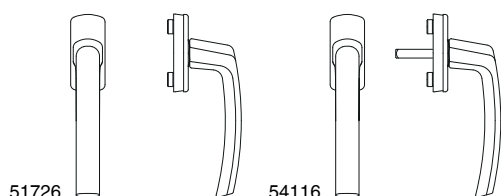

4 HARMONY

4.1 Klamka









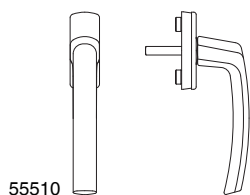

4.1.1 Czopy 10							No
RAL 8019	55	28	32	7	powlekany PVC	20	53840
			35	7	powlekany PVC	20	51856
RAL 9016	55	28	32	7	powlekany PVC	20	51763
			35	7	powlekany PVC	20	51750
jasnobrązowy	55	28	32	7	anodowany	20	53839
			35	7	anodowany	20	28856
srebrny	55	28	32	7	anodowany	20	53972
			35	7	anodowany	20	52116
srebrny (biała rozeta)	55	28	32	7	anodowany	20	54114
			35	7	anodowany	20	54124
szampański	55	28	32	7	anodowany	20	28898
			35	7	anodowany	20	28854
tytanowy	55	28	32	7	anodowany	20	28901
			35	7	anodowany	20	28861



4.1.2 Czopy 10/12							No
RAL 8019	55	28	0	7	powlekany PVC	20	54133
			32	7	powlekany PVC	20	58976
			35	7	powlekany PVC	20	51974
RAL 9016	55	28	0	7	powlekany PVC	20	51726
			32	7	powlekany PVC	20	54116
			35	7	powlekany PVC	20	51987
jasnobrązowy	55	28	0	7	anodowany	20	28738
			32	7	anodowany	20	54117
			35	7	anodowany	20	28857
srebrny	55	28	0	7	anodowany	20	55821
			32	7	anodowany	20	53979
			35	7	anodowany	20	55508
srebrny (biała rozeta)	55	28	0	7	anodowany	20	54132
			32	7	anodowany	20	54119
			35	7	anodowany	20	54129
szampański	55	28	0	7	anodowany	20	28719
			32	7	anodowany	20	54115
			35	7	anodowany	20	28855
tytanowy	55	28	0	7	anodowany	20	20695
			32	7	anodowany	20	28902







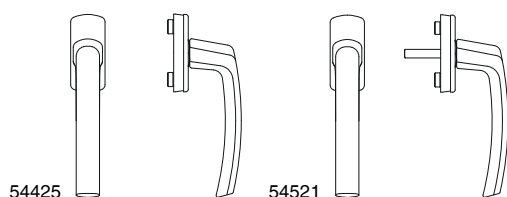

4.1.3 Czopy 10/12 z wąską rozetą										№
RAL 9016	55	24	32	7	powlekany PVC	20				55510
szampański	55	24	32	7	powlekany PVC	20				55516
tytanowy	55	24	32	7	anodowany	20				55512
			35	7	anodowany	20				55518
tytanowy	55	24	32	7	anodowany	20				55511
			35	7	anodowany	20				55517









4.2 Klamka 45°

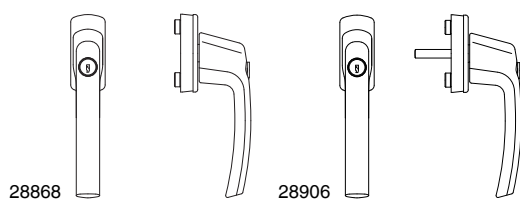

4.2.1 Czopy 10/12								No
RAL 8019		55	28	0	7	powlekany PVC	20	220598
				32	7	powlekany PVC	20	220596
				35	7	powlekany PVC	20	220597
RAL 9016		55	28	0	7	powlekany PVC	20	54425
				32	7	powlekany PVC	20	54521
				35	7	powlekany PVC	20	51650
jasnobrązowy		55	28	0	7	anodowany	20	23213
				32	7	anodowany	20	21214
				35	7	anodowany	20	51822
srebrny		55	28	0	7	anodowany	20	205152
				32	7	anodowany	20	55713
				35	7	anodowany	20	220629
srebrny (biała rozeta)		55	28	0	7	anodowany	20	220602
szampański		55	28	0	7	anodowany	20	23223
				32	7	anodowany	20	23273
				35	7	anodowany	20	54171
tytanowy		55	28	0	7	anodowany	20	23177
				32	7	anodowany	20	20415
				35	7	anodowany	20	54532









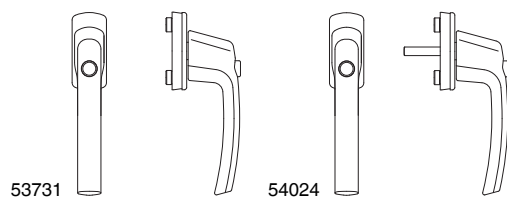

4.3 Klamka z kluczykiem, 45°



4.3.1 Czopy 10/12								No
RAL 8019		55	28	0	7	mal. proszkowo	10	54142
				35	7	mal. proszkowo	10	53802
RAL 9016		55	28	0	7	mal. proszkowo	10	28868
				32	7	mal. proszkowo	10	28906
				35	7	mal. proszkowo	10	21381
jasnobrązowy		55	28	0	7	anodowany	10	28870
				32	7	anodowany	10	23322
				35	7	anodowany	10	21385
srebrny		55	28	0	7	anodowany	10	55822
				32	7	anodowany	10	54440
				35	7	anodowany	10	220630
srebrny (biała rozeta)		55	28	0	7	anodowany	10	54141
szampański		55	28	0	7	anodowany	10	28869
				32	7	anodowany	10	28900
				35	7	anodowany	10	21328
tytanowy		55	28	0	7	anodowany	10	28871
				32	7	anodowany	10	28903
				35	7	anodowany	10	21329

4.4 Klamka z przyciskiem, 45°







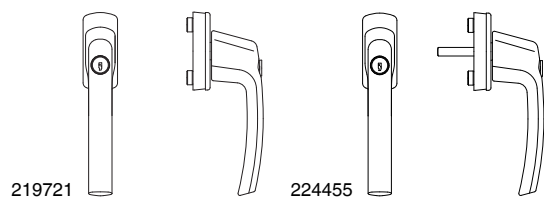

4.4.1 Czopy 10/12												No
RAL 8019	55	28	0	7	mal. proszkowo	10	220595					
RAL 9016	55	28	0	7	mal. proszkowo	10	53731					
			32	7	mal. proszkowo	10	54024					
			35	7	mal. proszkowo	10	54063					
jasnobrązowy	55	28	0	7	anodowany	10	53732					
			32	7	anodowany	10	54417					
			35	7	anodowany	10	54061					
srebrny	55	28	0	7	anodowany	10	54027					
			32	7	anodowany	10	55647					
			35	7	anodowany	10	55513					
srebrny (biała rozeta)	55	28	0	7	anodowany	10	54026					
szampański	55	28	0	7	anodowany	10	53730					
			32	7	anodowany	10	54023					
			35	7	anodowany	10	54060					
tytanowy	55	28	0	7	anodowany	10	53733					
			32	7	anodowany	10	54025					
			35	7	anodowany	10	54064					



4.5 Klamki do okien UR





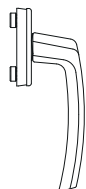

4.5.1 Czopy 10/12								No
RAL 8019	55 28	0	7	mal. proszkowo	10	219722		
		35	7	mal. proszkowo	10	219715		
RAL 9016	55 28	0	7	mal. proszkowo	10	219721		
		32	7	mal. proszkowo	10	224455		
		35	7	mal. proszkowo	10	219568		
		38	7	mal. proszkowo	10	224414		
		40	7	mal. proszkowo	10	224423		
jasnobrązowy	55 28	35	7	anodowany	10	219713		
		40	7	anodowany	10	224425		
srebrny	55 28	0	7	anodowany	10	219716		
		32	7	anodowany	10	224459		
		35	7	anodowany	10	219223		
		38	7	anodowany	10	224411		
		40	7	anodowany	10	224427		
szampański	55 28	43	7	anodowany	10	224437		
		35	7	anodowany	10	219711		
tytanowy	55 28	38	7	anodowany	10	224412		
		0	7	anodowany	10	219720		
		35	7	anodowany	10	219714		
		38	7	anodowany	10	224421		
		40	7	anodowany	10	224428		
złotyF3	55 28	43	7	anodowany	10	224446		
		55 28	35 7	anodowany	10	219712		

4.6 Komplet klamek z rozetami



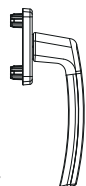

11072

4.6.1 Klamka wewnętrzna, czopy 12							N ^o
RAL 8022	PZ	55	28	7	anodowany	10	100540
RAL 9016	PZ	55	28	7	powlekany PVC	10	11072
jasnobrązowy	PZ	55	28	7	anodowany	10	11073
srebrny	PZ	55	28	7	anodowany	10	11075
srebrny (biała rozeta)	PZ	55	28	7	anodowany	10	100585
szampański	PZ	55	28	7	anodowany	10	11071
tytanowy	PZ	55	28	7	anodowany	10	11074



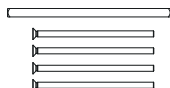

105667

4.6.2 Klamka zewnętrzna wysoka, czopy 12				N ^o
RAL 8019	PZ	mal. proszkowo	10	105663
RAL 8022	PZ	anodowany	10	105664
RAL 9016	PZ	mal. proszkowo	10	105667
jasnobrązowy	PZ	anodowany	10	105661
srebrny	PZ	anodowany	10	105665
szampański	PZ	anodowany	10	105662
tytanowy	PZ	anodowany	10	105666



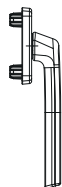

105749

4.6.3 Szyft i wkręty do kompletu klamki z rozetą wysokiej				N ^o
Szyft i śruby do kompletów klamek wysokich i niskich		67,5-76	10	105746
		76-86	10	105747
		86-96	10	105748
		96-106	10	105749



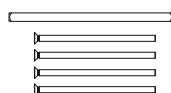

105674

4.6.4 Klamka zewnętrzna niska, czopy 12				№
RAL 8019	PZ	mał. proszkowo	10	105670
RAL 8022	PZ	anodowany	10	105671
RAL 9016	PZ	mał. proszkowo	10	105674
jasnobrązowy	PZ	anodowany	10	105668
srebrny	PZ	anodowany	10	105672
szampański	PZ	anodowany	10	105669
tytanowy	PZ	anodowany	10	105673





105749

4.6.5 Szyft i wkręty do kompletu klamki z rozetą wysokiej				№
Szyft i śruby do kompletów klamek wysokich i niskich		67,5-76	10	105746
		76-86	10	105747
		86-96	10	105748
		96-106	10	105749



105681

4.6.6 Klamka zewnętrzna płaska, czopy 12				№
RAL 8019	PZ	mał. proszkowo	10	105677
RAL 8022	PZ	anodowany	10	105678
RAL 9016	PZ	mał. proszkowo	10	105681
jasnobrązowy	PZ	anodowany	10	105675
srebrny	PZ	anodowany	10	105679
szampański	PZ	anodowany	10	105676
tytanowy	PZ	anodowany	10	105680

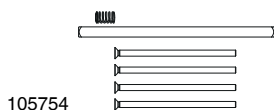

105754

4.6.7 Sztyft i wkręty do kompletu klamki z rozetą płaskiej



№

Sztyft, śruby i sprężyna do kompletów klamek płaskich

64-72	10	105750
72-82	10	105751
82-92	10	105752
92-102	10	105753
102-112	10	105754

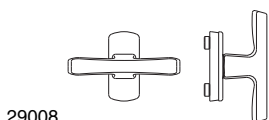

29008

4.7 Klamka krzyżowa, czopy 10/12



№

RAL 8022	28	7	anodowany	20	220636
RAL 9016	28	7	mal. proszkowo	20	29008
jasnobrązowy	28	7	anodowany	20	220635
srebrny	28	7	anodowany	20	55746
szampański	28	7	anodowany	20	29010
tytanowy	28	7	anodowany	20	29009



52202

4.8 Rozeta z klapką, czopy 10/12



№

RAL 8022	28		anodowany	20	28653
RAL 9016	28		mal. proszkowo	20	52202
jasnobrązowy	28		anodowany	20	28656
srebrny	28		anodowany	20	20506
srebrny (biała rozeta)	28		anodowany	20	54161
szampański	28		anodowany	20	28657
tytanowy	28		anodowany	20	28651

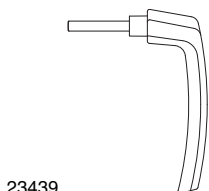

23439

4.9 Klamka wtykowa





№

RAL 9016	43	7	mal. proszkowo	20	23439
srebrny	43	7	anodowany	20	54341
szampański	43	7	anodowany	20	27411



42071



4.10 Podkładka do rozety Harmony		B		N_o
RAL 9016	3	28	100	42071
srebrny	3	28	100	220086
szampański	3	28	100	42074
tytanowy	3	28	100	42073



5 SYMPHONY





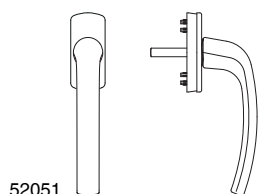

5.1	Klamka	34
5.2	Klamka z kluczykiem, 45°	35
5.3	Klamka z kluczykiem, 45°	35
5.4	Klamka z przyciskiem, 45°	36
5.5	Komplet klamek z rozetami	37
5.6	Rozeta z klapką, czopy 10/12	39
5.7	Klamka wtykowa	39
5.8	Podkładka do rozety Harmony	39

5 SYMPHONY

5.1 Klamka







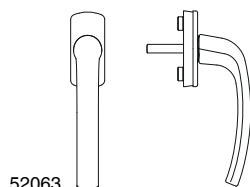

52051

5.1.1 Czopy 10							No
RAL 8019	57	28	32	7	powlekany PVC	20	54036
			35	7	powlekany PVC	20	54038
RAL 9016	57	28	32	7	powlekany PVC	20	52051
			35	7	powlekany PVC	20	52055
jasnobrązowy	57	28	32	7	anodowany	20	52053
			35	7	anodowany	20	52056
srebrny	57	28	32	7	anodowany	20	54030
			35	7	anodowany	20	54031
szampański	57	28	32	7	anodowany	20	52050
			35	7	anodowany	20	52054
tytanowy	57	28	32	7	anodowany	20	52052
			35	7	anodowany	20	52057







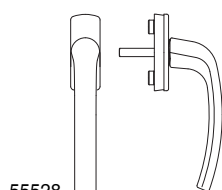

52063

5.1.2 Czopy 10/12							No
RAL 8019	57	28	0	7	powlekany PVC	20	220603
RAL 9016	57	28	32	7	powlekany PVC	20	52063
			35	7	powlekany PVC	20	52067
jasnobrązowy	57	28	32	7	anodowany	20	52064
			35	7	anodowany	20	52068
srebrny	57	28	35	7	anodowany	20	54033
szampański	57	28	32	7	anodowany	20	52062
tytanowy	57	28	32	7	anodowany	20	52065
			35	7	anodowany	20	52069



55528

5.1.3 Czopy 10/12 z wąską rozetą							No
RAL 9016	57	24	35	7	powlekany PVC	20	55528
tytanowy	57	24	32	7	anodowany	20	55523

5.2 Klamka z kluczykiem, 45°

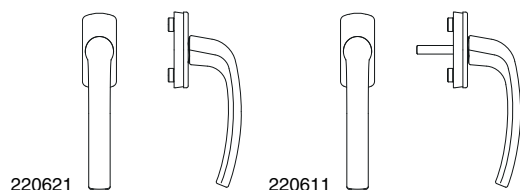

5.2.1 Czopy 10/12									No
RAL 8019	57	28	35	7	powlekany PVC	20			220615
RAL 9016	57	28	0	7	powlekany PVC	20			220621
			32	7	powlekany PVC	20			220611
			35	7	powlekany PVC	20			220614
jasnobrązowy	57	28	0	7	anodowany	20			220624
srebrny	57	28	0	7	anodowany	20			220628
			35	7	anodowany	20			59192
			0	7	anodowany	20			220623
szampański	57	28	0	7	anodowany	20			220625
tytanowy	57	28	0	7	anodowany	20			220625
			35	7	anodowany	20			220618

5.3 Klamka z kluczykiem, 45°

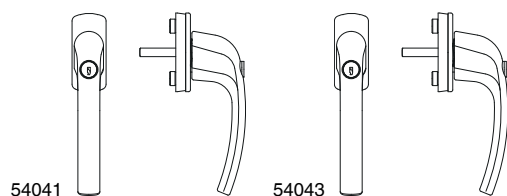





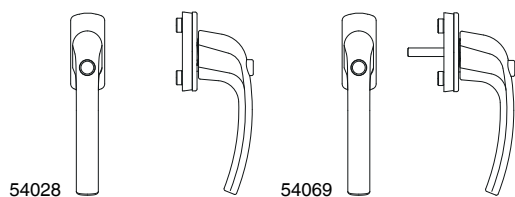

5.3.1 Czopy 10/12									No
RAL 8019	57	28	0	7	mal. proszkowo	10			54029
RAL 9016	57	28	35	7	mal. proszkowo	10			54041
srebrny	57	28	0	7	anodowany	10			54034
			35	7	anodowany	10			54410
szampański	57	28	0	7	anodowany	10			52088
tytanowy	57	28	0	7	anodowany	10			52091
			35	7	anodowany	10			54043



5.4 Klamka z przyciskiem, 45°





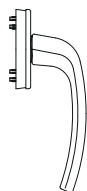

5.4.1 Czopy 10/12								No
RAL 8019		57	28	0	7	mal. proszkowo	10	54028
RAL 9016		57	28	35	7	mal. proszkowo	10	54069
srebrny		57	28	35	7	anodowany	10	54065
tytanowy		57	28	35	7	anodowany	10	54070

5.5 Komplet klamek z rozetami





11063

5.5.1 Klamka wewnętrzna, czopy 12							№
RAL 9016	PZ	57	28	7	powlekany PVC	10	11063
jasnobrązowy	PZ	57	28	7	anodowany	10	11064
srebrny	PZ	57	28	7	anodowany	10	11067
szampański	PZ	57	28	7	anodowany	10	11062
tytanowy	PZ	57	28	7	anodowany	10	11065



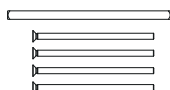

105686

5.5.2 Klamka zewnętrzna wysoka, czopy 12				№
RAL 9016	PZ	mal. proszkowo	10	105686
jasnobrązowy	PZ	anodowany	10	105682
srebrny	PZ	anodowany	10	105684
szampański	PZ	anodowany	10	105683
tytanowy	PZ	anodowany	10	105685



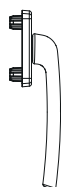

105749

5.5.3 Szyft i wkręty do kompletu klamki z rozetą wysokiej				№
Szyft i śruby do kompletów klamek wysokich i niskich		67,5-76	10	105746
		76-86	10	105747
		86-96	10	105748
		96-106	10	105749



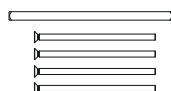

105691

5.5.4 Klamka zewnętrzna niska, czopy 12				N^o
RAL 9016	PZ	mal. proszkowo	10	105691
jasnobrązowy	PZ	anodowany	10	105687
srebrny	PZ	anodowany	10	105689
szampański	PZ	anodowany	10	105688
tytanowy	PZ	anodowany	10	105690





105749

5.5.5 Szyft i wkręty do kompletu klamki z rozetą wysokiej				N^o
Szyft i śruby do kompletów klamek wysokich i niskich		67,5-76	10	105746
		76-86	10	105747
		86-96	10	105748
		96-106	10	105749



105675

5.5.6 Klamka zewnętrzna płaska, czopy 12				N^o
RAL 8019	PZ	mal. proszkowo	10	105677
RAL 8022	PZ	anodowany	10	105678
RAL 9016	PZ	mal. proszkowo	10	105681
jasnobrązowy	PZ	anodowany	10	105675
srebrny	PZ	anodowany	10	105679
szampański	PZ	anodowany	10	105676
tytanowy	PZ	anodowany	10	105680

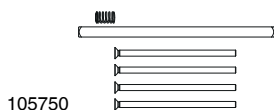

105750

5.5.7 Szyft i wkręty do kompletu klamki z rozetą płaskiej



N_o

Szyft, śruby i sprężyna do kompletów klamek płaskich

64-72	10	105750
72-82	10	105751
82-92	10	105752
92-102	10	105753
102-112	10	105754



52202

5.6 Rozeta z klapką, czopy 10/12



N_o

RAL 8022	28	anodowany	20	28653
RAL 9016	28	mal. proszkowo	20	52202
jasnobrązowy	28	anodowany	20	28656
srebrny	28	anodowany	20	20506
srebrny (biała rozeta)	28	anodowany	20	54161
szampański	28	anodowany	20	28657
tytanowy	28	anodowany	20	28651

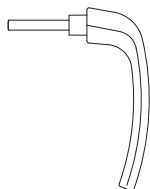

54014

5.7 Klamka wtykowa



N_o

RAL 9016	43	7	mal. proszkowo	20	54014
szampański	43	7	anodowany	20	54013



42071

5.8 Podkładka do rozety Harmony



B



N_o

RAL 9016	3	28	100	42071
srebrny	3	28	100	220086
szampański	3	28	100	42074
tytanowy	3	28	100	42073

MACO
EMOTION



SYMPHONY



6 Unity

6.1	Klamka	42
6.2	Klamka z kluczykiem	43

6 Unity

6.1 Klamka

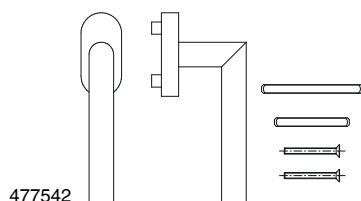

477542

6.1.1 Klamka B02



No

stal szlachetna matowa

M5x45

69

33

24 / 32

36 / 42

7

1

477542

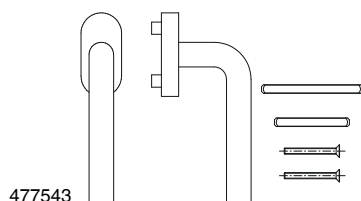

477543

6.1.2 Klamka B03



No

stal szlachetna matowa

M5x45

73

33

24 / 32

36 / 42

7

1

477543

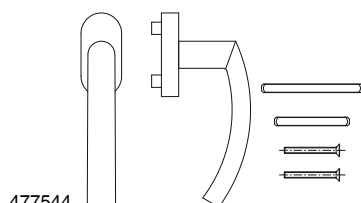

477544

6.1.3 Klamka B07

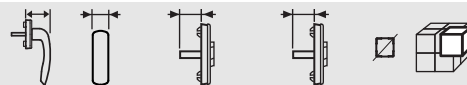

No

stal szlachetna matowa

M5x45

72,5

33

24 / 32

36 / 42

7

1

477544

6.2 Klamka z kluczykiem

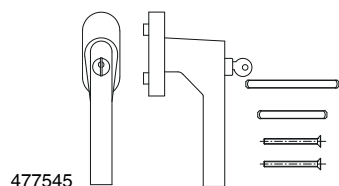

477545

6.2.1 Klamka z kluczykiem B02



No

stal szlachetna matowa

M5x50

67

33

24 / 31

36 / 42

7

1

477545

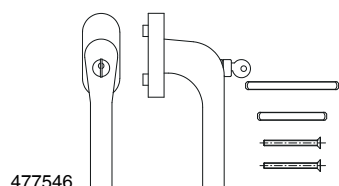

477546

6.2.2 Klamka z kluczykiem B03



No

stal szlachetna matowa

M5x50

67

33

24 / 31

36 / 42

7

1

477546

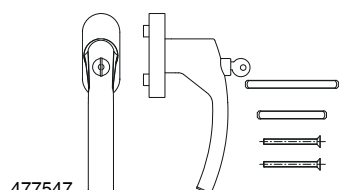

477547

6.2.3 Klamka z kluczykiem B07



No

stal szlachetna matowa

M5x50

69,5

33

24 / 31

36 / 42

7

1

477547



MACO
EMOTION



Unity



7 TRESOR





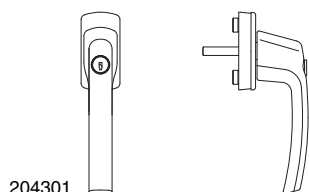

- 7.1 Klamka z kluczykiem, do okien utrudniających włamanie wg norm PN EN 1627-30, RC1-RC3 _____ 46
- 7.2 Klamka z kluczykiem 45°, do okien z podstawowym zabezpieczeniem _____ 47
- 7.3 Klamka z przyciskiem, do okien utrudniających włamanie wg norm PN EN 1627-30, WK1-WK3 _____ 48

7 TRESOR

7.1 Klamka z kluczykiem, do okien utrudniających włamanie wg norm PN EN 1627-30, RC1-RC3







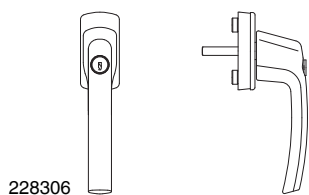

204301

7.1.1 Czopy 10/12							No
RAL 8019	58	32	32	7	mal. proszkowo	10	58935
			35	7	mal. proszkowo	10	58932
			38	7	mal. proszkowo	10	216849
RAL 9016	58	32	32	7	mal. proszkowo	10	58933
			35	7	mal. proszkowo	10	55280
			38	7	mal. proszkowo	10	204301
			40	7	mal. proszkowo	10	207285
			43	7	mal. proszkowo	10	216834
jasnobrązowy	58	32	32	7	lakierowane	10	58980
			35	7	lakierowane	10	55711
			38	7	lakierowane	10	208138
srebrny	58	32	32	7	lakierowane	10	58934
			35	7	lakierowane	10	58876
			38	7	lakierowane	10	208136
			40	7	lakierowane	10	207286
			43	7	lakierowane	10	215362
srebrny (biała rozeta)	58	32	35	7	lakierowane	10	55709
szampański	58	32	32	7	lakierowane	10	58981
			35	7	lakierowane	10	55710
tytanowy	58	32	32	7	lakierowane	10	58988
			35	7	lakierowane	10	55712
			38	7	lakierowane	10	208143
			40	7	lakierowane	10	216187
			43	7	lakierowane	10	216833

7.2 Klamka z kluczykiem 45°, do okien z podstawowym zabezpieczeniem

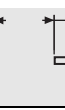

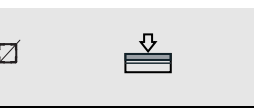
228306







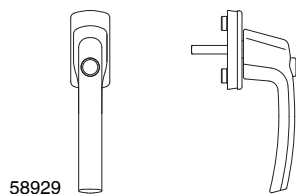

<p>7.2.1 Czopy 10/12</p>							
<p>RAL 9016</p>	<p>58</p>	<p>32</p>	<p>35</p>	<p>7</p>	<p>mal. proszkowo</p>	<p>10</p>	<p>228306</p>



7.3 Klamka z przyciskiem, do okien utrudniających włamanie wg norm PN EN 1627-30, WK1-WK3



58929

7.3.1 Czopy 10/12									No
RAL 8019	58	32	35	7	mal. proszkowo	10	58928		
			43	7	mal. proszkowo	10	216844		
RAL 9016	58	32	32	7	mal. proszkowo	10	58929		
			35	7	mal. proszkowo	10	55270		
			38	7	mal. proszkowo	10	209361		
			40	7	mal. proszkowo	10	207282		
			43	7	mal. proszkowo	10	224727		
jasnobrązowy	58	32	32	7	lakierowane	10	58984		
			35	7	lakierowane	10	55707		
			40	7	lakierowane	10	207284		
srebrny	58	32	32	7	lakierowane	10	58930		
			35	7	lakierowane	10	58875		
			38	7	lakierowane	10	209357		
			40	7	lakierowane	10	207283		
			43	7	lakierowane	10	224729		
szampański	58	32	32	7	lakierowane	10	58985		
			35	7	lakierowane	10	55706		
tytanowy	58	32	32	7	lakierowane	10	58989		
			35	7	lakierowane	10	55708		
			38	7	lakierowane	10	209360		
			40	7	lakierowane	10	215359		
			43	7	lakierowane	10	224728		



8 Klamka z kutego żelaza

8.1	Klamka	50
-----	--------	----



8 Klamka z kutego żelaza

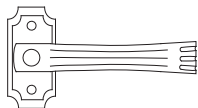

10517

8.1 Klamka



N_o

S30

10

10517



9 Pochwyty balkonowe



9.1	Aluminiowe	52
9.2	PVC	52

9 Pochwyty balkonowe

9.1 Aluminiowe





30719

9.1.1 BASE			N ^o
RAL 8022	anodowany	20	39589
RAL 9016	mal. proszkowo	20	30719
jasnobrązowy	anodowany	20	38162
srebrny	anodowany	20	36870
szampański	anodowany	20	30290
tytanowy	anodowany	20	38163





220536

9.1.2 SOFT-L			N ^o
RAL 8022	anodowany	15	220743
RAL 9016	mal. proszkowo	20	220536
jasnobrązowy	anodowany	15	220739
srebrny	anodowany	15	97507
szampański	anodowany	15	220740
tytanowy	anodowany	15	97508





59150

9.1.3 SOFT			N ^o
RAL 8022	anodowany	20	220744
RAL 9016	mal. proszkowo	20	59150
jasnobrązowy	anodowany	20	59147
srebrny	anodowany	20	59148
szampański	anodowany	20	59149
tytanowy	anodowany	20	59146

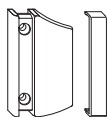
9.2 PVC



10599

9.2.1 LIGHT			N ^o
RAL 8019	PVC	20	10600
RAL 9016	PVC	20	10599





10 Dodatki EMOTION

10.1	Sztyft _____	54
10.2	Sztyft do klamek z rozetami _____	54
10.3	Sztyft do klamek do zasuwnic B-TV _____	54
10.4	Pierścień kombi dla czopów 10/12 _____	54
10.5	Klucz do klamek _____	54





10 Dodatki EMOTION

39013 

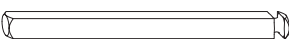
10.1 Sztyft	L				N ^o
Sztyft	52	26	7	200	39013
	56	30	7	200	39029
	61	35	7	200	30717
	64	38	7	20	94228
	69	43	7	200	39014
	76	50	7	200	30765

363639 

10.2 Sztyft do klamek z rozetami	L			N ^o
Sztyft	162	7	50	363639

363640 

10.3 Sztyft do klamek do zasuwnic B-TV	L			N ^o
Sztyft	162	8	50	363640

40017 

10.4 Pierścień kombi dla czopów 10/12		N ^o
Pierścień Kombi do czopów DM9,6 i 11,6	500	40017

42600 

10.5 Klucz do klamek		N ^o
Klucz do klamek srebrny	10	42600





11 Index

N^o		Strona
1		
100540	10	29
100585	10	29
10517	10	50
105646	10	19
105647	10	19
105648	10	19
105649	10	19
105650	10	19
105651	10	20
105652	10	20
105653	10	20
105654	10	20
105655	10	20
105656	10	20
105657	10	20
105658	10	20
105659	10	20
105660	10	20
105661	10	29
105662	10	29
105663	10	29
105664	10	29
105665	10	29
105666	10	29
105667	10	29
105668	10	30
105669	10	30
105670	10	30
105671	10	30
105672	10	30
105673	10	30
105674	10	30
105675	10	30, 38
105676	10	30, 38
105677	10	30, 38
105678	10	30, 38
105679	10	30, 38
105680	10	30, 38
105681	10	30, 38
105682	10	37
105683	10	37
105684	10	37
105685	10	37
105686	10	37
105687	10	38
105688	10	38
105689	10	38
105690	10	38
105691	10	38
105746	10	19, 20, 29, 30, 37, 38
105747	10	19, 20, 29, 30, 37, 38
105748	10	19, 20, 29, 30, 37, 38
105749	10	19, 20, 29, 30, 37, 38
105750	10	21, 31, 39
105751	10	21, 31, 39
105752	10	21, 31, 39
105753	10	21, 31, 39
105754	10	21, 31, 39
10599	20	52
10600	20	52
11062	10	37
11063	10	37
11064	10	37
11065	10	37
11067	10	37
11071	10	29
11072	10	29
11073	10	29
11074	10	29
11075	10	29
14603	10	19
14604	10	19
14605	10	19
14606	10	19
14607	10	19
2		
20415	20	26
204301	10	46
20506	20	31, 39
205152	20	26
20695	20	24
207282	10	48
207283	10	48
207284	10	48
207285	10	46
207286	10	46
208136	10	46

N^o		Strona
208138	10	46
208143	10	46
209357	10	48
209360	10	48
209361	10	48
21214	20	26
21328	10	26
21329	10	26
21381	10	26
21385	10	26
215359	10	48
215362	10	46
216187	10	46
216833	10	46
216834	10	46
216844	10	48
216849	10	46
219222	10	18
219223	10	28
219568	10	28
219711	10	28
219712	10	28
219713	10	28
219714	10	28
219715	10	28
219716	10	28
219720	10	28
219721	10	28
219722	10	28
219739	10	18
219740	10	18
219742	10	18
219743	10	18
219746	10	18
219747	10	18
219748	10	18
220086	100	32, 39
220536	20	52
220595	10	27
220596	20	26
220597	20	26
220598	20	26
220602	20	26
220603	20	34
220611	20	35
220614	20	35
220615	20	35
220618	20	35
220621	20	35
220623	20	35
220624	20	35
220625	20	35
220628	20	35
220629	20	26
220630	10	26
220635	20	31
220636	20	31
220739	15	52
220740	15	52
220743	15	52
220744	20	52
224075	10	18
224079	10	18
224080	10	18
224081	10	18
224082	10	18
224411	10	28
224412	10	28
224414	10	28
224421	10	28
224423	10	28
224425	10	28
224427	10	28
224428	10	28
224437	10	28
224446	10	28
224453	10	18
224455	10	28
224459	10	28
224462	10	18
224464	10	18
224727	10	48
224728	10	48
224729	10	48
228306	10	47
229038	20	15
229039	20	15
229040	20	15
229041	20	15
229042	20	15

N^o		Strona
229043	50	15
23177	20	26
23213	20	26
23223	20	26
23273	20	26
23322	10	26
23439	20	31
27411	20	31
28651	20	31, 39
28653	20	31, 39
28656	20	31, 39
28657	20	31, 39
28719	20	24
28738	20	24
28854	20	24
28855	20	24
28856	20	24
28857	20	24
28861	20	24
28868	10	26
28869	10	26
28870	10	26
28871	10	26
28898	20	24
28900	10	26
28901	20	24
28902	20	24
28903	10	26
28906	10	26
29008	20	31
29009	20	31
29010	20	31
3		
30290	20	52
30717	200	54
30719	20	52
30765	200	54
363639	50	54
363640	50	54
36870	20	52
38162	20	52
38163	20	52
39013	200	54
39014	200	54
39029	200	54
39589	20	52
4		
40017	500	54
42071	100	32, 39
42073	100	32, 39
42074	100	32, 39
42600	10	54
461769	1	12
461770	1	12
461771	1	12
461772	1	12
461773	1	12
461889	1	12
477542	1	42
477543	1	42
477544	1	42
477545	1	43
477546	1	43
477547	1	43
5		
51650	20	26
51726	20	24
51750	20	24
51763	20	24
51822	20	26
51856	20	24
51974	20	24
51987	20	24
52050	20	34
52051	20	34
52052	20	34
52053	20	34
52054	20	34
52055	20	34
52056	20	34
52057	20	34
52062	20	34
52063	20	34
52064	20	34
52065	20	34
52067	20	34
52068	20	34



№		Strona	№		Strona	
52069		20	58985		10	48
52088		10	58988		10	46
52091		10	58989		10	48
52116		20	59146		20	52
52202		20	59147		20	52
53730		10	59148		20	52
53731		10	59149		20	52
53732		10	59150		20	52
53733		10	59192		20	35
53802		10	59500		20	14
53839		20	59501		20	14
53840		20	59502		20	14
53972		20	59503		20	14
53979		20	59504		20	14
54013		20	59505		20	14
54014		20	59506		20	14
54023		10	59507		20	14
54024		10	59508		20	14
54025		10	59509		20	14
54026		10	59510		20	14
54027		10	59511		20	14
54028		10	59512		20	14
54029		10	59513		20	14
54030		20	59514		20	14
54031		20	59515		20	14
54033		20	59516		20	14
54034		10	59517		20	14
54036		20	59518		20	14
54038		20	59519		20	14
54041		10	59520		20	14
54043		10	59521		20	14
54060		10	59522		20	14
54061		10	59523		20	14
54063		10	59524		20	14
54064		10	59525		20	14
54065		10	59526		20	14
54069		10	59527		20	14
54070		10	59529		20	14
54114		20	59555		20	15
54115		20	59556		20	15
54116		20	59557		20	15
54117		20	59558		20	15
54119		20	59559		20	15
54124		20	59565		20	15
54129		20	59567		20	15
54132		20	59569		20	15
54133		20	59570		20	15
54141		10	59571		20	15
54142		10	59572		20	15
54161		20	59573		20	15
54171		20	59574		20	15
54341		20	59575		20	15
54410		10	59576		20	15
54417		10	59577		20	15
54425		20	59578		20	15
54440		10	59579		20	15
54521		20	59602		10	16
54532		20	59604		10	16
55270		10	59606		10	16
55280		10	59612		10	16
55508		20	59614		10	16
55510		20	59616		10	16
55511		20	59622		10	16
55512		20	59623		10	16
55513		10	59624		10	16
55516		20	59625		10	16
55517		20	59626		10	16
55518		20	59632		10	17
55523		20	59634		10	17
55528		20	59642		10	17
55647		10	59644		10	17
55706		10	59646		10	17
55707		10	59652		10	17
55708		10	59653		10	17
55709		10	59654		10	17
55710		10	59655		10	17
55711		10	59656		10	17
55712		10	59770		20	21
55713		20	59771		20	21
55746		20	59772		20	21
55821		20	59773		20	21
55822		10	59774		20	21
58875		10	59780		20	21
58876		10	59790		20	21
58928		10	59792		20	21
58929		10	59793		20	21
58930		10	59794		20	21
58932		10				
58933		10				
58934		10				
58935		10				
58976		20				
58980		10				
58981		10				
58984		10				
			9			
			94228		20	54
			97507		15	52
			97508		15	52

**MACO
EMOTION**



MACO POLSKA SP. Z O.O.

ul Gutenberga 18
44-109 Gliwice
Polska

Tel.: +48 (32) 30 12 330
E-Mail: maco@maco.pl
www.maco.pl

Są Państwo zadowoleni?

Czekamy na Państwa opinie
feedback@maco.eu

Nr. 750353PL – Data: maj 2018
Wszelkie prawa zastrzeżone.

Treść niniejszej broszury jest stale weryfikowana.
Aktualną wersję można znaleźć pod adresem
<http://www.maco.eu/sites/assets/MacoDocs/750353/750353pl.pdf>
Lub proszę zeskanować QR – kod.

