



TECHNOLOGY IN MOTION









MACO ESPAGS

ESPAGNOLETTES



CATALOGUE APAC & MEA

Symbols

	Item number		Number of required combi striker plates
	Packing unit		Sash rebate width (SRW) and sash rebate height (SRH)
	Number of required night-vent striker plates	L	Overall component length
	Number of required shootbolt striker plates	W	Overall component width
	Number of required French Casement Strikers		Cam height

Note: If not otherwise specified, all dimensions are stated in millimetres and packing units in items per box.

1	Technical and general information	<i>i</i>	5
<hr/>			
2	R.A.I.L.	2	9
<hr/>			
3	INLINE	3	13
<hr/>			
4	OFFSET	4	17
<hr/>			
5	Striker plates	5	21
<hr/>			
6	Directory		
<hr/>			

1 Technical and general information

1.1	How to use the catalogue	6
1.2	Certificates and guarantees	6
1.3	Product Liability	6
1.4	General Terms and Conditions	7
1.5	Profile specifications	7

1 Technical and general information

1.1 How to use the catalogue

If not otherwise specified, all dimensions are stated in millimetres and packing units in items per box.

Drawings and diagrams are not to scale.

The content of this document is constantly being updated, so regular comparison is necessary (see date on the back of the catalog).

The current version is downloadable from our website (www.maco.eu).

Further technical documents are available in our Technical Online Catalogue TOM (extranet.maco.eu).

No liabilities are accepted for possible printing errors, mistakes or changes.

Please send comments or suggestions about our catalogues by email to feedback@maco.eu.

1.2 Certificates and guarantees

MACO ensures high quality, not only with ongoing continuous internal testing, but also through external auditing by renowned, independent institutes. Copies of all our current independent test certificates, covering our quality, safety and environmental management systems, as well as our product

guarantees are available to download from our website www.maco.eu. In addition our safety descriptions relating to dangerous substances (RoHS and REACH Declaration) are available, covering all MACO products.

1.3 Product Liability

“ESPAGS“ Window Espagnolettes

In accordance with the manufacturers liability for of his products, which is defined in the “Product Liability Law“ (§ 1 PHG), the following information is binding and should be considered for the entire “Espags“ espagnolette product range. Non compliance shall relieve the manufacturer of all liability.

1. PRODUCT INFORMATION AND CONVENTIONAL USE

In terms of this definition, the espagnolette product range includes (window sash and frame) fittings for timber, PVC-u and aluminium and their corresponding material combinations.

1.1 Inline and Offset espagnolettes

When closing and locking the window one or more adjustable mushroom bolts engage into striker plates. The espagnolette is activated by turning the handle through 90°.

1.2 Shootbolt espagnolettes

When closing and locking the window a combination of adjustable mushroom bolts and end shootbolts engage into striker plates. The espagnolette is activated by turning the handle through 90°.

1.3 R.A.I.L. espagnolettes

When closing and locking the window one or more pairs of adjustable mushroom bolts engage together into striker plates. The espagnolette is activated by turning the handle through 90°.

2. PRODUCT INSTALLATION

MACO espagnolettes should only be fitted by specialists. The MACO espagnolette must be able to be fitted easily into the recesses made in the window sash. Any components forced into the recess can impair the functionality of the espagnolette fitting.

The espagnolette must be screwed onto the window using appropriate tools that have a torque function.

The striker plates (mushroom, shootbolt and combination (combi)) must be fitted in such a way that they allow the espagnolette locking points to enter unhindered. Any component forced into a striker plate can impair the functionality of the espagnolette locking system.

To ensure the correct function of the mushroom striker plates they contain notches on the face that correspond to the centre of the mushroom bolt, which designate the optimal position of the striker plate. Shootbolt striker plates should be inserted into a mushroom strike and together they are located into the corners of the frame. When using combination (combi) striker plates these are simply located into the corners of the frame.

The striker plates must be screwed onto the frame using appropriate screws for the correct application with tools that have a torque function.

3. PRODUCT MAINTENANCE

In order to ensure perfect functionality of MACO window es-
pagnolettes

- the necessary information and instructions are to be transferred to the appropriate persons;
- the applicable standards are to be observed;
- MACO espagnolettes must be used according to their defined function;
- the manufacturer's regulations concerning the configuration of the fittings are to be observed;
- maintenance and care instructions are to be followed;
- faults may only be repaired by specialist personnel.

4. PRODUCT PERFORMANCE

Unless the product performances and explicitly specified in our catalogues and brochures, the requirements of the individual locking system must be agreed with us.

The information concerning product performance solely refers to the combination of MACO original parts.

The efficiency of locking systems depends on, among other things, frequency of use, method of operation, environmental influences, maintenance and care.



1.4 General Terms and Conditions

Our current general terms and conditions are available for download from our website (www.maco.eu).

1.5 Profile specifications

1.5.1 Eurogroove

For installation of turn-only and turn&tilt hardware the Eurogroove must be designed according to the following specifications:

Eurogroove

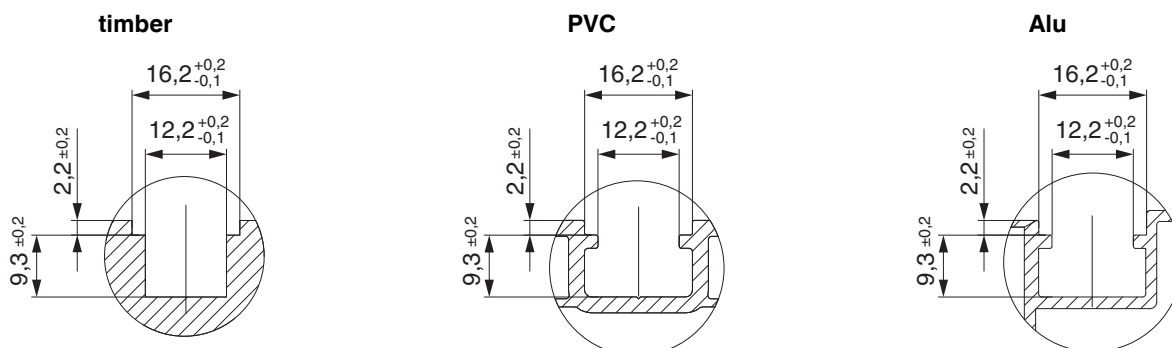

Shallow Eurogroove

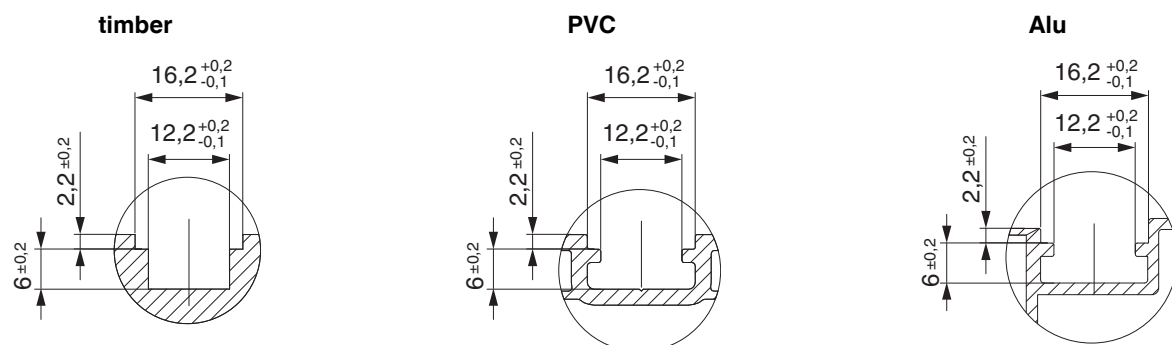

Technical and general information

2 R.A.I.L.



2.1	Espagnolettes, backset 20 mm	10
2.2	Espagnolettes, backset 22 mm	11

2 R.A.I.L.

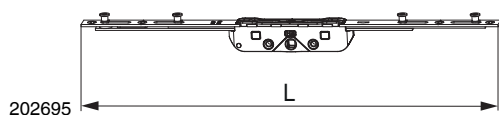
2.1 Espagnolettes, backset 20 mm



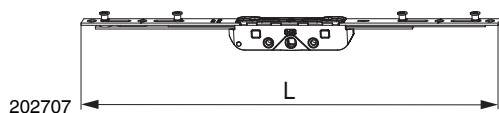

2.1.1 Mushroom height 7.7 mm

		L				No	No Tricoat
silver	Size 1	200	200 - 400	1	10	202693	
	Size 2	400	401 - 600	2	10	202694	
	Size 3	600	601 - 800	2	10	202695	
	Size 4	800	801 - 1.000	3	10	202696	
	Size 5	1.000	1.001 - 1.200	3	10	202697	
	Size 6	1.200	1.201 - 1.400	3	10	202698	





2.1.2 Mushroom height 9.0 mm

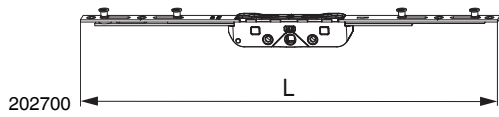

		L				No	No Tricoat
silver	Size 1	200	200 - 400	1	10	202705	
	Size 2	400	401 - 600	2	10	202706	
	Size 3	600	601 - 800	2	10	202707	
	Size 4	800	801 - 1.000	3	10	202708	
	Size 4A	900	901 - 1.100	3	10	208809	
	Size 5	1.000	1.001 - 1.200	3	10	202709	
	Size 5A	1.100	1.101 - 1.300	3	10	208810	
Size 6	1.200	1.201 - 1.400	3	10	202710		

2.2 Espagnolettes, backset 22 mm

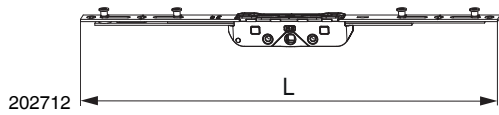

2.2.1 Mushroom height 7.7 mm		L				No	No Tricoat
silver	Size 1	200	200 - 400	1	10	202699	
	Size 2	400	401 - 600	2	10	202700	
	Size 3	600	601 - 800	2	10	202701	
	Size 4	800	801 - 1.000	3	10	202702	
	Size 5	1.000	1.001 - 1.200	3	10	202703	
	Size 6	1.200	1.201 - 1.400	3	10	202704	



2.2.2 Mushroom height 9.0 mm		L				No	No Tricoat
silver	Size 1	200	200 - 400	1	10	202711	
	Size 2	400	401 - 600	2	10	202712	
	Size 3	600	601 - 800	2	10	202713	
	Size 4	800	801 - 1.000	3	10	202714	
	Size 5	1.000	1.001 - 1.200	3	10	202715	
	Size 6	1.200	1.201 - 1.400	3	10	202716	

3 INLINE

3.1	Espagnolettes, backset 20 mm	14
3.2	Espagnolettes, backset 22 mm	15

3 INLINE

3.1 Espagnolettes, backset 20 mm

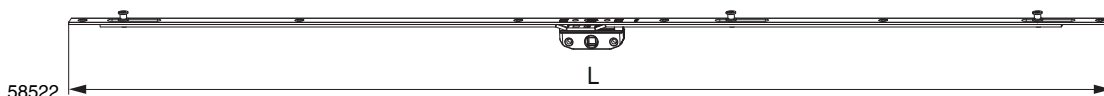

3.1.1 Mushroom height 7.7 mm		L				No	No Tricoat
silver	Size 0	260	260 - 400	2	20	58493	250359
	Size 1	400	401 - 600	2	20	58501	250360
	Size 2	600	601 - 800	2	20	58508	
	Size 3	800	801 - 1.000	2	20	58515	
	Size 4	1.000	1.001 - 1.200	3	20	58522	
	Size 5	1.200	1.201 - 1.400	3	10	58528	250358

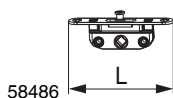

3.1.2 Single cam, mushroom height 7.7 mm		L			No	No Tricoat
silver		100	1	20	58486	

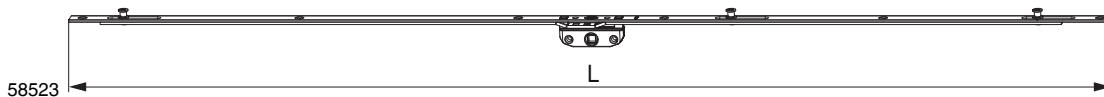

3.1.3 Mushroom height 9.0 mm		L				No	No Tricoat
silver	Size 0	260	260 - 400	2	20	58494	
	Size 1	400	401 - 600	2	20	58502	
	Size 2	600	601 - 800	2	20	58509	
	Size 3	800	801 - 1.000	2	20	58516	
	Size 4	1.000	1.001 - 1.200	3	20	58523	
	Size 5	1.200	1.201 - 1.400	3	10	58529	

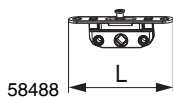

3.1.4 Single cam, mushroom height 9.0 mm		L			No	No Tricoat
silver		100	1	20	58488	

3.2 Espagnolettes, backset 22 mm

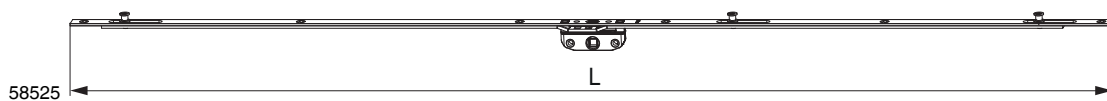

3.2.1 Mushroom height 7.7 mm

		L				No	No Tricoat
silver	Size 0	260	260 - 400	2	20	58496	
	Size 1	400	401 - 600	2	20	58504	
	Size 2	600	601 - 800	2	20	58511	
	Size 3	800	801 - 1.000	2	20	58518	
	Size 4	1.000	1.001 - 1.200	3	20	58525	
	Size 5	1.200	1.201 - 1.400	3	10	58530	

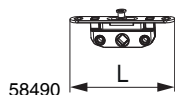

3.2.2 Single cam, mushroom height 7.7 mm

		L			No	No Tricoat
silver		100	1	20	58490	

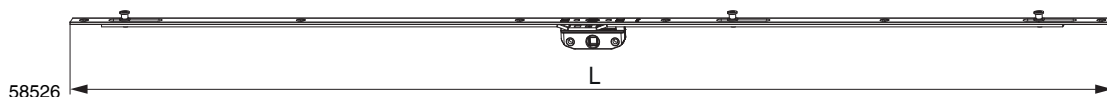

3.2.3 Mushroom height 9.0 mm

		L				No	No Tricoat
silver	Size 0	260	260 - 400	2	20	58497	
	Size 1	400	401 - 600	2	20	58505	
	Size 2	600	601 - 800	2	20	58512	
	Size 3	800	801 - 1.000	2	20	58519	
	Size 4	1.000	1.001 - 1.200	3	20	58526	
	Size 5	1.200	1.201 - 1.400	3	10	58531	

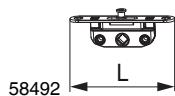

3.2.4 Single cam, mushroom height 9.0 mm

		L			No	No Tricoat
silver		100	1	20	58492	



4 OFFSET

4.1	Espagnolettes, backset 20 mm	18
4.2	Espagnolettes, backset 25 mm	19

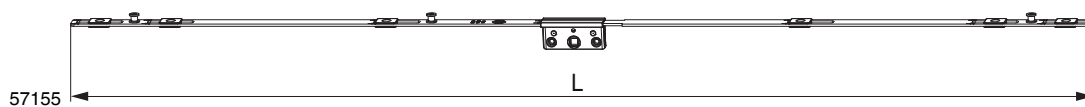

4 OFFSET

4.1 Espagnolettes, backset 20 mm

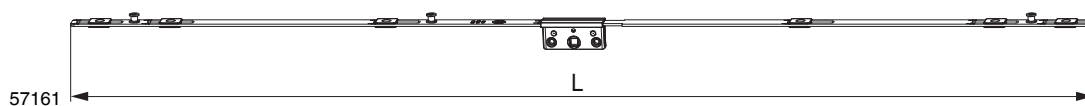

4.1.1 Mushroom height 7.7 mm		L				No	No Tricoat
silver	Size 0	291	310 - 510	2	20	57151	
	Size 1	381	400 - 600	2	20	57152	
	Size 2	581	601 - 800	2	20	57153	
	Size 3	781	801 - 1.000	2	20	57154	
	Size 4	981	1.001 - 1.200	3	20	57155	
	Size 5	1.181	1.201 - 1.400	3	20	57156	



4.1.2 Mushroom height 9.0 mm		L				No	No Tricoat
silver	Size 0	291	310 - 510	2	20	57157	
	Size 1	381	400 - 600	2	20	57158	
	Size 2	581	601 - 800	2	20	57159	
	Size 3	781	801 - 1.000	2	20	57160	
	Size 4	981	1.001 - 1.200	3	20	57161	
	Size 5	1.181	1.201 - 1.400	3	20	57162	

4.2 Espagnolettes, backset 25 mm

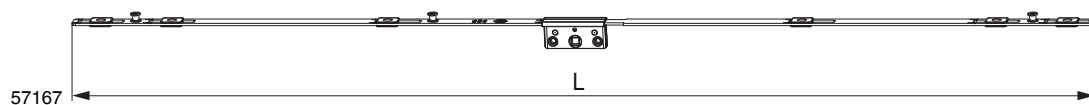

4.2.1 Mushroom height 7.7 mm

		L				No	No Tricoat
silver	Size 0	291	310 - 510	2	20	57163	
	Size 1	381	400 - 600	2	20	57164	
	Size 2	581	601 - 800	2	20	57165	
	Size 3	781	801 - 1.000	2	20	57166	
	Size 4	981	1.001 - 1.200	3	20	57167	
	Size 5	1.181	1.201 - 1.400	3	20	57168	

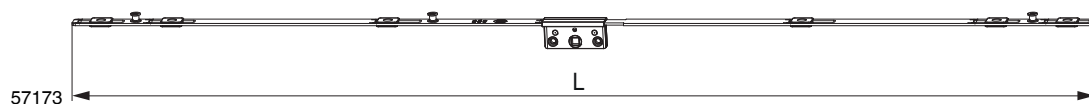

4.2.2 Mushroom height 9.0 mm

		L				No	No Tricoat
silver	Size 0	291	310 - 510	2	20	57169	
	Size 1	381	400 - 600	2	20	57170	
	Size 2	581	601 - 800	2	20	57171	
	Size 3	781	801 - 1.000	2	20	57172	
	Size 4	981	1.001 - 1.200	3	20	57173	
	Size 5	1.181	1.201 - 1.400	3	20	57174	

5 Striker plates

5.1 Product information _____ **22**

5 Striker plates

5.1 Product information

To order the correct striker type please refer to the latest profile datasheet.

6 Directory

№  **Page**

2

202693	10	10
202694	10	10
202695	10	10
202696	10	10
202697	10	10
202698	10	10
202699	10	11
202700	10	11
202701	10	11
202702	10	11
202703	10	11
202704	10	11
202705	10	10
202706	10	10
202707	10	10
202708	10	10
202709	10	10
202710	10	10
202711	10	11
202712	10	11
202713	10	11
202714	10	11
202715	10	11
202716	10	11
208809	10	10
208810	10	10
250358	10	14
250359	20	14
250360	20	14

5

57151	20	18
57152	20	18
57153	20	18
57154	20	18
57155	20	18
57156	20	18
57157	20	18
57158	20	18
57159	20	18
57160	20	18
57161	20	18
57162	20	18
57163	20	19
57164	20	19
57165	20	19
57166	20	19
57167	20	19
57168	20	19
57169	20	19
57170	20	19
57171	20	19
57172	20	19
57173	20	19
57174	20	19
58486	20	14
58488	20	14
58490	20	15
58492	20	15
58493	20	14
58494	20	14
58496	20	15
58497	20	15
58501	20	14
58502	20	14
58504	20	15
58505	20	15
58508	20	14
58509	20	14
58511	20	15
58512	20	15
58515	20	14
58516	20	14
58518	20	15
58519	20	15
58522	20	14
58523	20	14
58525	20	15
58526	20	15
58528	10	14
58529	10	14
58530	10	15
58531	10	15

You want everything from a single source?

We provide you with complete solutions for sliding doors, windows and doors – for timber, PVC and aluminium. Experience our versatile system offer, comprehensive service included. Discover more of this on our website www.maco.eu or contact your MACO representative.

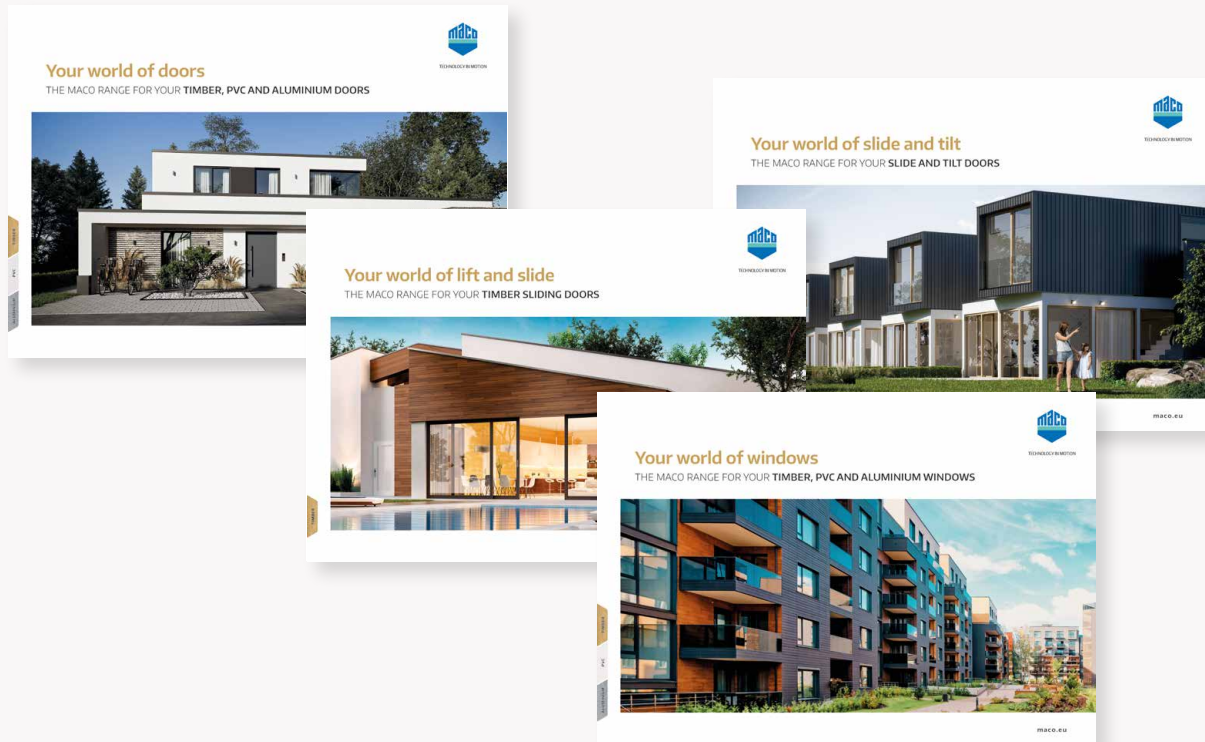

MACO near you:
www.maco.eu/contact



TECHNOLOGY IN MOTION



We regularly revise this document.
The latest version is available on <https://www.maco.eu/assets/759830>
or by scanning the QR code.

Created: 04/2023
Order no. 759830
All rights and amendments reserved.