

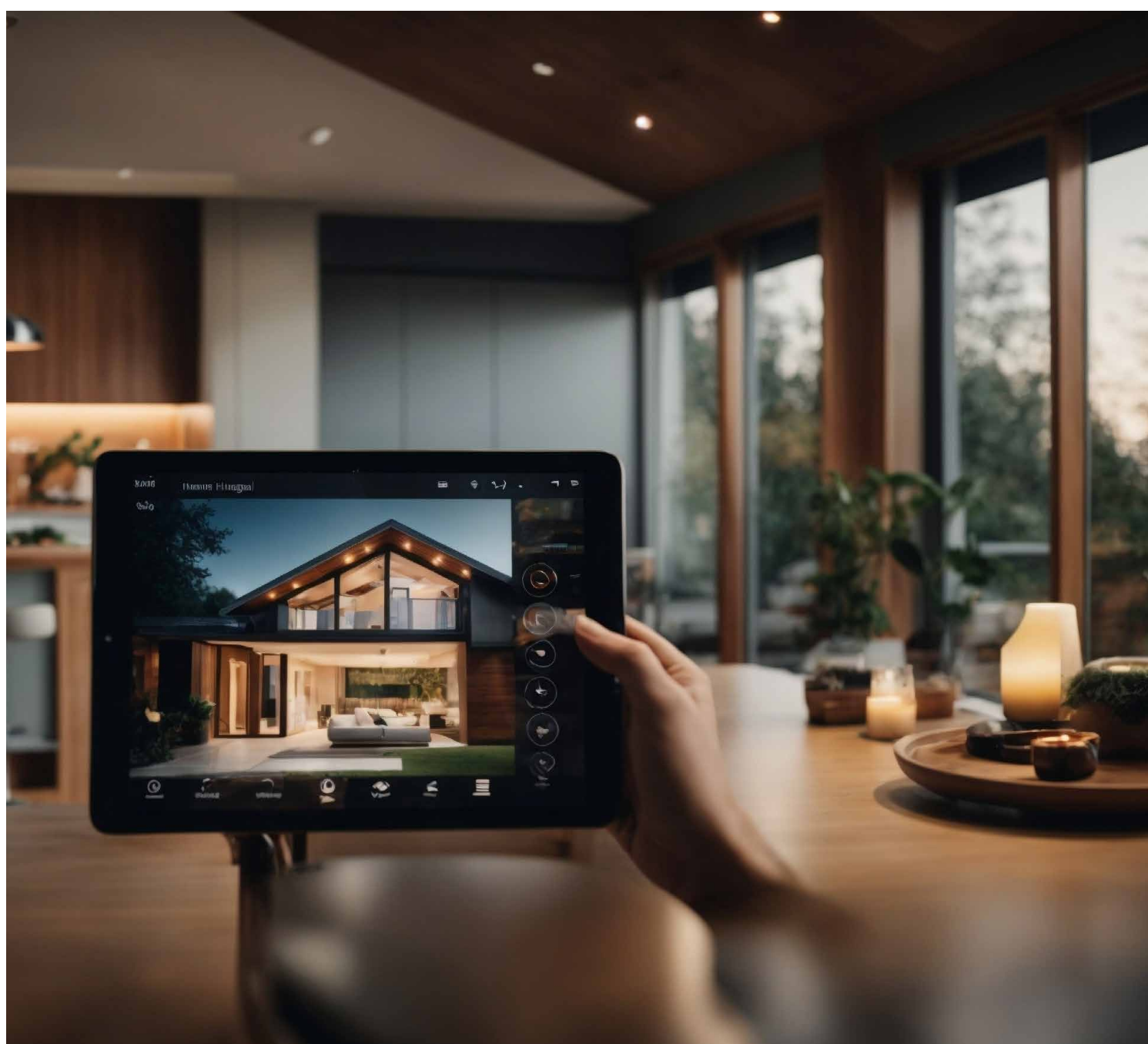

TECHNOLOGY IN MOTION

Solutions that combine design and security Selected systems at a glance



TIMBER
PVC
ALU

Window solutions

Discover what moves tomorrow's windows

For over 75 years, MACO has stood for technology in motion. Our hardware – the fittings in the frame and sash – makes it possible to open and/or tilt windows and casement doors. For windows that open to the outside or inside, and for windows made from aluminium, timber or PVC: any desired design can be implemented with our products and solutions. Our aim is to ensure that once installed, every opening, tilting and closing action is just as precise and reliable as the first time – for a lifetime.



MACO Multi Matic IQ

MACO Multi Matic has been our proven platform with solutions and system components for turn & tilt windows for more than a decade. We offer everything that supports, moves and adds functions to them. All elements build on each other and can be combined. We are continuously improving existing products with this in mind – and you can now identify these innovations by the “IQ” added to their name. **MACO Multi Matic (IQ)** – the complete system.

MACO Multi Matic i. S. cam IQ

The new MACO standard: our **MACO Multi Matic i. S. cam IQ** makes windows more secure and seals better than its predecessor – and all without any additional effort. With its intelligent self-adjustment, it guarantees the correct position at all times – without reworking. This means time saving during installation, maximum security and noticeably easier to use.



MACO Multi Matic IQ stands for security down to the last detail. With intelligent fitting parts such as the self-adjusting **i. S. cam IQ** and a proven system architecture, it offers permanently stable locking, high burglary protection and reliable functionality – for precision in craftsmanship and confidence for the consumer.



© AdobeStock, sbavun



MACO Multi Matic scissor stay IQ

NEW

The window scissor stay enables the tilt & turn position of windows. The new **MACO Multi Matic scissor stay IQ** has more compact dimensions, delivers extended service life and impresses with an improved anti-slam device – this prevents the tilted window from slamming shut unintentionally, in the event of a draught, for example.



MACO Multi Matic i. S. striker plate IQ

NEW

The **MACO Multi Matic i. S. striker plate IQ** has an optimised geometry that reliably returns the window sash to its position when closing. Tolerances are compensated for, ensuring smooth and precise closing at all times. The combination of steel and ZAMAK materials ensures ease of use and durability. The new **i. S. striker plate IQ** can also be installed on design elements with manufactured groove locators without additional effort – significantly reducing installation time. As a 'ready to recycle' solution, it also supports sustainable production processes.



MACO Multi Power

Our concealed hinge – that's **MACO Multi Power**. It uses premium hardware mechanisms to support and move windows and is completely hidden when the window is closed. A reliable solution that pays off – visually and technically elegant and effective, which ultimately enhances any room. That's **MACO Multi Power** – the designer solution.

MACO Multi Power 180°

NEW

MACO Multi Power 180° extends the concealed side of the hinge for maximum opening freedom: The window sash can be opened up to 180° and completely disappears from view. This creates more space, makes cleaning and use easier, and opens up new architectural possibilities – while maintaining an elegant appearance with no visible fitting parts.

At the same time, the continuous sealing and insulation layer remains completely intact, which has a positive effect on energy efficiency, soundproofing, and airtightness. With a capacity of up to 130 kg, **MACO Multi Power 180°** combines high stability with sophisticated design, making concealed fitting technology a real added value for modern window solutions.

MACO Multi Mammut

Large windows mean more light but also heavier weight. **MACO Multi Mammut** has the load capacity and makes it possible: The heavy-duty hardware effortlessly moves one- or two-sash windows and casement doors weighing up to 220 kg and with surfaces of up to 3.6 m². And it also offers burglary protection as well as efficient sound and energy insulation. **MACO Multi Mammut**, the reliable solution.

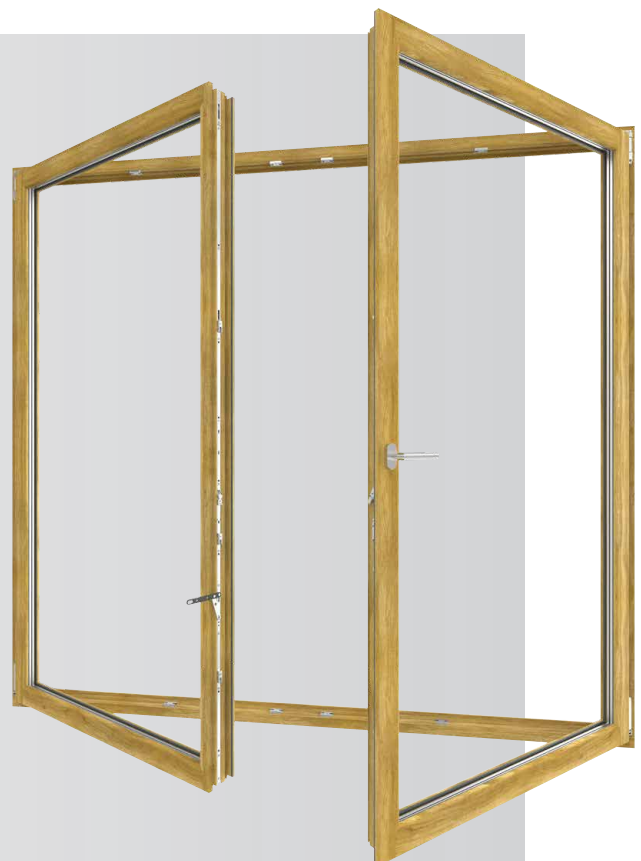

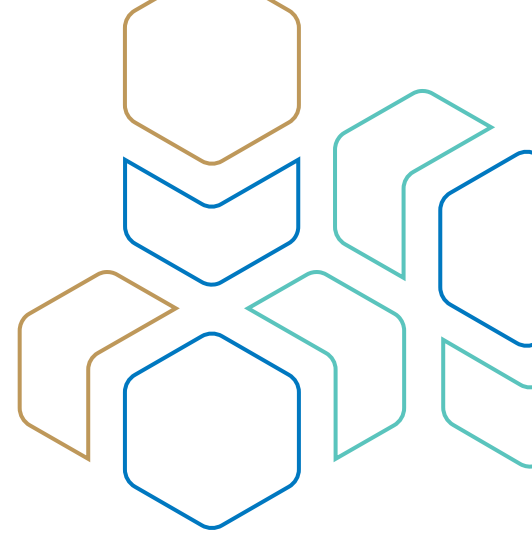

MACO Espags MKV

With **MACO Espags MKV**, we offer a system of locking solutions for windows that open to the outside with a special locking mechanism. Our MKV espagnolettes combine outstanding quality with ease of use and security. The V in MKV stands for the 5th generation of espagnolettes, with which we have been setting the standard for decades.

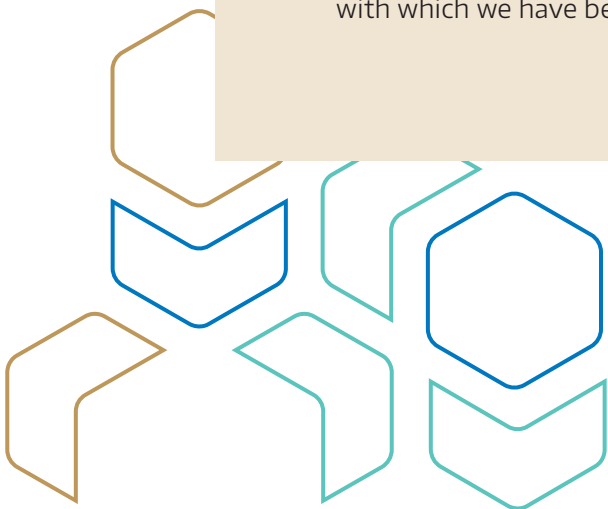

Sliding solutions

Experience systems that create more space

For over 75 years, MACO has stood for technology in motion. Our hardware – the fittings in the frame and sashes – makes it possible to lift, slide and tilt floor-to-ceiling and large-format window and door units. For aluminium, timber or uPVC doors. For lift & slide, slide & tilt or parallel sliding mechanism. For manual or motorised operation. Our hardware offers a high level of ease of use and reliability. And it does this in combination with efficient installation and durable, exceptionally low-maintenance quality.



MACO Move HS

Lift, slide and open as far as you like: This is the freedom that **MACO Move HS** hardware offers. A system in which the gears, rollers, gasket tracks and thresholds coordinate perfectly. For large lift & slide doors weighing up to 500 kg, providing more light and space. And with built-in brakes that ensure maximum ease of use, even if more force is applied than necessary.

MACO Move HS rollers

Quiet, smooth-running and durable: **MACO Move HS rollers** were developed for effortless lifting and sliding of heavy sliding doors. The large roller moves up to 500 kg, the smaller version up to 420 kg – while its lower height allows for narrower frame profiles. Both products are therefore among the highest capacity products on the market.



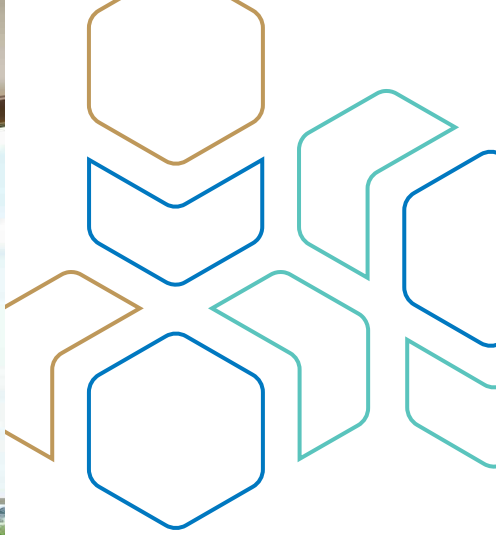

© MACO



MACO Move HS drive gears

NEW

With the **MACO Move HS drive gear portfolio** we now offer all key lift & slide components from a single source. The system concept is consistently reflected in the uniform design, smooth operation and proven MACO quality. All fitting parts are precisely coordinated with each other – for long-lasting functionality, high reliability and maximum security in planning and application.

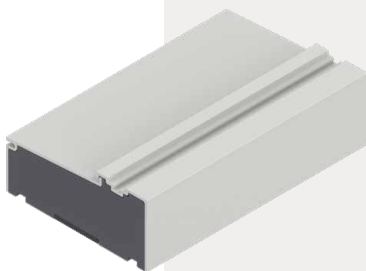

MACO Transit HS thresholds

NEW

The **MACO Transit HS threshold** impresses with its sustainable, foamed plastic core and offers maximum stability thanks to integrated reinforcement. The flexible modular system allows any design to be realised and ensures standard-compliant, secure installation. As screws no longer need to be sealed, installation is significantly easier – for fast, clean and long-lasting results.



MACO Move SK

For the best indoor climate and reliable burglary protection: That's what **MACO Move SK** is for. Floor-to-ceiling casement doors weighing up to 200 kg can be implemented with the slide & tilt system. Whether made of uPVC, timber, timber-aluminium or aluminium. And with the certainty that the room is well ventilated and burglary protection is enhanced even when in the tilted position. That's security for greater ease of use.

MACO Move SK Upgrade

MACO Move SK Upgrade makes floor-to-ceiling sliding doors weighing up to 200 kg significantly quieter and more stable. The intuitive operating logic prevents operating errors and reduces complaints. Retrofittable dampers, tilt brakes and frame dampers enable smooth tilt opening, quiet closing and synchronous closing movement – for noticeably more comfort in everyday use.

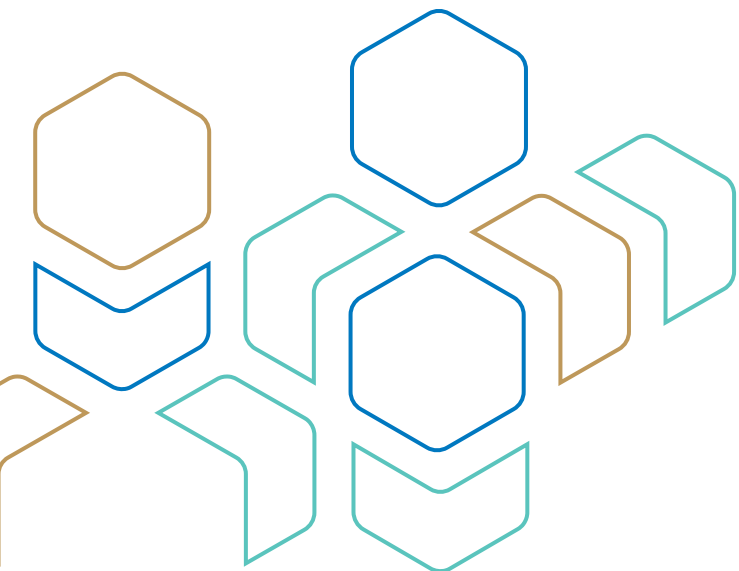

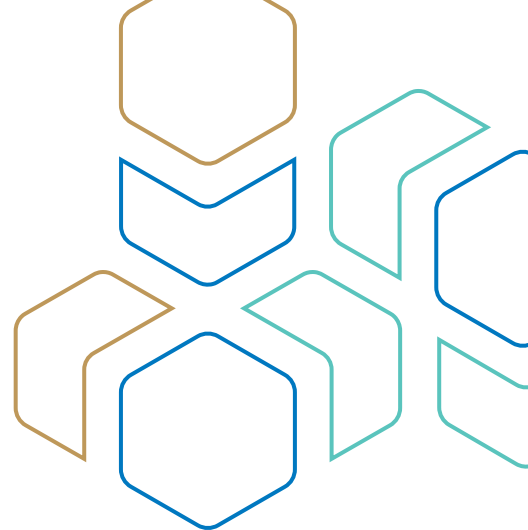

MACO Move PS

Little space required, intuitive operation, absolute air- and watertightness: **MACO Move PS** hardware enables implementation of sliding door solutions in aluminium or uPVC with a sash weight of up to 250 kg. The space-saving parallel position of the sash makes it possible to ventilate even when the window sill is closed – with minimum effort and maximum operating safety.

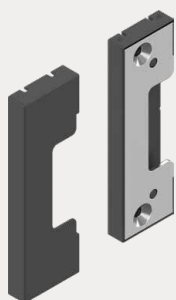

MACO Move PS hybrid striker plates

NEW

Fits securely, is secure: **the new hybrid striker plates** impress with their modern, streamlined design – complemented by accessories such as matching cover caps. The strikers are suitable for all standard PVC profiles. This makes production flexible and efficient. Equipped in this way, windows with burglary protection up to class RC 2 can be realised.

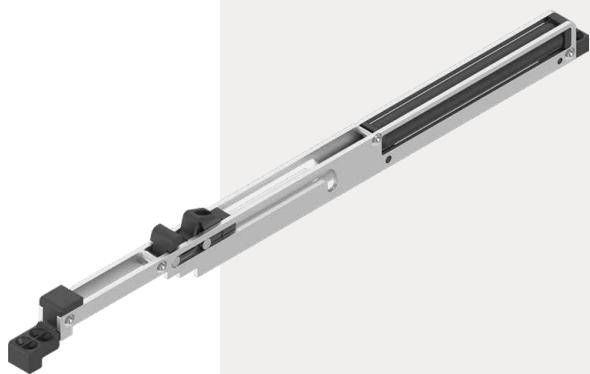

MACO Move PS damper

NEW

The **MACO Move PS damper** ensures noticeably quieter and gentler closing of parallel sliding elements – even with heavy sash weights. The assisted closing movement makes operation easier and prevents forceful braking. This reduces stress on the fittings and frame, which increases the service life of the entire element. For greater convenience, less wear and tear, and convenient everyday use.

Door solutions

Discover how solutions combine design and security

For over 75 years, MACO has stood for technology in motion. This also applies to our door solutions, which combine convenience with security day after day. Whether motorised, automatic, handle or cylinder-operated: MACO door solutions offer great design freedom and are characterised by efficient installation that impress fabricators, architects, consumers and juries – for example the German Innovation Awards for the first 3-latch motorised lock on the market.

MACO Protect French Casement drive gear

NEW

3-piece design for greater flexibility: The **MACO Protect French Casement drive gear** impresses with a high-quality lever mechanism. This makes 2-sash entrance doors easy to operate – whether they are made of timber, PVC or aluminium. It can also be adapted to different element sizes, is quick to install and can even be combined with motorised locks. The **new MACO Protect French Casement drive gear** is compatible with the following door locks: **MACO Protect M-TS, A-TS, Z-TF, Z-TS, G-TS and C-TS.**

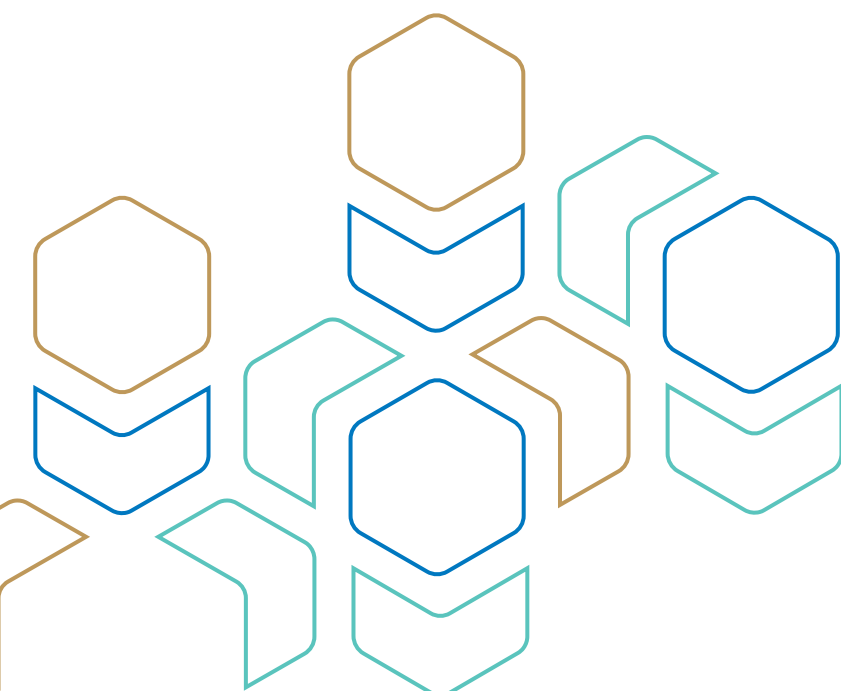
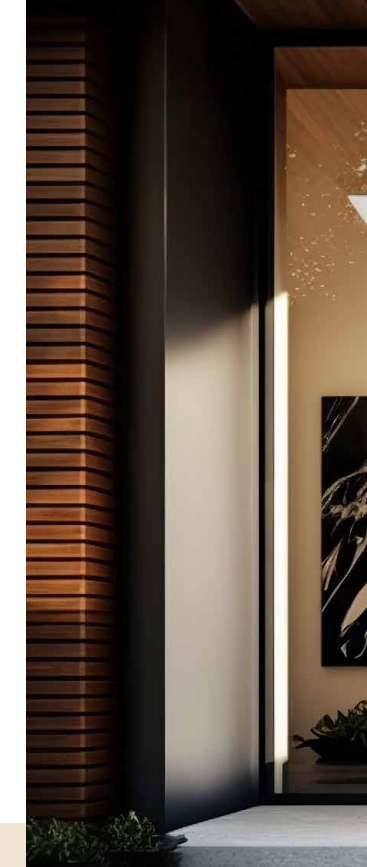



© AdobeStock, Csaba

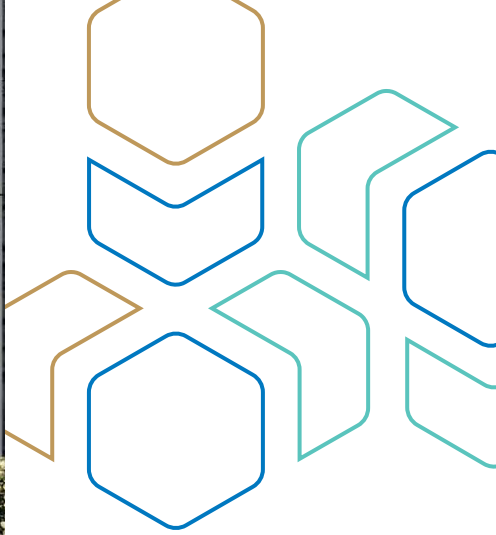

MACO Protect M-TS

From closed to open in 0.3 seconds: The **MACO Protect M-TS door lock** unlocks faster than any other lock on the market. When closing, MACO's proven 3-latch technology generates perfect mechanical contact pressure, and the locking is motorised. This ensures a high level of burglary protection, prevents door warping and improves thermal and sound insulation. The integrated status monitoring can be easily connected to alarm systems and smart home systems.



MACO Protect A-TS

Without a key: The **MACO Protect A-TS door lock** locks automatically after closing. This means that manual locking is only necessary as a child safety lock from the inside. The 3-latch technology ensures perfect contact pressure and reliably prevents the door from warping. This also creates the optimum seal that keeps out rain, wind and cold – and keeps energy and heat inside.

› Certified design according to EN 179/1125

NEW

The **MACO Protect A-TS door lock** is now also available in an EN 179/1125 certified design. Suitable for 1-sash emergency exit and panic doors with the E changeover function, the lock can be easily unlocked at any time in an emergency using a lever handle or panic bar. A motor can be easily retrofitted at any time for convenient access.

› Optimised motor

NEW

The new, optimised motor impresses with a significantly shorter unlocking time and improved acoustics – for noticeably more convenient access. In combination with the **MACO Protect A-TS door lock**, it really comes into its own: automatic locking is even faster, quieter and more efficient. The motor can be easily retrofitted at any time.

› Locking damper

NEW

Quieter than ever before: the new locking damper reduces the noise of the automatic locking system to a minimum – with full functional reliability. The innovative oil pressure damper therefore significantly increases ease of use. The solution can be easily retrofitted at any time, is optionally available with integrated day release and is compatible with **MACO Protect A-TS and M-TS door locks**.



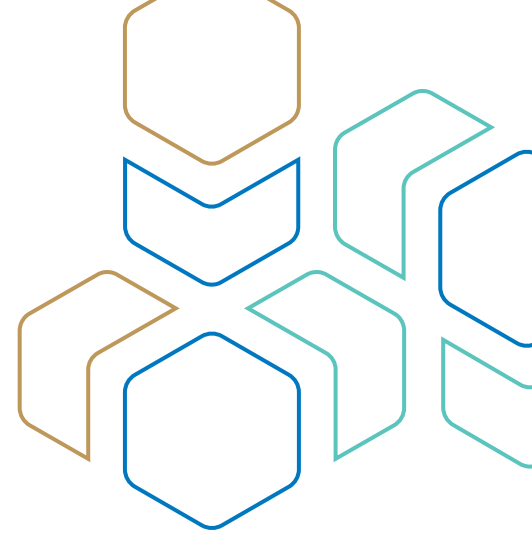

MACO Protect handle-operated

Locking without the use of a key: **MACO Protect handle-operated door locks**. For door heights of up to 3,100 mm and with greater flexibility in the use of locking elements. Whether hooks, bolts or security bolts, all variants are possible – also in combination. The term “handle-operated” is derived from the operating mode: the door is locked by operating the handle upwards and turning the key.

› **MACO Protect S-AF** **NEW**

With the new **MACO Protect S-AF** door lock MACO offers a solution specially developed for the French market. When closing, the door locks automatically and all locking elements extend fully – without the need to operate the handle. The door can still be opened conveniently using the handle, both from the inside and the outside, until it is deliberately locked with a key. For greater security and ease of use in everyday life.



MACO Protect cylinder-operated

Standard that sets benchmarks: **MACO Protect cylinder-operated door locks** are among the smoothest-running and most secure door locks on the market. Completely customised solutions can be implemented – for doors of up to 3,100 mm high and with bolts, hooks or security bolts for locking. The term “cylinder-operated” refers to the locking method: this is achieved by inserting and turning the key in the cylinder.

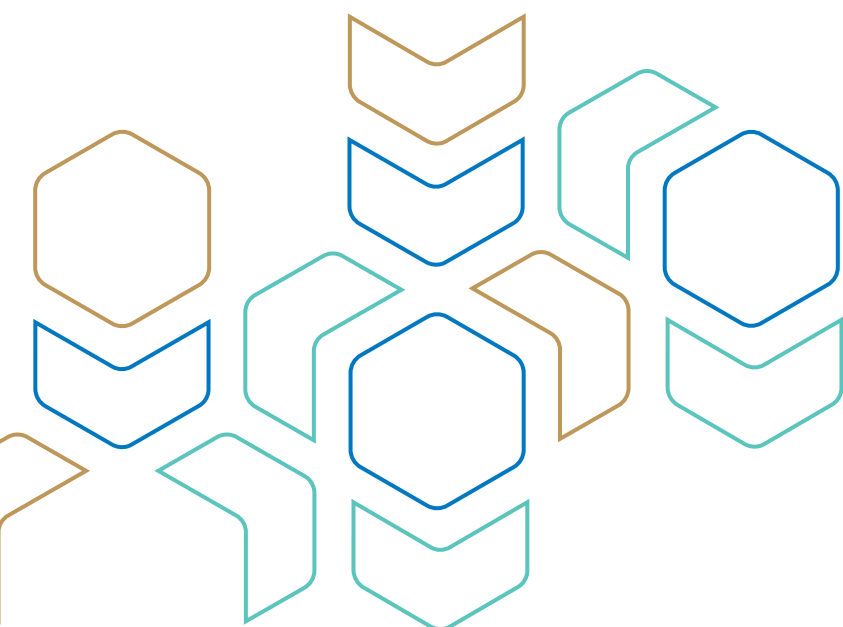



Instinct by MACO

Door lock reinvented: **Instinct by MACO** is the motorised and key-free solution for premium entrance doors that combines high-quality design and reliable function with maximum ease of use and high security. This is made possible by the horse-head locking mechanism, which closes in the direction of door movement. It is motorised and offers great design freedom for fabricators, architects and end users.

› Emergency power supply via USB-C interface

NEW

First demonstrated as a concept at Frontale 2024, the new additional module ensures 100% fail-safe operation. An Instinct door can be powered at any time via a USB-C power bank – regardless of the charge level of the UPS module or the duration of the power failure. Emergency power supply is possible from inside and/or outside and ensures reliable operation in any situation.





Sensor solutions

Experience how new possibilities can be created from data

For over 75 years MACO has developed technology in motion. This also includes our sensor solutions, which reliably detect the status of windows, sliding doors and doors and transmit this information to smart home systems. Their data therefore provides the decisive database for the automated monitoring and control of smart home devices. MACO offers sensor solutions that work with the EnOcean and the new, manufacturer-independent Matter standard.

Sense by MACO

Invisible, easy to install, future-proof: **Sense by MACO wireless sensors** make windows and doors intelligent in a flash, and detect whether they are open or closed. The sensors work with the new, cross-industry Matter standard for smart home solutions. This means maximum manufacturer independence and more convenience – because combined with other smart home products, security can be increased, energy consumption optimised and the indoor climate automatically controlled, therefore saving you money.

Sense by MACO | Window T&T

The solution for smaller windows or windows that are difficult to access: The sensor can be flexibly installed at any cam position – for example on the handle side – and facilitates battery replacement thanks to its easy accessibility. The sensor is mounted using adhesive tape, making it perfect for retrofitting.

Sense by MACO | Window Pro T&T

Ideal for the initial equipping of windows and French doors in combination with the MACO Multi Matic (IQ) fitting: The sensor is positioned as the last fitting component, making installation quick and easy. Thanks to its compact, fitting groove-integrated design, **Sense by MACO | Window Pro T&T** can be used in all standard profile geometries.



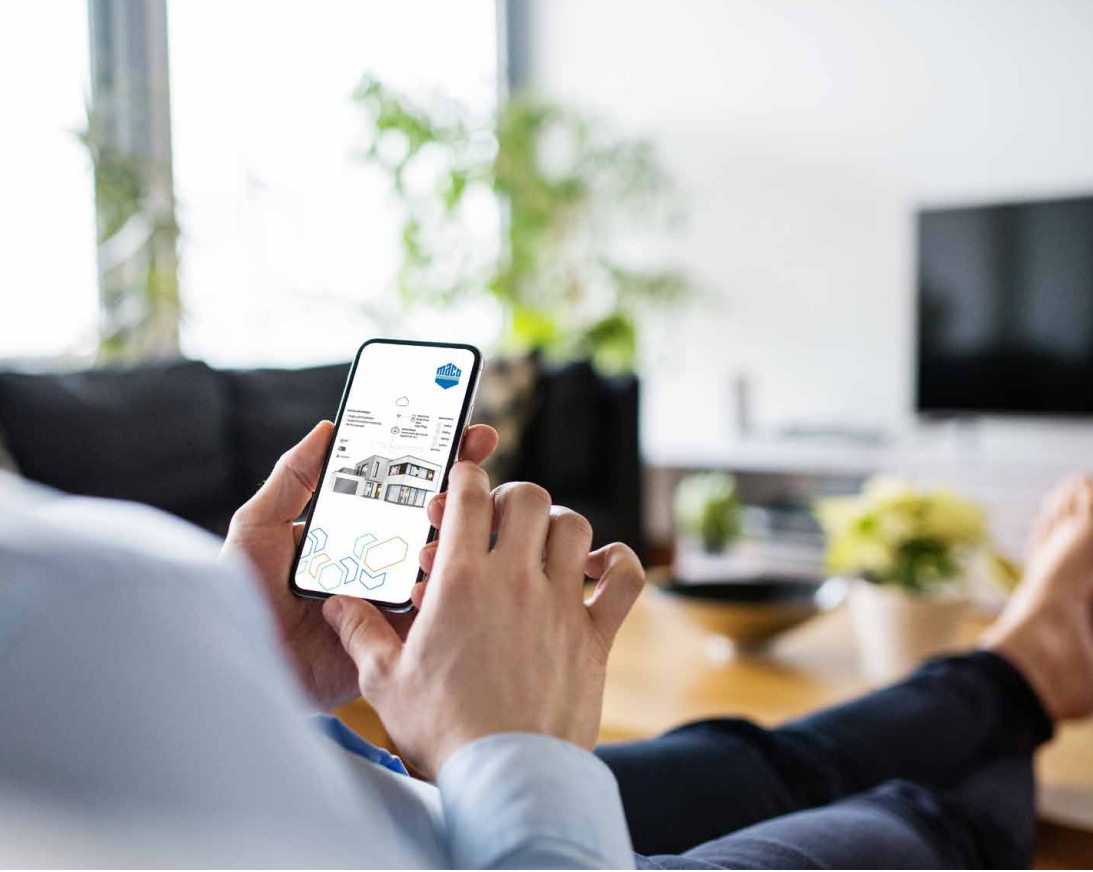

© AdobeStock, Halfpoint



Sense by MACO | Casement

The ideal sensor for outward-opening windows with MACO Espags fittings. It is installed on the frame side and can be flexibly adapted to a wide variety of window profiles using the enclosed adapter pieces. This makes it easy to install for manufacturers in the initial fitting phase, but also easy to retrofit.



Sense by MACO | Door

Especially for doors: The sensor enables full status monitoring for cylinder-operated, mechanical-automatic or fully motorised locks. With handle-operated locks, it reliably recognises whether the central locking bolt has been thrown.



Sense by MACO | Universal

Outstandingly versatile and can be retrofitted: the sensor for occasions where other solutions cannot be used. As the first wireless sensor on the market, it enables reliable, concealed closure monitoring of lift & slide doors, for example – but also opening monitoring of other building elements independent of the fittings.

Our sensor solutions create new possibilities from data

Future-proof with Matter

Secure and user-friendly: Matter is the new smart home standard that enables seamless communication between devices from a wide range of manufacturers.



Solution benefits

- › Easier, quicker installation
- › Status monitoring
- › Battery-operated



sense[®]
by MACO

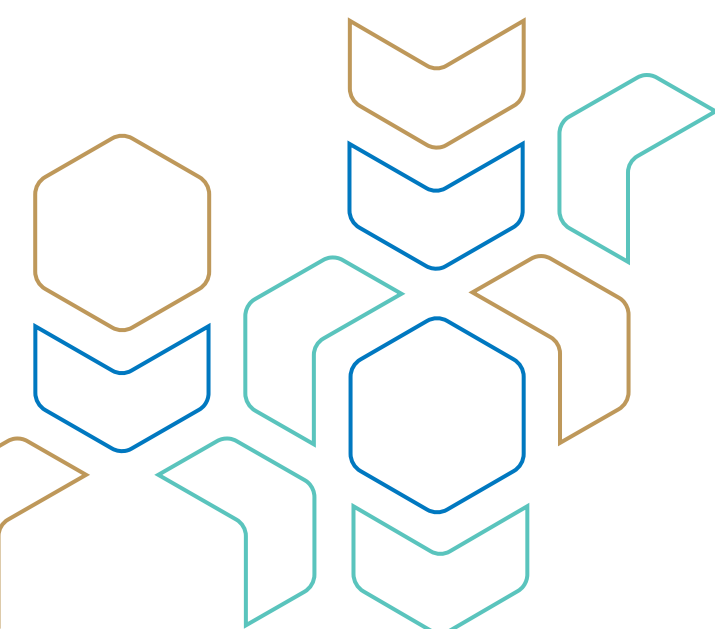

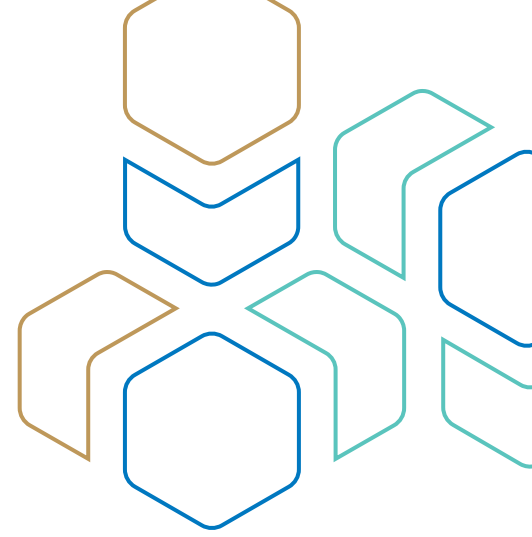

Apple Home
Google Home
Alexa
Smart Things
Ikea Home Smart

Really clever

All window, door and sliding door drives can be easily integrated into Matter-enabled smart home systems, enabling a wide range of automation scenarios.



Border Router

Connection to LAN or Wi-Fi
(e.g. Apple TV 4K)



Smart control

-  Heating
-  Shading
-  Lighting
-  Sockets

and more ...

Service solutions

Receive support for your processes that will help you move forward

For 75 years, MACO has stood for technology in motion. But it is also our service solutions that make us a valuable and favoured partner. From the design, planning and test phase to production and sales: With the MACO service solutions Digital Service, Norm Service and Product Service, we support fabricators in a practice-based way so that you can arrange your processes to be faster, more reliable and therefore more efficient.

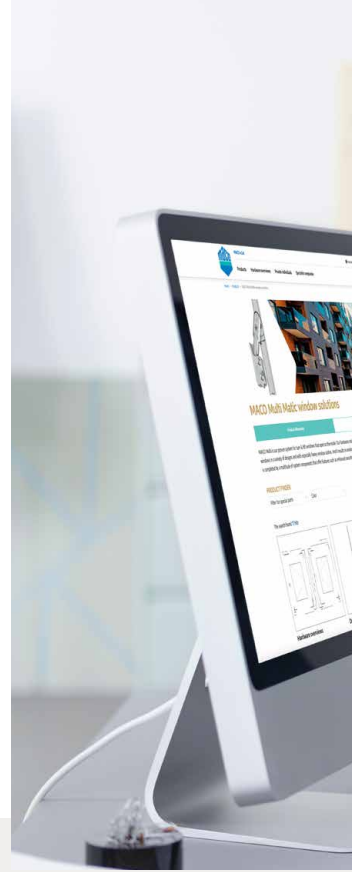

Digital Service

Digitising processes and making them more efficient: With **MACO Digital Service** we achieve this in several ways. New and convenient: **eCat** is the digital reference guide to all MACO products – the Pro version includes lots of additional information and a download function. With **MACO Win**, the configuration of fittings is quick and easy, while the **Data** and **BIM** service offerings provide customised and detailed data for planning and production. Our **Shop** and **EDI** service solutions automate the purchasing process and reduce manual processes.



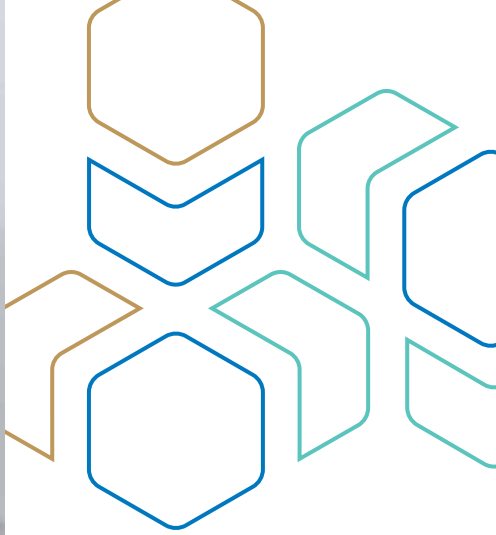
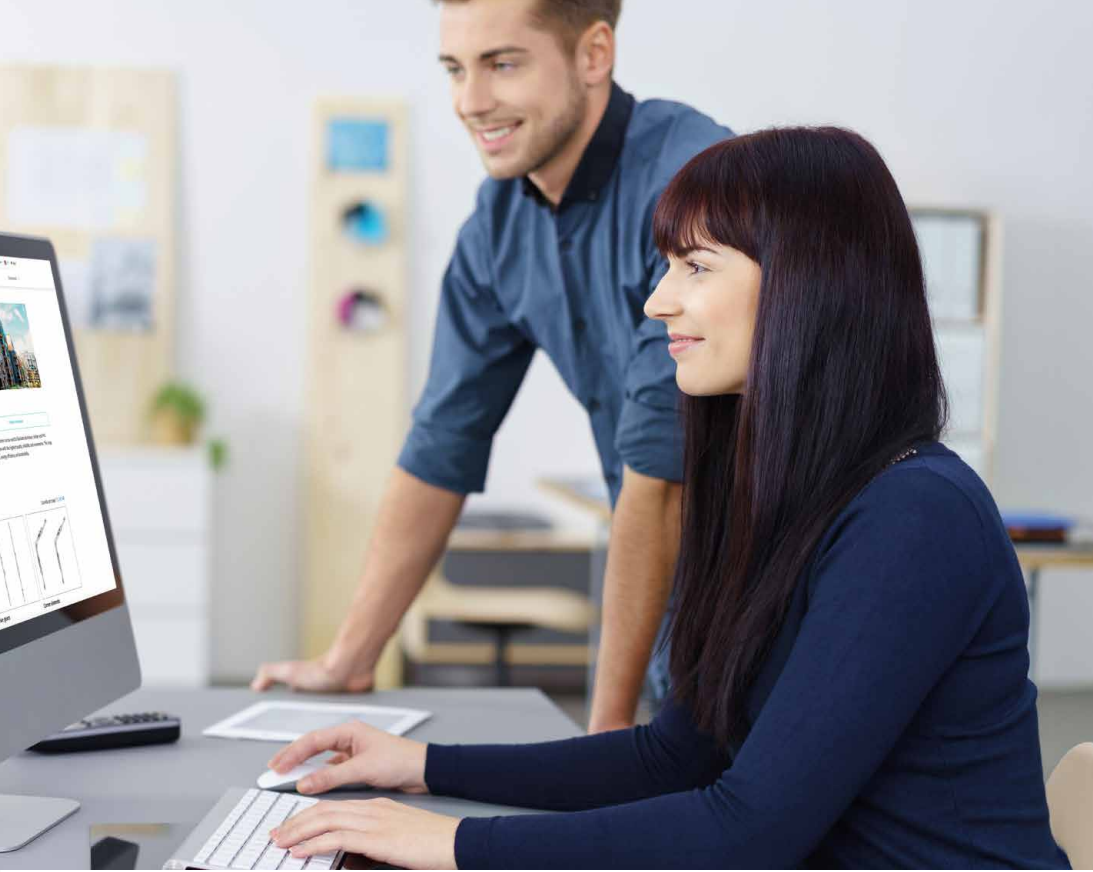

© AdobeStock, contrastwerkstatt

eCat **NEW**

The **new eCat** replaces the previous TOM and is the digital reference guide to the entire MACO product range. Freely accessible in the Light version or with many extras such as technical drawings, application information, 6-page views and drilling and milling diagrams, also available for download in the Pro version upon registration in the MACO Partner Portal.

Norm Service

Advice, expert knowledge, licences and reliable tests: for standard-compliant production, MACO offers many solutions when it comes to burglary protection **RC** and **CE** conformity **CE**. With **TBDK** MACO even determines the maximum permissible sash weights. This results in products that meet the requirements of both legislators and our customers.

Product Service

All the best for production: While **MACO Product Service** increases efficiency with prefabricated lift & slide systems and customised thresholds (**Pre-Assembly**), the wide selection of gauges, tools and machines (**Assembly Tools**) makes installation easier.

Window automation

Discover the system for greater security

Modern window automation enables efficient, natural ventilation – customised to window size, opening type and the desired air exchange. In the event of a fire, the SHEV technology provides rapid alarm activation and reliable smoke and heat extraction. All drives can also be easily integrated into smart building control systems using the new Matter technology.



HAUTAU SBS Comfort Drive



The **HAUTAU SBS Comfort Drive scissor fitting** can be directly coupled with locking drives that use Comfort Drive technology thanks to integrated bus technology – without any external devices. It fulfils SHEV requirements and, in combination with the central locking system, also RC requirements and is tested in accordance with EN 12101-2. Opening times of less than 60 seconds ensure a fast response and a high level of airtightness via the central locking system. The slimline design facilitates installation. The combination with the compact SHEV control panel RAZ K and the modular SHEV and ventilation control panel RZ2/LZ2 enables integrated solutions for smoke extraction and ventilation.

HAUTAU PRIMAT compact 300 Comfort Drive



The **HAUTAU PRIMAT compact 300** offers maximum flexibility for natural ventilation and smoke extraction, either as a 24 V or 230 V fanlight drive with a stroke of up to 300 mm. The slimline design enables use even in narrow profiles, and the very quiet operation is impressive even in sensitive areas. The optional connection to the central locking system increases security. The 2-scissor stay design ensures high contact pressure; as a tandem set, the drive is coupled directly via the internal bus. The stroke and speed can be set using the Config Tool and operated smartly via a Wi-Fi box.



© iStock, skymesher

HAUTAU SHEV Module Centre RZ2 NEW

The **HAUTAU RZ2 SHEV Module Centre** can also be used as a modular ventilation control unit and can be flexibly expanded using additional modules. It controls 24 V drives in windows, flaps and skylight domes and enables manual or automatic ventilation functions. With staggered current ranges up to 72 A, versatile connection options and adjustable additional functions – also via Config Tool – it supports the creation of one or more SHEV and ventilation groups and offers maximum flexibility for smoke extraction and building ventilation.





TECHNOLOGY IN MOTION

Information, solutions, advice MACO is here for you

Find out more about the MACO range of fittings at www.maco.eu and download additional documentation, installation instructions and certificates. You can also find the MACO customer consultant in your area by visiting our website. Contact us for personalised advice – we look forward to helping you.

MACO near you:
www.maco.eu/contact



This document is constantly being revised.
You can find the current version at <https://www.maco.eu/assets/760355>
or by scanning the QR code.

Created: 03/2026
Order no. 760355
All rights and amendments reserved