



VALORIZZIAMO  
IL SERRAMENTO

# MACO PROTECT

SERRATURE



















CATALOGO



MACO Protect Soluzioni per porte

<b>1</b>	<b>Informazioni tecniche e generali</b>	<b>5</b>
<hr/>		
<b>2</b>	<b>Serratura autobloccante (A-TS)</b>	<b>11</b>
<hr/>		
<b>3</b>	<b>Serratura motorizzata (M-TS)</b>	<b>25</b>
<hr/>		
<b>4</b>	<b>Serratura automatica comando cilindro (Z-TF)</b>	<b>35</b>
<hr/>		
<b>5</b>	<b>Serratura comando cilindro mod. (Z-TS)</b>	<b>43</b>
<hr/>		
<b>6</b>	<b>Serratura comando maniglia prolungabile (G-TS)</b>	<b>57</b>
<hr/>		
<b>7</b>	<b>Serratura per portafinestra (B-TV)</b>	<b>61</b>
<hr/>		
<b>8</b>	<b>Scontri</b>	<b>65</b>
<hr/>		
<b>9</b>	<b>Asta a leva</b>	<b>85</b>
<hr/>		
<b>10</b>	<b>Catenacci</b>	<b>93</b>
<hr/>		
<b>11</b>	<b>Accessori</b>	<b>97</b>
<hr/>		
<b>12</b>	<b>Indice articoli</b>	
<hr/>		

<b>Nº</b>	Codice articolo		Raggiatura estremità del catenaccio
	Confezione unitaria		Uscita puntale
€	Prezzo lordo in €(/00 significa che il prezzo si riferisce a 100 pezzi)	G-TS =	Serratura comando maniglia
	Interasse	Z-TS =	Serratura comando cilindro
	Entrata maniglia	Z-TF =	Serratura automatica comando cilindro
	Misura quadro	A-TS =	Serratura autobloccante
	Altezza maniglia (HM)	Z-RS =	Serratura Z-RS scrocco-mandata
	Altezza battente in battuta (HBB)	MF =	Scrocco multifunzione
	Frontale	ZS =	Serratura supplementare
<b>L</b>	Lunghezza	B-TV =	Serratura per portafinestra
	Quantità funghi	MM =	Multi-Matic
	Lunghezza catenaccio	U =	Frontale-U
	Larghezza puntale	PZ =	Cilindro
<b>B</b>	Larghezza	RZ =	cilindro tondo
<b>H</b>	Altezza	i.S. =	Fungo
	Misure scontro scrocco mandata ad angolo	VZ =	nottolino
	Profondità battuta (PB)	HO =	Gancio verso l'alto
	Altezza frontale davanti	BO =	Punzone
	Altezza frontale U	HO-BO =	Combinazione gancio - punzone
		MF-BO =	Combinazione scrocco - punzone
		MF-HO =	Combinazione scrocco - gancio
		SFG =	Asta a leva
		EV =	Terminale
		K+ =	Posizione scatola serratura al di sopra dell'altezza maniglia

**Nota:** Quando non indicato diversamente, le misure sono in mm ed il contenuto delle confezioni in numero di pezzi

## 1 Informazioni tecniche e generali

### 1.1 Norme sulla responsabilita' del produttore

#### Programma serrature MACO PROTECT

Osservare le informazioni di seguito riportate relative al sistema di serrature per porte MACO PROTECT. La mancata osservanza di tali indicazioni solleva il produttore da qualsiasi responsabilità civile nei confronti di terzi.

#### 1. Informazioni sul prodotto e uso corretto

Il sistema di serrature per porte comprende, per definizione, la ferramenta (su anta e telaio) necessaria per porte in legno, PVC, alluminio e relative combinazioni. Le serrature per porte hanno le seguenti funzioni di base:

- a) chiudere la porta (mantenere la porta chiusa mediante lo scrocco) e
- b) bloccare la porta (serrare la porta con la mandata).

Tutte le serrature per porte Maco sono caratterizzate da una chiusura multipunto e possono essere impiegate nei sistemi di chiusura per porte a montaggio verticale. La gamma di serrature per porte Maco propone due sistemi di serrature dal diverso funzionamento:

#### 1.1 Serratura comandata con maniglia

Il sistema comandato con maniglia consente di chiudere e serrare la porta mediante lo spostamento della maniglia verso l'alto che aziona la fuoriuscita dei punti di chiusura. Una volta chiusa la porta, la serratura viene bloccata mediante una rotazione di 360° della chiave. La maniglia non può più essere spostata verso il basso e i punti di chiusura sono bloccati. Invertendo la rotazione della chiave nel cilindro, il sistema comandato con maniglia viene nuovamente sbloccato e i punti di chiusura non sono più bloccati. Spingendo la maniglia verso il basso, i punti di chiusura e lo scrocco rientrano consentendo l'apertura della porta.

Importante: nella serratura comandata con maniglia devono essere montate sia la maniglia esterna che quella interna!

#### 1.2 Serratura comandata con cilindro

Il sistema comandato con cilindro consente di serrare la porta, dopo che è stata chiusa, mediante due rotazioni di 360° della chiave nel cilindro che fanno penetrare i punti di chiusura negli scontri bloccando la porta. Facendo compiere alla chiave due giri in senso inverso alla chiusura, il sistema viene sbloccato. Per aprire la porta lo scrocco può essere fatto rientrare sia muovendo la maniglia che ruotando la chiave nel cilindro. Nelle serrature comandate con cilindro è possibile montare un pomolo sul lato esterno della porta. Le serrature multipunto Maco possono essere montate in combinazione con i cilindri reperibili in commercio conformi alla norma DIN 18254. Le scatole della serratura sono conformi alla norma DIN 18251. In casi particolari chi installa una serratura Maco deve accertarsi che

il cilindro scelto sia adatto alla prevista serratura e possa garantire una buona funzionalità.

#### 2. Montaggio

Le serrature multipunto MACO possono essere montate solo da personale specializzato. Le serrature per porte MACO devono poter essere inserite senza difficoltà nelle fresate della cava ferramenta previste per il montaggio delle scatole serratura e delle chiusure con gancio e a scrocco/punzone. L'inserimento forzato dei componenti nelle fresate potrebbe pregiudicare la funzionalità dell'intera serratura. Per avvitare il frontale nella cava utilizzare solo utensili adatti (strumenti torsionometrici). Gli scontri (standard, antieffrazione, per chiusura a gancio e a punzone) devono essere montati in modo da consentire la chiusura dei punti di chiusura senza alcuna difficoltà e far sì che i punti di chiusura, una volta che sono completamente fuoriusciti, non penetrino nello scontro fino alla battuta. Per il corretto montaggio del prodotto ogni frontale e il rispettivo scontro sono dotati di tacche che facilitano l'esatto posizionamento dello scontro rispetto al frontale. Le serrature multipunto Maco possono essere montate in molti tipi di portoncini e porte secondarie tenendo presente che questi componenti non sono in grado di adattarsi a deformazioni o variazioni della chiusura della porta causate da sbalzi di temperatura o cambiamenti strutturali.

#### 3. Uso non conforme ed errato

I disegni sulle prossime pagine mostrano i casi di uso errato e uso non conforme.

#### 4. Manutenzione

Per garantire il perfetto funzionamento delle serrature multipunto MACO PROTECT,

- fornire a montatori ed illustratori le necessarie informazioni e istruzioni;
- osservare le normative vigenti in materia;
- utilizzare le serrature multipunto MACO rispettando le funzioni a cui sono preposte;
- osservare tassativamente le indicazioni del produttore relative alla composizione della ferramenta;
- seguire le istruzioni per la manutenzione e la cura;
- far eseguire interventi di riparazione solo da personale specializzato.

#### 5. Prestazioni

Per qualsiasi applicazione non riportata nei nostri cataloghi e prospetti, rivolgersi ai tecnici Maico.

I dati relativi alle prestazioni dei prodotti sono riferiti esclusivamente alla combinazione di componenti originali Maco.

La funzionalità dei sistemi di chiusura dipende dalla frequenza e dalle modalità di utilizzo, dalle condizioni ambientali e dalla manutenzione eseguita.

### 6. Sezioni

In base al tipo di lavorazione adottata si sceglie la serratura con le caratteristiche più appropriate.

Attenzione: Rispettare le quote indicate per lo scostamento della cava ferramenta al fine di garantire un ottimale funzionamento della serratura.

### 7. Prodotti commercializzati

Segnaliamo espressamente che il presente catalogo contiene anche articoli **non** fabbricati/prodotti da aziende del Gruppo

MACO. Questi prodotti sono contrassegnati da note a piè di pagina, sotto le tabelle dei prodotti del catalogo. Per questi prodotti si applicano tutte le specifiche tecniche, le note, le istruzioni e le linee guida dei rispettivi produttori, nonché esclusivamente i loro impegni di garanzia. Per questi prodotti le garanzie MACO sono espressamente escluse, a meno che non sia stato espressamente concordato diversamente per iscritto.

Elenco dei produttori delle rispettive linee di prodotti:

- Gretsch Unitas Italia Srl
- Siegenia - Aubi Srl
- Ekey Biometric Systems GmbH

### 1.2 Certificati e garanzie

MACO assicura l'alta qualità dei propri prodotti sia attraverso continui e ricorrenti test interni, sia con verifiche eseguite presso rinomati e indipendenti istituti esterni. Tutti gli attuali certificati degli istituti di prova, gli attestati di qualità, sicurezza e di sistema di gestione ambientale così come le nostre dichiarazi-

oni di garanzia sono disponibili sul nostro sito [www.maco.eu](http://www.maco.eu). Per tutti i prodotti MACO è anche disponibile, sempre sul sito, la dichiarazione di sicurezza riguardante le sostanze chimiche. (Dichiarazione REACH).

### 1.3 Condizioni generali di vendita

Una versione aggiornata delle condizioni generali di vendita è scaricabile dal nostro sito ([www.maico.com](http://www.maico.com)).

## 1.4 Soluzione innovativa - il frontale a "T"

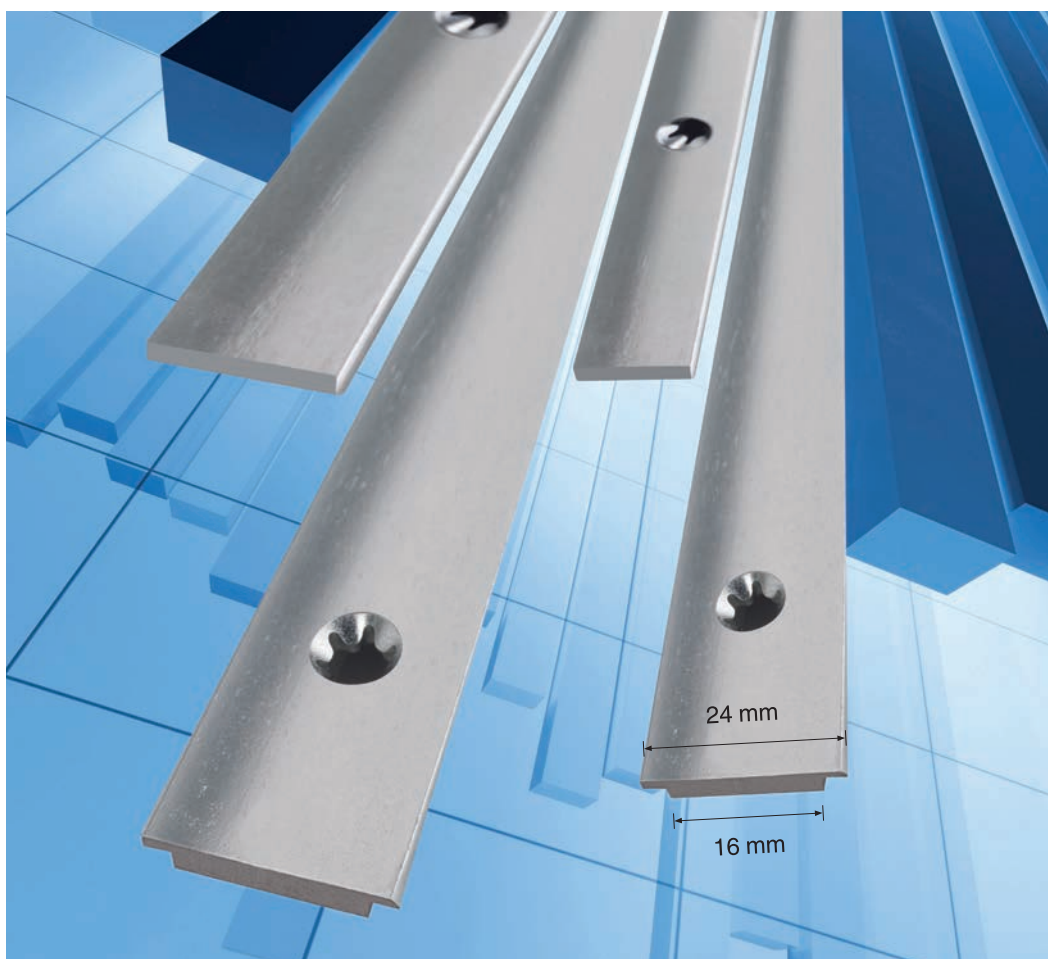

### L'evoluzione tecnica del frontale

#### Vantaggi

- La sicurezza e le caratteristiche estetiche del frontale piatto di 24 mm abbinata a una cava ferramenta da 16 mm
- Nessun deposito di sporco nell'intercapedine tra frontale e cava ferramenta
- La larghezza di 24 mm assicura la copertura delle eventuali imprecisioni dovute agli scassi per l'alloggiamento delle scatole
- Maggiore robustezza rispetto al frontale da 16 mm
- Semplicità di montaggio e posizione delle viti identica a quella dei frontali standard

### Vantaggi del frontale a T

Nessun deposito di sporco nell'intercapedine tra frontale e cava ferramenta

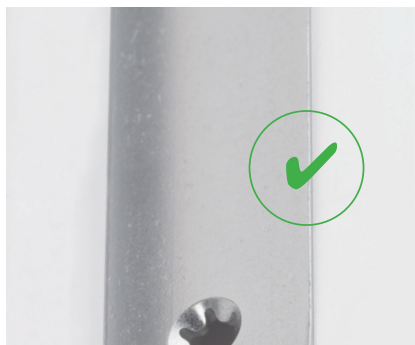

La larghezza di 24 mm assicura la copertura delle eventuali imprecisioni dovute agli scassi per l'alloggiamento delle scatole

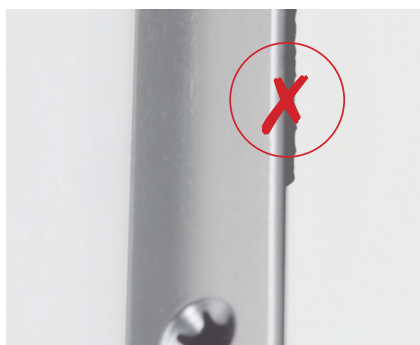

Nessuna riduzione dell'aria

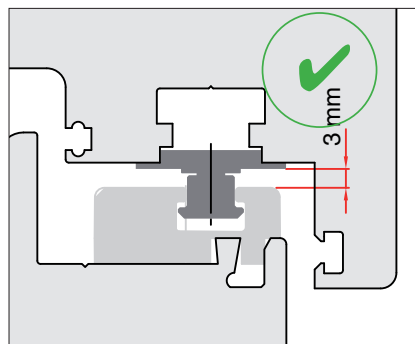
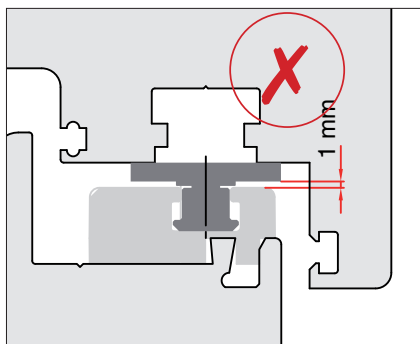

**1.5 Sezioni di profilo**

**Profili in legno**

**Aria 4 mm**

Frontale 16 mm

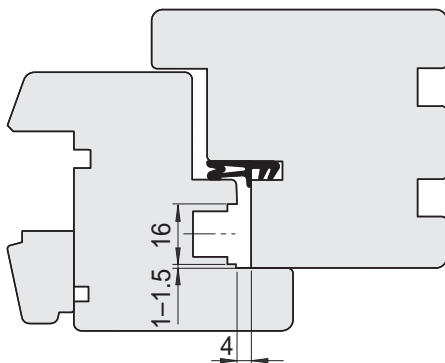

**Aria 12 mm**

Frontale 16 mm

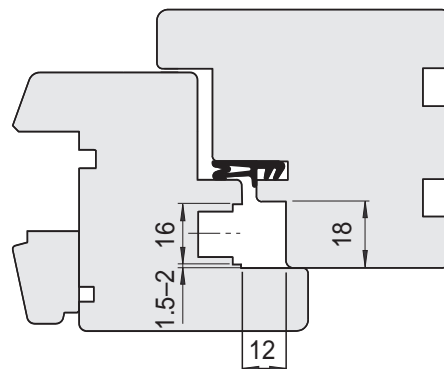

**Aria 4 mm**

Frontale 20 mm

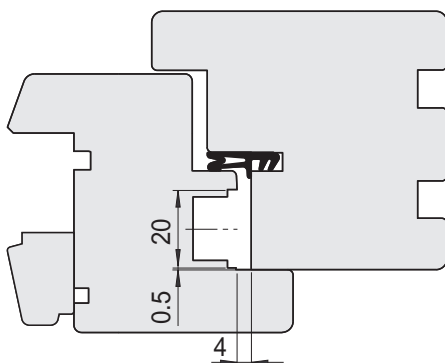

**Aria 12 mm canalino Euro**

Frontale 16 mm

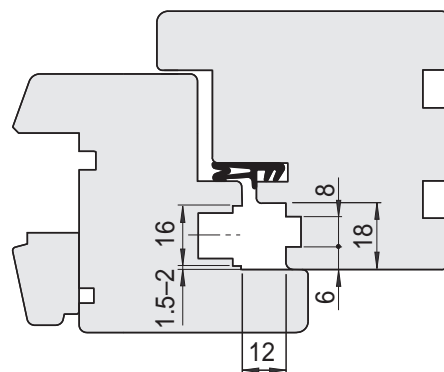

**Profili in PVC**

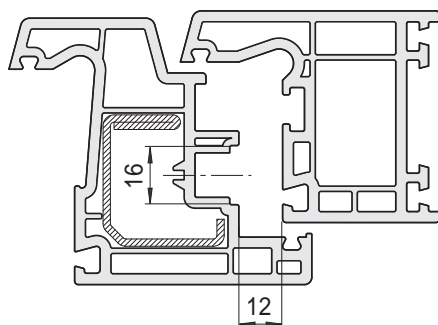

**Profili in alluminio**

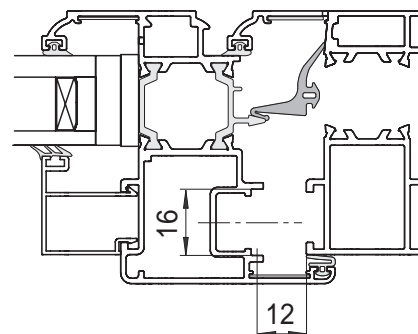



## **2 Serratura autobloccante (A-TS)**

---

<b>2.1</b>	<b>Composizione ferramenta serratura autobloccante</b>	<b>12</b>
<b>2.2</b>	<b>Serratura autobloccante con 2 scrochi - 2 ganci</b>	<b>17</b>
<b>2.3</b>	<b>Accessori per serratura autobloccante A-TS</b>	<b>21</b>

## 2 Serratura autobloccante (A-TS)

### 2.1 Composizione ferramenta serratura autobloccante

- ① Prolunga

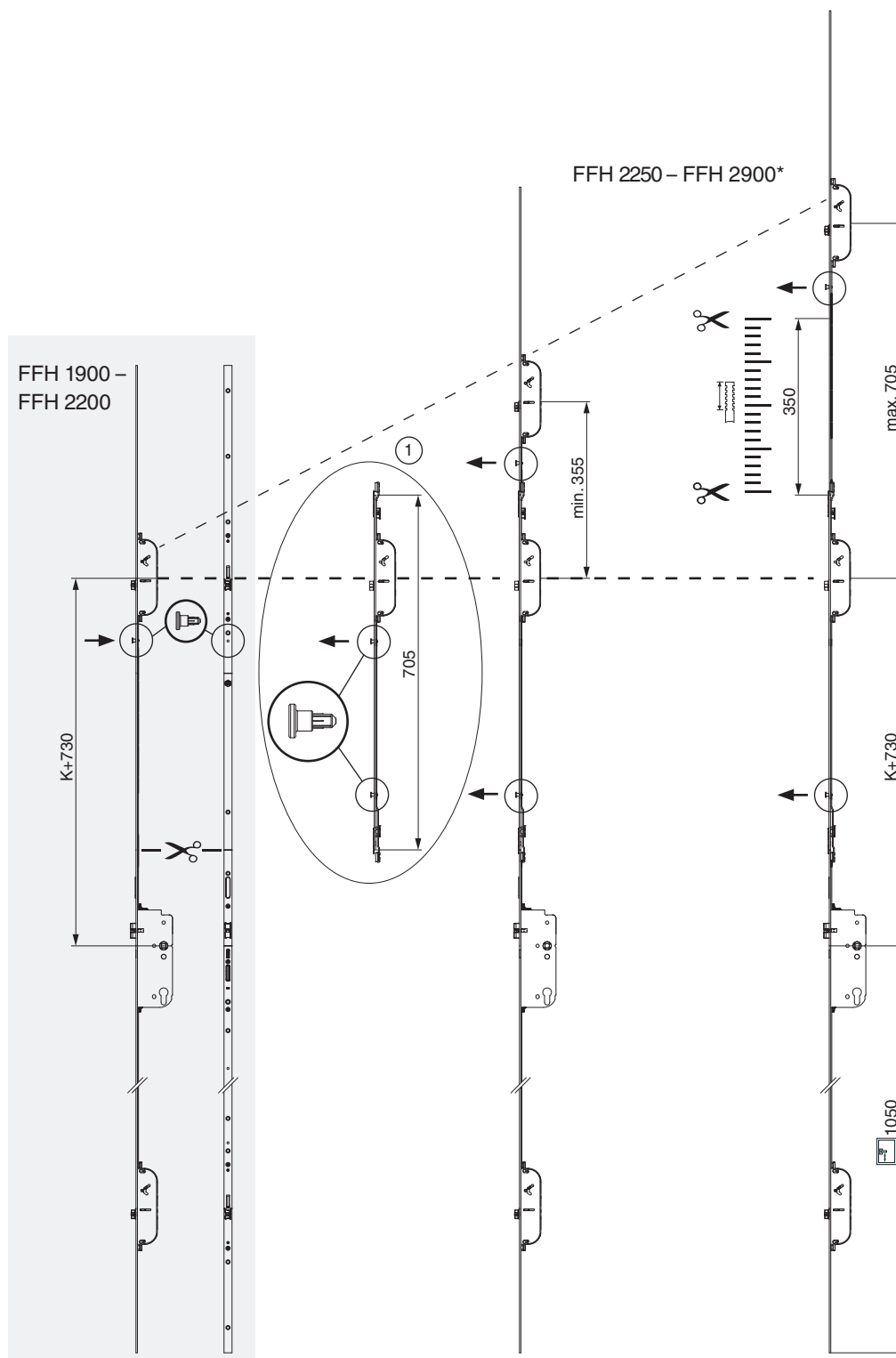

\* con frontale di copertura fino a HBB 3100mm!

- ① Giunzione accorciamento serratura
- ② Prolunga per serratura

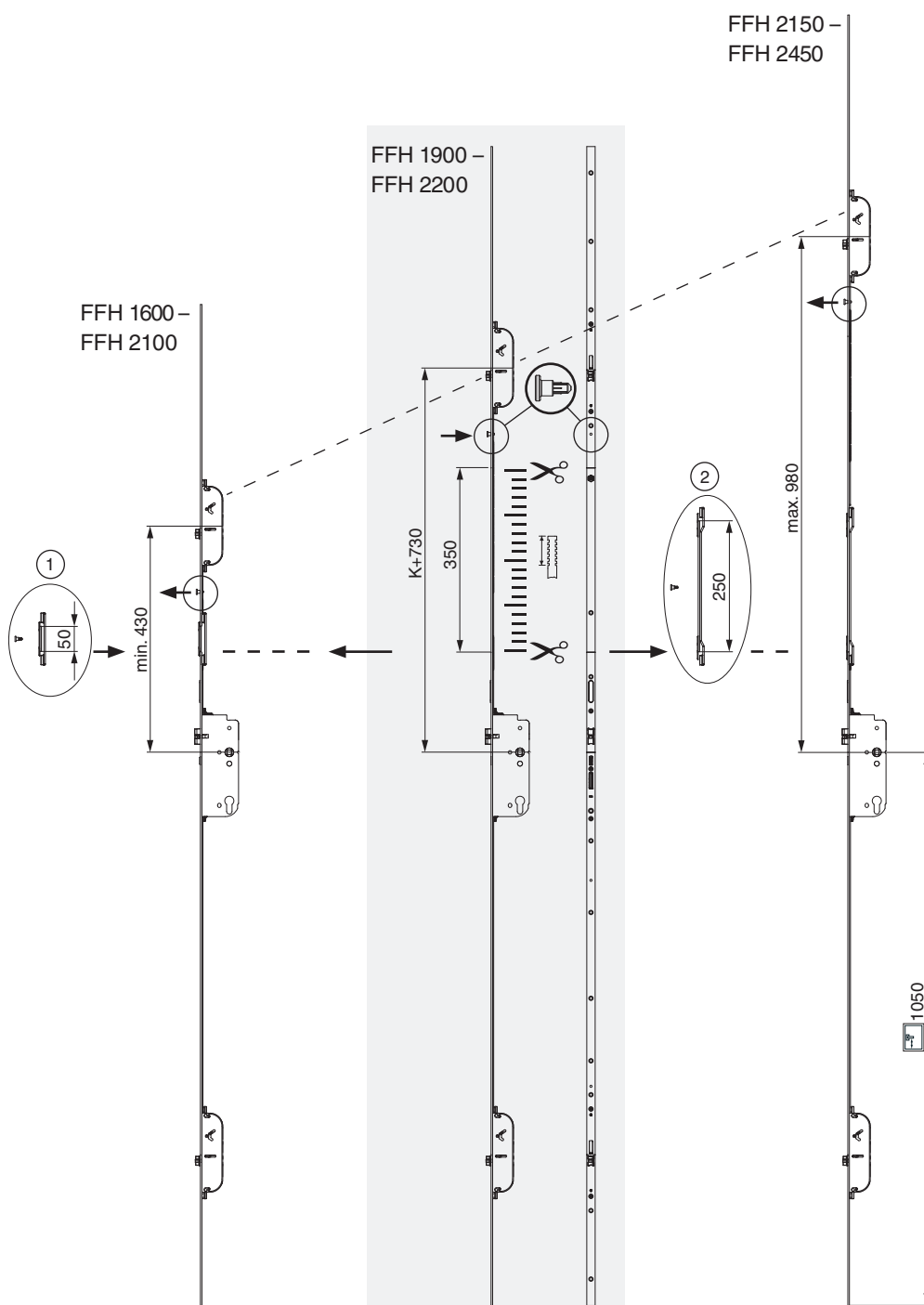





2 scrochi - ganci K+605

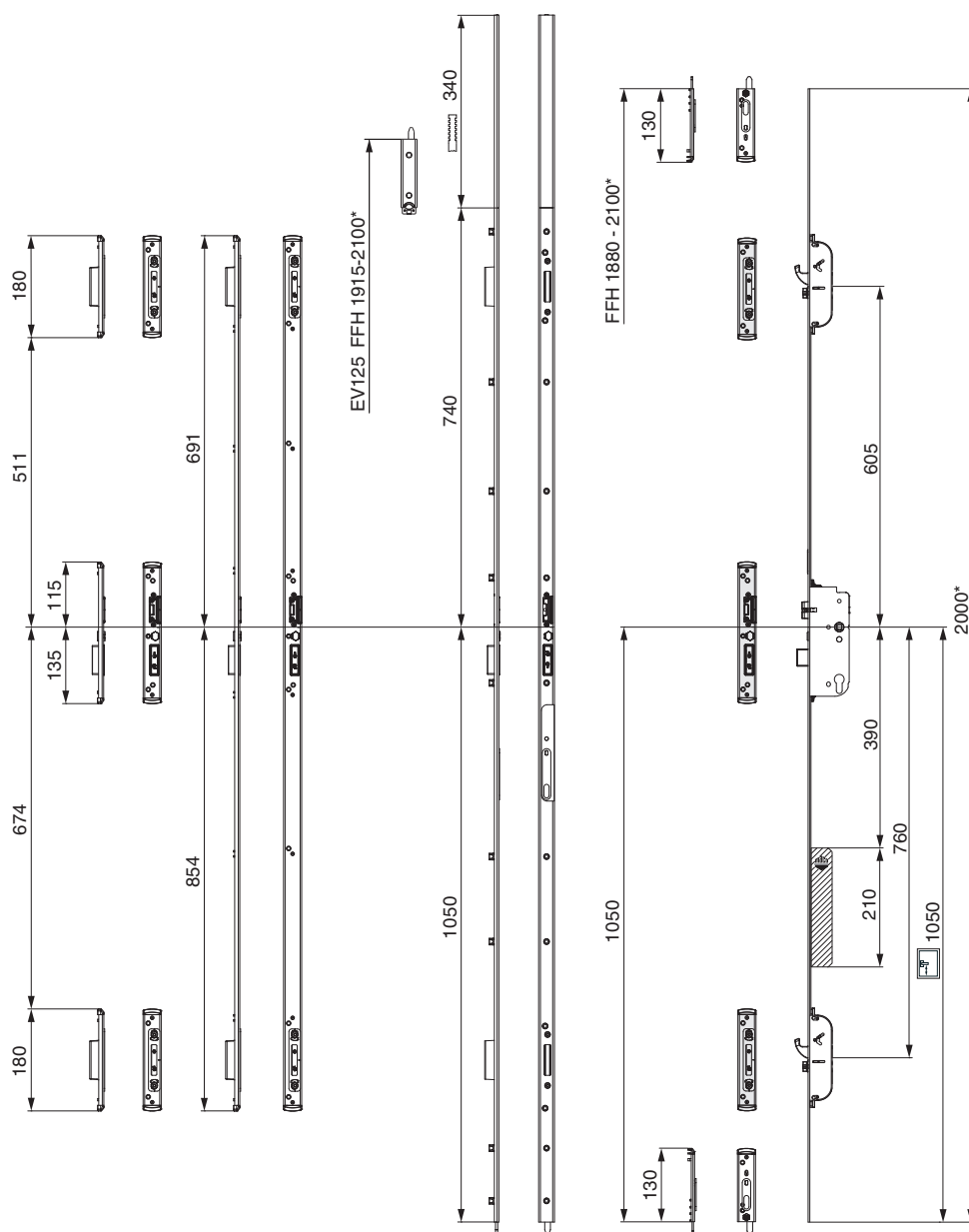

1 e 2 ante



\* Per HBB più alti usare frontali di copertura

 Motore per serratura autobloccante



2 scrochi - ganci K+730

1 e 2 ante

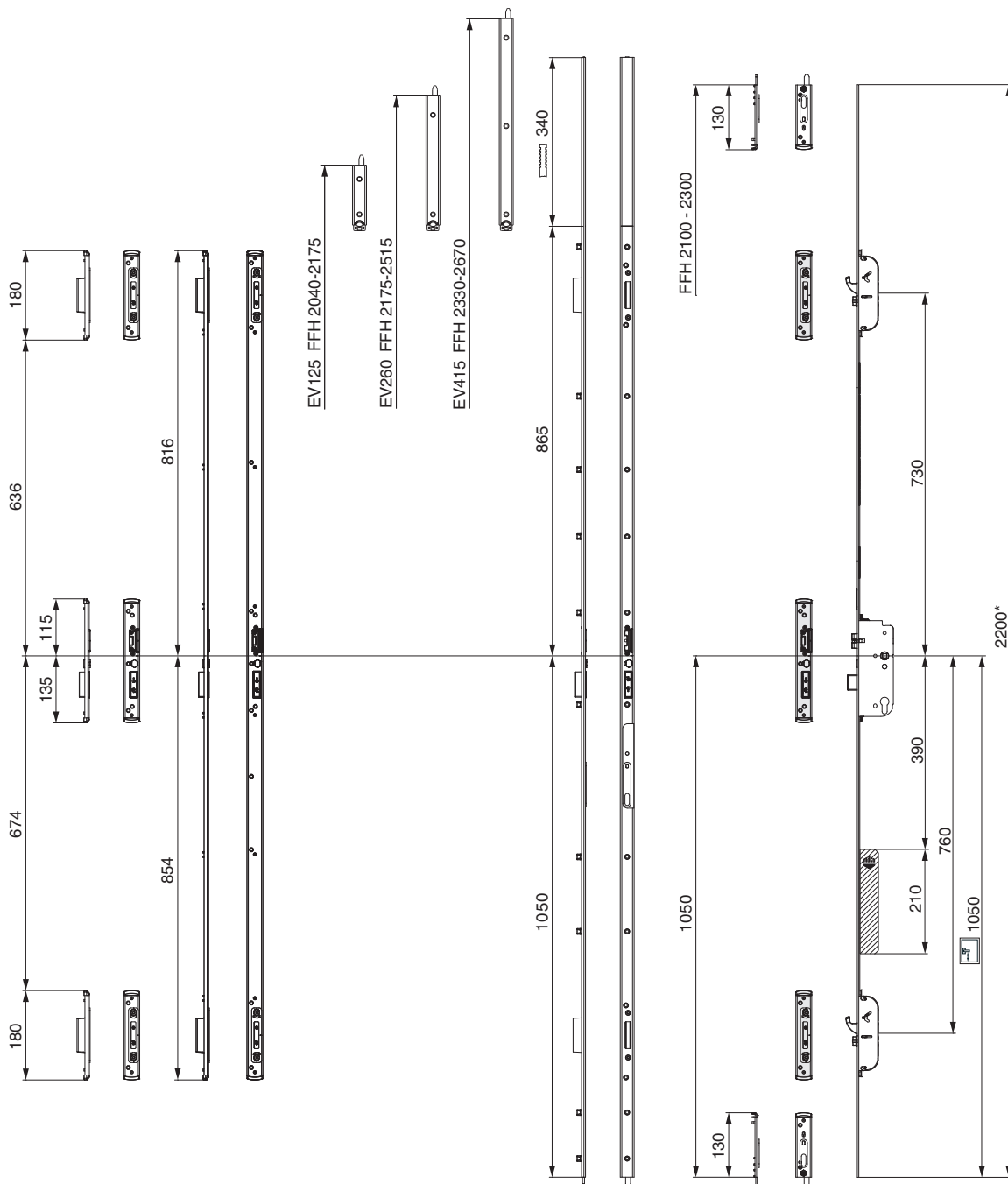

\* Per HBB più alti usare frontali di copertura

☛ Motore per serratura autobloccante



2 scrochi - ganci K+980

1 e 2 ante

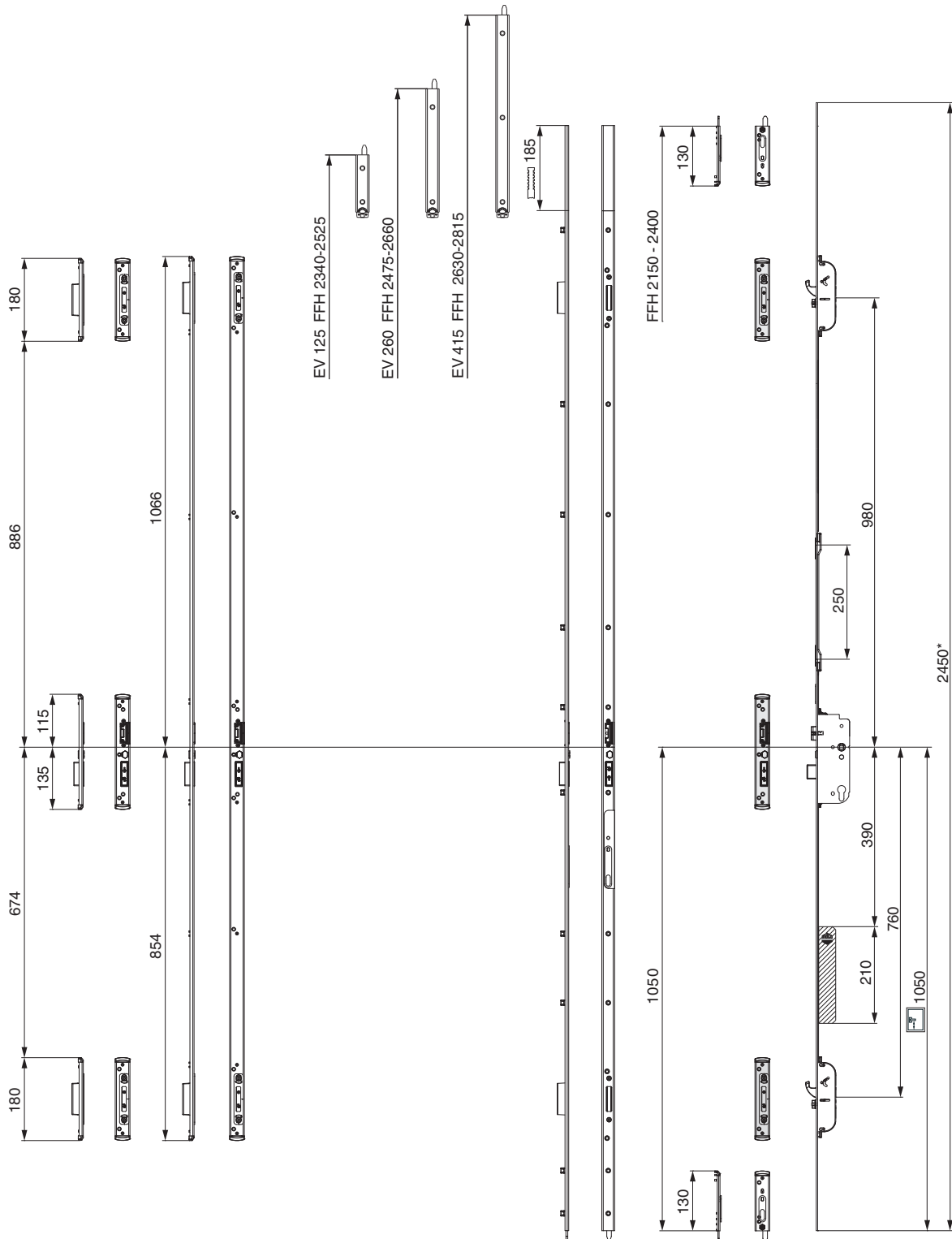





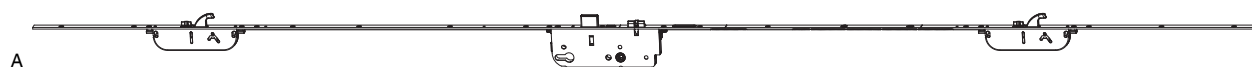

\* Per HBB più alti usare frontali di copertura

● Motore per serratura autobloccante

## 2.2 Serratura autobloccante con 2 scrochi - 2 ganci









A

2.2.1 Serratura autobloccante I92 con 2 scrochi - ganci F16							L		No		
modulare	argento	92	35	8	1.050	2.000 - 2.200	16	2.200	5	A	245000
			40	8	1.050	2.000 - 2.200	16	2.200	5		245001
			45	8	1.050	2.000 - 2.200	16	2.200	5		245002
			50	8	1.050	2.000 - 2.200	16	2.200	5		245003
			55	8	1.050	2.000 - 2.200	16	2.200	5		245004
			65	8	1.050	2.000 - 2.200	16	2.200	5		245006
			70	8	1.050	2.000 - 2.200	16	2.200	5		245007
			80	8	1.050	2.000 - 2.200	16	2.200	5		245008









A

2.2.2 Serratura autobloccante I92 con 2 scrochi - ganci F16 K+605							L		No		
fix	argento	92	35	8	1.050	1.800 - 2.000	16	2.000	5	A	245140
			40	8	1.050	1.800 - 2.000	16	2.000	5		245141
			45	8	1.050	1.800 - 2.000	16	2.000	5		245142
			50	8	1.050	1.800 - 2.000	16	2.000	5		245143
			55	8	1.050	1.800 - 2.000	16	2.000	5		245144
			65	8	1.050	1.800 - 2.000	16	2.000	5		245146
			70	8	1.050	1.800 - 2.000	16	2.000	5		245147
			80	8	1.050	1.800 - 2.000	16	2.000	5		245148









A















2.2.3 Serratura autobloccante I92 con 2 scrochi - ganci F16 K+980							L		No		
fix	argento	92	35	8	1.050	2.200 - 2.400	16	2.400	5	A	245280
			40	8	1.050	2.200 - 2.400	16	2.400	5		260531
			45	8	1.050	2.200 - 2.400	16	2.400	5		260532
			50	8	1.050	2.200 - 2.400	16	2.400	5		245283
			55	8	1.050	2.200 - 2.400	16	2.400	5		245284
			65	8	1.050	2.200 - 2.400	16	2.400	5		245286
			70	8	1.050	2.200 - 2.400	16	2.400	5		260537
			80	8	1.050	2.200 - 2.400	16	2.400	5		260538



A







2.2.4 Serratura autobloccante I92 con 2 scrochi - ganci F20							L		No		
modulare	argento	92	45	8	1.050	2.000 - 2.200	20	2.200	5	A	245012
			50	8	1.050	2.000 - 2.200	20	2.200	5		245013
			55	8	1.050	2.000 - 2.200	20	2.200	5		245014
			65	8	1.050	2.000 - 2.200	20	2.200	5		245016
			70	8	1.050	2.000 - 2.200	20	2.200	5		245017
			80	8	1.050	2.000 - 2.200	20	2.200	5		245018









		A																																																																																																																																																																																																																																																																																																																																																													
<b>2.2.5 Serratura autobloccante I92 con 2 scrochi - ganci F20 K+605</b>																																																																																																																																																																																																																																																																																																																																																															





<b>2.2.14 Serratura autobloccante I92 con 2 scrocci - ganci U-6x24x6 K+605 HM885</b>							<b>L</b>		<b>No</b>		
fix	argento	92	35	8	885	1.800 - 2.000	24	1.615	5	A	<b>245180</b>
			40	8	885	1.800 - 2.000	24	1.615	5		<b>245181</b>
			45	8	885	1.800 - 2.000	24	1.615	5		<b>245182</b>
			50	8	885	1.800 - 2.000	24	1.615	5		<b>245183</b>
			55	8	885	1.800 - 2.000	24	1.615	5		<b>245184</b>





<b>2.2.15 Serratura autobloccante I92 con 2 scrocci - ganci U-6x24x6 K+980 HM885</b>							<b>L</b>		<b>No</b>		
fix	argento	92	35	8	885	2.200 - 2.400	24	1.990	5	A	<b>245320</b>
			40	8	885	2.200 - 2.400	24	1.990	5		<b>245321</b>
			45	8	885	2.200 - 2.400	24	1.990	5		<b>245322</b>
			50	8	885	2.200 - 2.400	24	1.990	5		<b>245323</b>
			55	8	885	2.200 - 2.400	24	1.990	5		<b>245324</b>

## 2.3 Accessori per serratura autobloccante A-TS



### 2.3.1 Prolunga per serratura

Prolunga per serratura autobloccante argento



		L		No
F	16	250	10	A <b>104785</b>
	20	250	10	<b>104786</b>
	24	250	10	<b>104787</b>
	24 / 16	250	10	<b>104788</b>
U	24	250	10	<b>104789<sup>1</sup></b>

<sup>1</sup> da ordine assieme a due pezzi 373861 per parte superiore e inferiore



### 2.3.2 Giunzione accorciamento per serratura

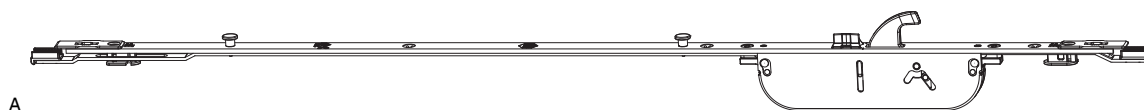

Giunzione accorciamento serratura autobloccante argento

		L		No
F	16	50	10	A <b>104790</b>
	20	50	10	<b>104791</b>
	24	50	10	<b>104792</b>
	24 / 16	50	10	<b>104793</b>
U	24	50	10	<b>104794</b>



### 2.3.3 Prolunga con punto di chiusura

Prolunga per serratura autobloccante con scrocco-gancio argento

		L		No
F	16	705	5	A <b>229773</b>
	20	705	5	<b>229774</b>
	24	705	5	<b>229775</b>
	24 / 16	705	5	<b>229776</b>
U	24	705	5	<b>229777<sup>1</sup></b>

<sup>1</sup> da ordine assieme a due pezzi 373861 per parte superiore e inferiore

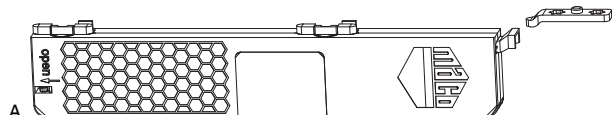

### 2.3.4 Motore per serratura autobloccante

Motore per serratura autobloccante

		No
1	A	<b>104130</b>

### 2.3.5 openDoor

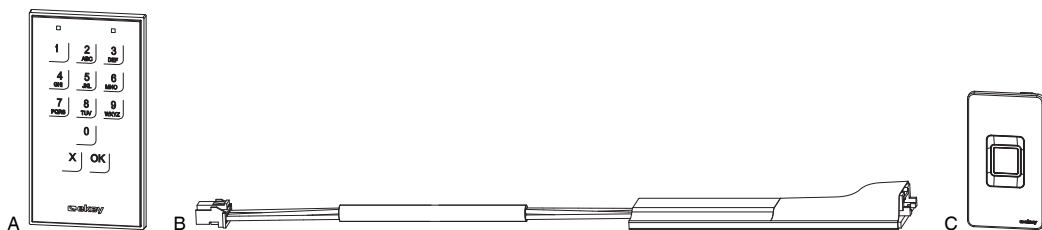

#### 2.3.5.1 Sistemi di accesso



**Nº**

Tastierino numerico	1	A	476515 <sup>1</sup>
Modulo Bluetooth per serratura autobloccante e serratura motorizzata	1	B	480259
openDoor Touchkey dLine	1	C	480489 <sup>1</sup>
openDoor Touchkey dLine lato cerniera	1		481124 <sup>1</sup>

<sup>1</sup> Prodotto commercializzato da MACO. Il produttore di questo articolo® è elencato alla voce "Prodotti commercializzati" nelle "Norme sulla responsabilità del produttore". Per questo prodotto valgono tutte le specifiche tecniche, le note, le istruzioni e le linee guida del produttore, nonché esclusivamente le sue garanzie.

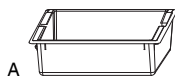

A

#### 2.3.5.2 Scatola incasso per sistemi di accesso





**Nº**

Scatola incasso FS IN per sistema d'accesso ekey	1	A	478181 <sup>1,2</sup>
--	---	---	-----------------------

<sup>1</sup> Prodotto commercializzato da MACO. Il produttore di questo articolo® è elencato alla voce "Prodotti commercializzati" nelle "Norme sulla responsabilità del produttore". Per questo prodotto valgono tutte le specifiche tecniche, le note, le istruzioni e le linee guida del produttore, nonché esclusivamente le sue garanzie.

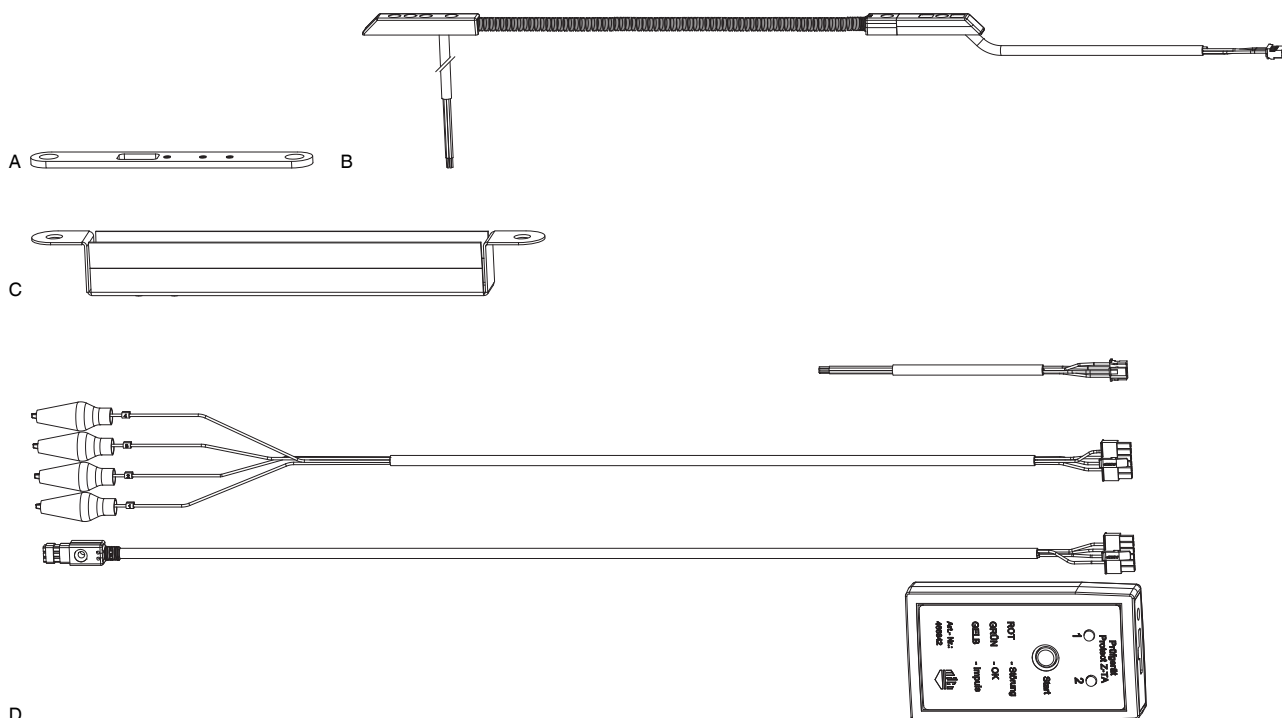
<sup>2</sup> Non adatto per Transponder!



2.3.6 Cavi e accessori per serratura motorizzata aria 4 e aria 12		No
Copertura passacavo F-16 INOX	1	A 363473
Cavo con spina 150 mm	1	466836
Copertura passacavo F-20	1	466838
Cavo con spina 10 m	1	466835
Passacavo con spina 2,5/6 m	1	B 466833
Vaschetta per passacavo A4	1	C 466837
Tester	1	D 466842
Passacavo con spina 2,5/10 m (con 2 connettori JST)	1	466834
Passacavo con spina 1,5/10 m (con 2 connettori JST)	1	481452



2.3.7 Magnete di test per serratura autobloccante		No
Magnete d'azionamento per A-TS e M-TS	20	A 227538

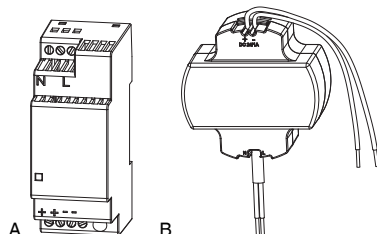

2.3.8 Alimentatori - trasformatori		No
Trasformatore per A-TS e M-TS binario DIN 24V	1	A 480276
Trasformatore per A-TS e M-TS per scatola di derivazione 24V	1	B 480277
Batteria tampone per A-TS e M-TS	1	480987

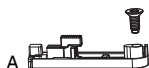

**2.3.9 Blocco meccanismo funzione giorno**



**Nº**

Blocco meccanismo funzione giorno per serratura autobloccante

10

A

**106054**

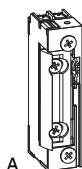

**2.3.10 MACO Scrocco per apertura giorno**



**Nº**

Scrocco per apertura giorno MACO con sblocco meccanico e molla rinforzata

1

A

**478684**

Scrocco per apertura giorno MACO stretto con scivolo per scrocco con sblocco meccanico e molla rinforzata

1

**478686**

Scrocco per apertura giorno MACO per scivolo scrocco con sblocco meccanico e molla rinforzata

1

**478687**

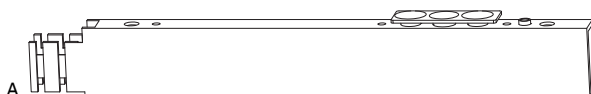
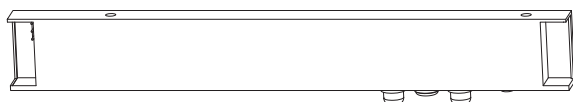

**2.3.11 Passacorrente a contatto**



**Nº**

Passacorrente a contatto SECUREconnect 50

1

A

**478819**

Cavo adattatore 2,5m SECUREconnect 50

1

B

**478821**

Passacorrente a contatto SECUREconnect 50 F-350x20R argento

20

**373646<sup>1</sup>**

<sup>1</sup> Sono necessari 2 frontali di copertura

### 3 Serratura motorizzata (M-TS)

---

<b>3.1</b>	<b>Composizione ferramenta serratura motorizzata</b>	<b>26</b>
<b>3.2</b>	<b>Serratura motorizzata M-TS con 2 scrocci - 2 ganci</b>	<b>28</b>
3.2.1	Serratura motorizzata M-TS PT I92 con 2 scrocci - ganci F24/16	28
3.2.2	Serratura motorizzata M-TS PT I92 con 2 scrocci - ganci F24/16 K+605	28
3.2.3	Serratura motorizzata M-TS PT I92 con 2 scrocci - ganci F24/16 K+980	28
3.2.4	Serratura motorizzata M-TS PT I92 con 2 scrocci - ganci F20	28
3.2.5	Serratura motorizzata M-TS PT I92 con 2 scrocci - ganci F20 K+605	29
3.2.6	Serratura motorizzata M-TS PT I92 con 2 scrocci - ganci F20 K+980	29
3.2.7	Serratura motorizzata M-TS PT I92 con 2 scrocci - ganci F24	29
3.2.8	Serratura motorizzata M-TS PT I92 con 2 scrocci - ganci F24 K+605	29
3.2.9	Serratura motorizzata M-TS PT I92 con 2 scrocci - ganci F24 K+980	29
3.2.10	Serratura motorizzata M-TS PT I92 con 2 scrocci - ganci U-6x24x6 HM885	30
3.2.11	Serratura motorizzata M-TS PT I92 con 2 scrocci - ganci U-6x24x6 HM885 K+605	30
3.2.12	Serratura motorizzata M-TS PT I92 con 2 scrocci - ganci U-6x24x6 K+980	30
<b>3.3</b>	<b>Accessori per serratura motorizzata M-TS</b>	<b>31</b>
3.3.1	openDoor	31
3.3.2	Cavi e accessori per serratura motorizzata aria 4 e aria 12	32
3.3.3	Alimentatori	32
3.3.4	Scontri magnetici	33
3.3.5	Magnete tondo per asta scontri	33
3.3.6	Magnete con biadesivo per asta a leva	33
3.3.7	Magnete di test per serratura autobloccante	33
3.3.8	Scrocco MACO per apertura giorno	33
3.3.9	Passacorrente a contatto	34

### 3 Serratura motorizzata (M-TS)

#### 3.1 Composizione ferramenta serratura motorizzata



2 scrochi - ganci K+605

1 e 2 ante

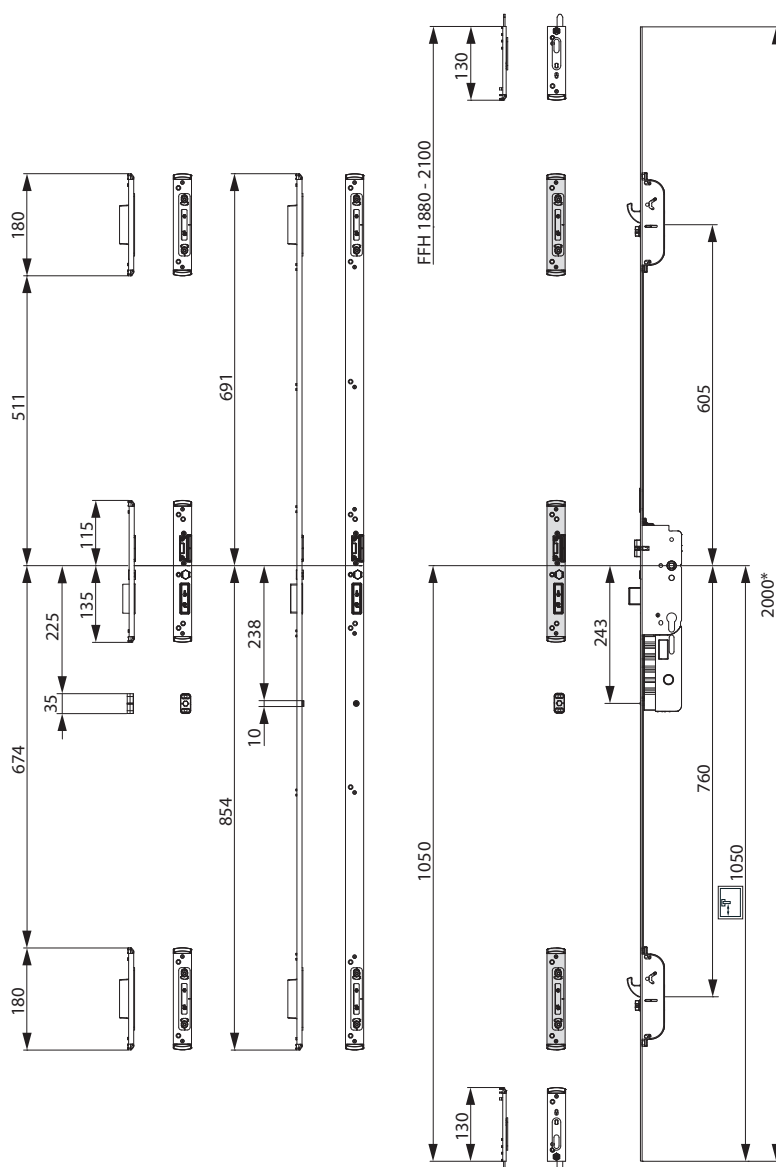

\* Per HBB più alti usare frontali di copertura



2 scrochi - ganci K+980

1 e 2 ante

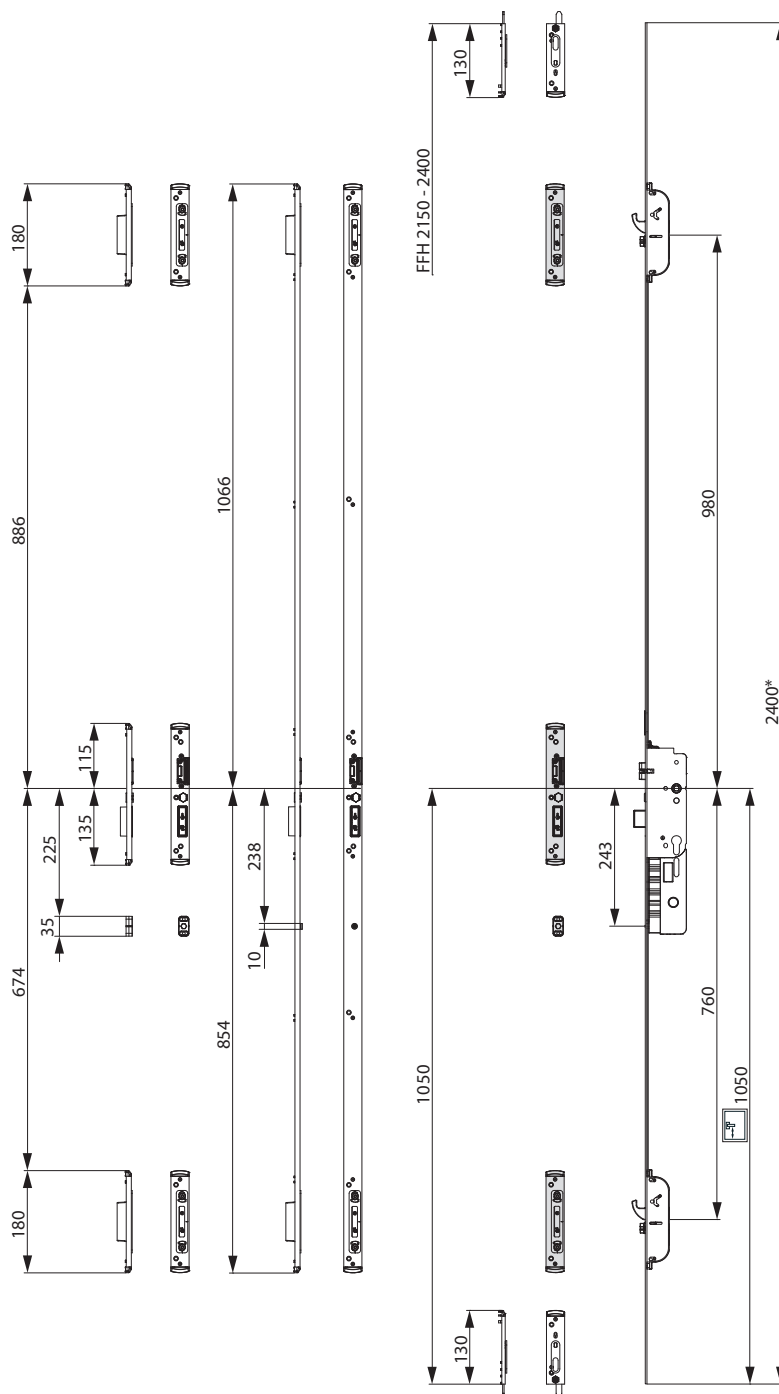

\* Per HBB più alti usare frontali di copertura

Attenzione: Nessuna costruzione modulare possibile!

### 3.2 Serratura motorizzata M-TS con 2 scrocci - 2 ganci

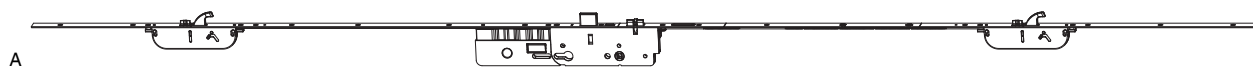

#### 3.2.1 Serratura motorizzata M-TS PT I92 con 2 scrocci - ganci F24/16

fix	argento	92	35	8	1.050	2.000 - 2.200	24/16	2.200	1	A	No
			40	8	1.050	2.000 - 2.200	24/16	2.200	1		245531
			45	8	1.050	2.000 - 2.200	24/16	2.200	1		245532
			50	8	1.050	2.000 - 2.200	24/16	2.200	1		245533
			55	8	1.050	2.000 - 2.200	24/16	2.200	1		245534
			65	8	1.050	2.000 - 2.200	24/16	2.200	1		245536
			80	8	1.050	2.000 - 2.200	24/16	2.200	1		245538



#### 3.2.2 Serratura motorizzata M-TS PT I92 con 2 scrocci - ganci F24/16 K+605

fix	argento	92	35	8	1.050	1.800 - 2.000	24/16	2.000	1	A	No
			40	8	1.050	1.800 - 2.000	24/16	2.000	1		245671
			45	8	1.050	1.800 - 2.000	24/16	2.000	1		245672
			50	8	1.050	1.800 - 2.000	24/16	2.000	1		245673
			55	8	1.050	1.800 - 2.000	24/16	2.000	1		245674
			65	8	1.050	1.800 - 2.000	24/16	2.000	1		245676
			80	8	1.050	1.800 - 2.000	24/16	2.000	1		245678



#### 3.2.3 Serratura motorizzata M-TS PT I92 con 2 scrocci - ganci F24/16 K+980

fix	argento	92	35	8	1.050	2.200 - 2.400	24/16	2.400	1	A	No
			40	8	1.050	2.200 - 2.400	24/16	2.400	1		261411
			45	8	1.050	2.200 - 2.400	24/16	2.400	1		261412
			50	8	1.050	2.200 - 2.400	24/16	2.400	1		261413
			55	8	1.050	2.200 - 2.400	24/16	2.400	1		261414
			65	8	1.050	2.200 - 2.400	24/16	2.400	1		261416
			80	8	1.050	2.200 - 2.400	24/16	2.400	1		261418



#### 3.2.4 Serratura motorizzata M-TS PT I92 con 2 scrocci - ganci F20

fix	argento	92	55	8	1.050	2.000 - 2.200	20	2.200	1	A	No
			65	8	1.050	2.000 - 2.200	20	2.200	1		245516
			80	8	1.050	2.000 - 2.200	20	2.200	1		245518



A

**3.2.5 Serratura motorizzata M-TS PT I92 con 2 scrocci - ganci F20 K+605**



fix	argento	92	55	8	1.050	1.800 - 2.000	20	2.000	1	A	<b>№</b>
			65	8	1.050	1.800 - 2.000	20	2.000	1		<b>245654</b>
			80	8	1.050	1.800 - 2.000	20	2.000	1		<b>245656</b>
											<b>245658</b>



A

**3.2.6 Serratura motorizzata M-TS PT I92 con 2 scrocci - ganci F20 K+980**



fix	argento	92	55	8	1.050	2.200 - 2.400	20	2.400	1	A	<b>№</b>
			65	8	1.050	2.200 - 2.400	20	2.400	1		<b>261394</b>
											<b>261396</b>



A

**3.2.7 Serratura motorizzata M-TS PT I92 con 2 scrocci - ganci F24**



fix	argento	92	35	8	1.050	2.000 - 2.200	24	2.200	1	A	<b>№</b>
			40	8	1.050	2.000 - 2.200	24	2.200	1		<b>245520</b>
			45	8	1.050	2.000 - 2.200	24	2.200	1		<b>245521</b>
											<b>245522</b>



A

**3.2.8 Serratura motorizzata M-TS PT I92 con 2 scrocci - ganci F24 K+605**



fix	argento	92	35	8	1.050	1.800 - 2.000	24	2.000	1	A	<b>№</b>
			40	8	1.050	1.800 - 2.000	24	2.000	1		<b>245660</b>
			45	8	1.050	1.800 - 2.000	24	2.000	1		<b>245661</b>
											<b>245662</b>



A





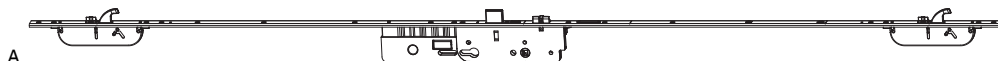

**3.2.9 Serratura motorizzata M-TS PT I92 con 2 scrocci - ganci F24 K+980**



fix	argento	92	35	8	1.050	2.200 - 2.400	24	2.400	1	A	<b>№</b>
			40	8	1.050	2.200 - 2.400	24	2.400	1		<b>261400</b>
			45	8	1.050	2.200 - 2.400	24	2.400	1		<b>261401</b>
											<b>261402</b>









A

<b>3.2.10 Serratura motorizzata M-TS PT I92 con 2 scrocci - ganci U-6x24x6 HM885</b>							<b>L</b>		<b>No</b>		
fix	argento	92	35	8	885	2.000 - 2.200	24	1.740	1	A	<b>245540</b>
			40	8	885	2.000 - 2.200	24	1.740	1		<b>245541</b>
			45	8	885	2.000 - 2.200	24	1.740	1		<b>245542</b>
			50	8	885	2.000 - 2.200	24	1.740	1		<b>245543</b>
			55	8	885	2.000 - 2.200	24	1.740	1		<b>245544</b>









A

<b>3.2.11 Serratura motorizzata M-TS PT I92 con 2 scrocci - ganci U-6x24x6 HM885 K+605</b>							<b>L</b>		<b>No</b>		
fix	argento	92	35	8	885	1.800 - 2.000	24	1.615	1	A	<b>245680</b>
			40	8	885	1.800 - 2.000	24	1.615	1		<b>245681</b>
			45	8	885	1.800 - 2.000	24	1.615	1		<b>245682</b>
			50	8	885	1.800 - 2.000	24	1.615	1		<b>245683</b>
			55	8	885	1.800 - 2.000	24	1.615	1		<b>245684</b>



A

<b>3.2.12 Serratura motorizzata M-TS PT I92 con 2 scrocci - ganci U-6x24x6 K+980</b>							<b>L</b>		<b>No</b>		
fix	argento	92	35	8	885	2.200 - 2.400	24	1.990	1	A	<b>245820</b>
			40	8	885	2.200 - 2.400	24	1.990	1		<b>245821</b>
			45	8	885	2.200 - 2.400	24	1.990	1		<b>245822</b>
			50	8	885	2.200 - 2.400	24	1.990	1		<b>245823</b>
			55	8	885	2.200 - 2.400	24	1.990	1		<b>245824</b>

### 3.3 Accessori per serratura motorizzata M-TS

#### 3.3.1 openDoor

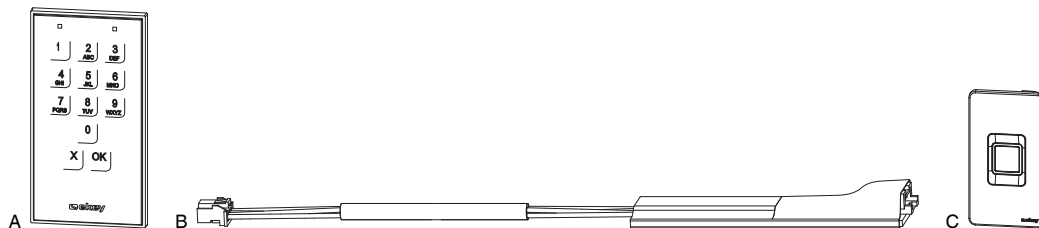

##### 3.3.1.1 Sistemi di accesso

			<b>N°</b>
Tastierino numerico	1	A	<b>476515<sup>1</sup></b>
Modulo Bluetooth per serratura autobloccante e serratura motorizzata	1	B	<b>480259</b>
openDoor Touchkey dLine	1	C	<b>480489<sup>1</sup></b>
openDoor Touchkey dLine lato cerniera	1		<b>481124<sup>1</sup></b>

<sup>1</sup> Prodotto commercializzato da MACO. Il produttore di questo articolo® è elencato alla voce "Prodotti commercializzati" nelle "Norme sulla responsabilità del produttore". Per questo prodotto valgono tutte le specifiche tecniche, le note, le istruzioni e le linee guida del produttore, nonché esclusivamente le sue garanzie.





##### 3.3.1.2 Scatola incasso per sistemi di accesso

			<b>N°</b>
Scatola incasso FS IN per sistema d'accesso ekey	1	A	<b>478181<sup>1,2</sup></b>

<sup>1</sup> Prodotto commercializzato da MACO. Il produttore di questo articolo® è elencato alla voce "Prodotti commercializzati" nelle "Norme sulla responsabilità del produttore". Per questo prodotto valgono tutte le specifiche tecniche, le note, le istruzioni e le linee guida del produttore, nonché esclusivamente le sue garanzie.

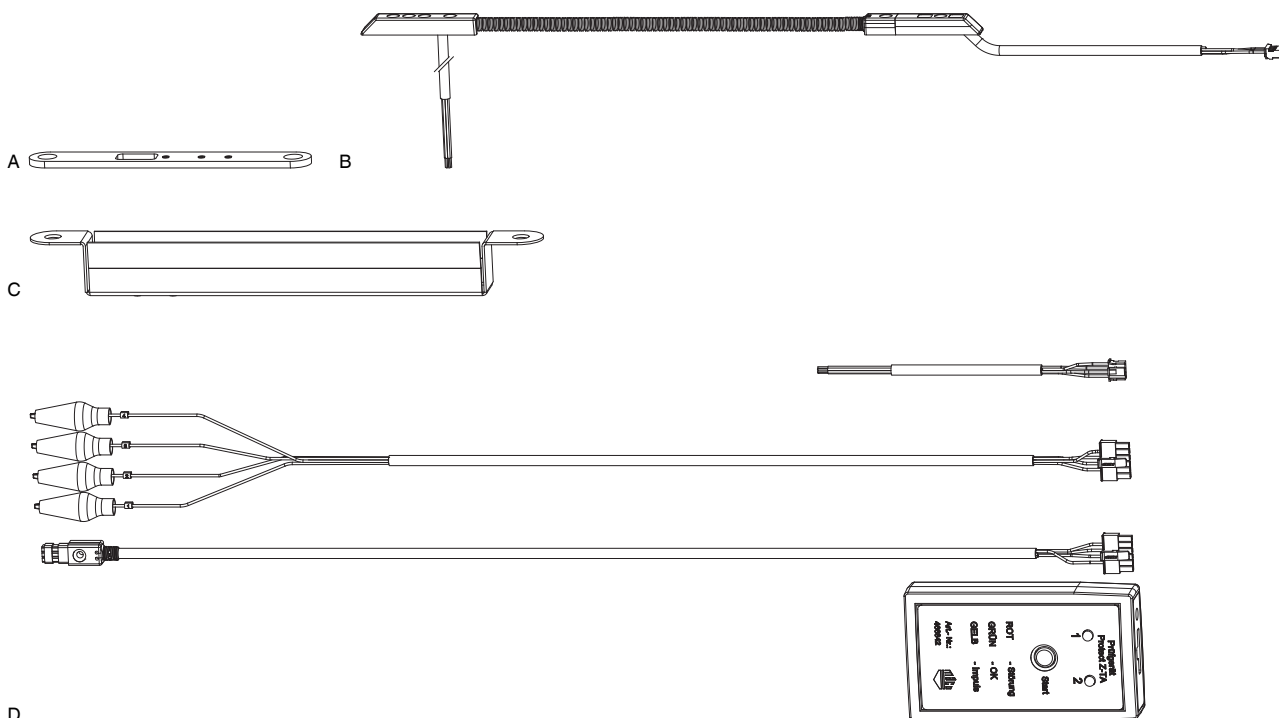
<sup>2</sup> Non adatto per Transponder!



3.3.2 Cavi e accessori per serratura motorizzata aria 4 e aria 12			<b>N°</b>
Copertura passacavo F-16 INOX	1	A	363473
Cavo con spina 150 mm	1		466836
Copertura passacavo F-20	1		466838
Cavo con spina 10 m	1		466835
Passacavo con spina 2,5/6 m	1	B	466833
Vaschetta per passacavo A4	1	C	466837
Tester	1	D	466842
Passacavo con spina 2,5/10 m (con 2 connettori JST)	1		466834
Passacavo con spina 1,5/10 m (con 2 connettori JST)	1		481452

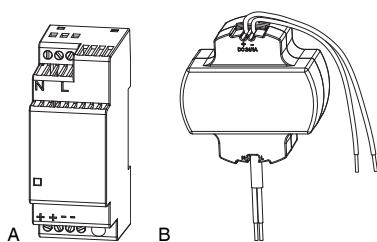

3.3.3 Alimentatori			<b>N°</b>
Trasformatore per A-TS e M-TS binario DIN 24V	1	A	480276
Trasformatore per A-TS e M-TS per scatola di derivazione 24V	1	B	480277
Batteria tampone per A-TS e M-TS	1		480987

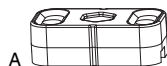

A

### 3.3.4 Scontri magnetici



**Nº**

Scontro magnetico M-TS per PVC Veka + Schüco IS82 argento	20	A	<b>229381</b>
Scontro magnetico M-TS A12 scost.13 mm argento	20		<b>229382</b>
Scontro magnetico M-TS per alluminio argento	20		<b>229383</b>
Scontro magnetico M-TS legno A4 argento	20		<b>229384</b>
Scontro magnetico M-TS per PVC Aluplast 4000/7000 argento	20		<b>250461</b>
Scontro magnetico M-TS per PVC Profine 76/88 + Salamander BE92 + Deceuninck Zendow argento	20		<b>250462</b>
Scontro magnetico M-TS scost.13mm per cava ferramenta contrapposta legno/PVC argento	20		<b>250593</b>



A

### 3.3.5 Magnete tondo per asta scontri



**Nº**

Magnete tondo per asta scontri M-TS 2 mm	10	A	<b>106144</b>
--	----	---	---------------



A

### 3.3.6 Magnete con biadesivo per asta a leva



**Nº**

Magnete M-TS con biadesivo per asta a leva 20mm x 10mm	10	A	<b>373147</b>
--	----	---	---------------



A

### 3.3.7 Magnete di test per serratura autobloccante



**Nº**

Magnete d'azionamento per A-TS e M-TS	20	A	<b>227538</b>
---------------------------------------	----	---	---------------

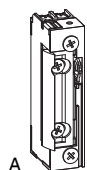

A

### 3.3.8 Scrocco MACO per apertura giorno



**Nº**

Scrocco per apertura giorno MACO con sblocco meccanico e molla rinforzata	1	A	<b>478684</b>
Scrocco per apertura giorno MACO stretto con scivolo per scrocco con sblocco meccanico e molla rinforzata	1		<b>478686</b>
Scrocco per apertura giorno MACO per scivolo scrocco con sblocco meccanico e molla rinforzata	1		<b>478687</b>

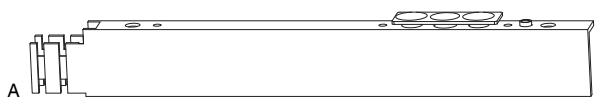
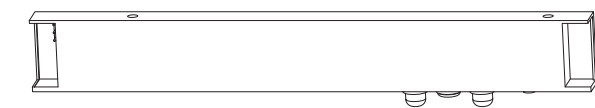

3.3.9 Passacorrente a contatto		No
Passacorrente a contatto SECUREconnect 50	1	A <b>478819</b>
Cavo adattatore 2,5m SECUREconnect 50	1	B <b>478821</b>
Passacorrente a contatto SECUREconnect 50 F-350x20R argento	20	<b>373646<sup>1</sup></b>

<sup>1</sup> Sono necessari 2 frontali di copertura



#### **4 Serratura automatica comando cilindro (Z-TF)**

---

- 4.1 Composizione ferramenta serratura automatica comando cilindro con scrochi-ganci 36**
- 4.2 Serratura automatica comando cilindro con 2 scrochi - ganci \_\_\_\_\_ 39**

## 4 Serratura automatica comando cilindro (Z-TF)

### 4.1 Composizione ferramenta serratura automatica comando cilindro con scrochi-ganci



2 scrochi - ganci K+605

1 e 2 ante

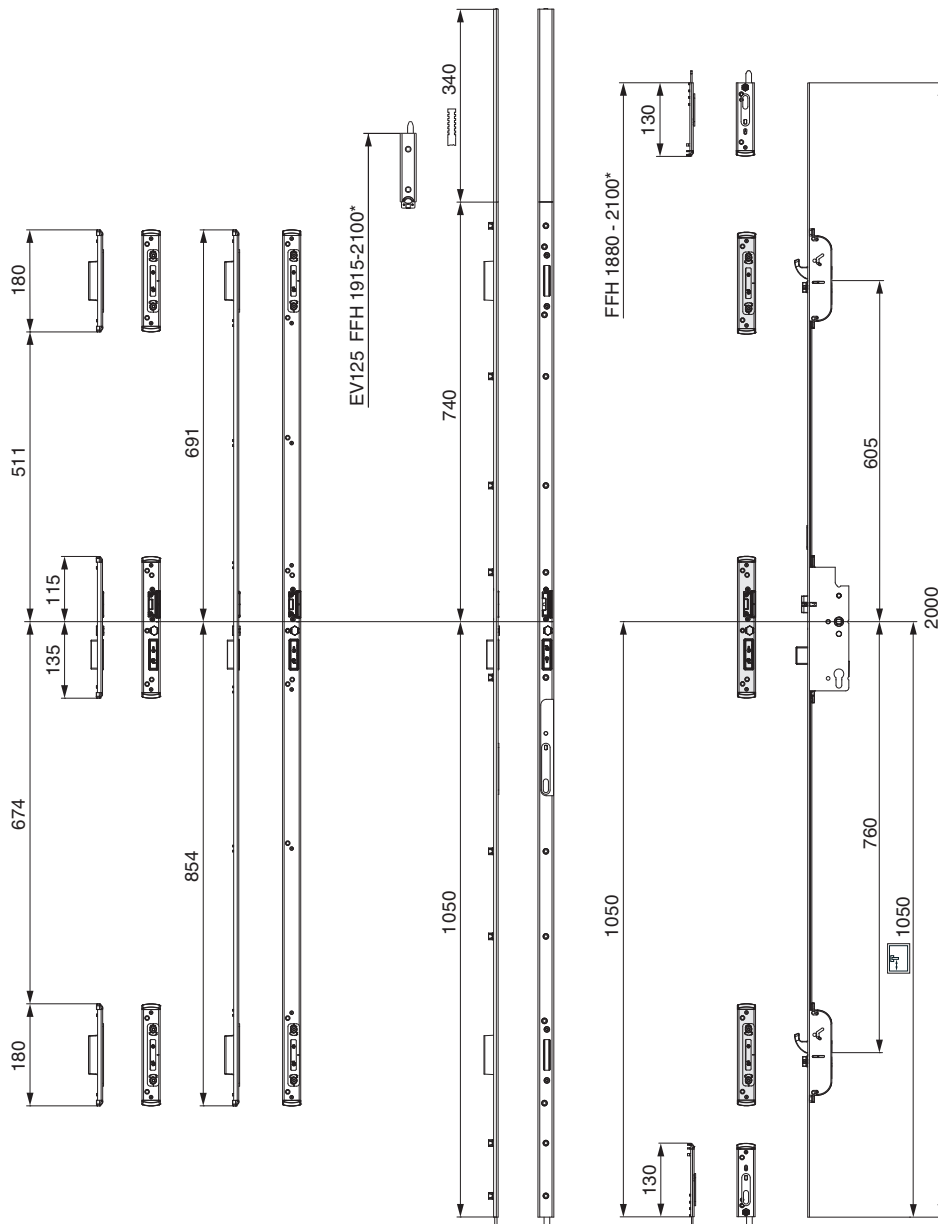



2 scrochi - ganci K+730

1 e 2 ante

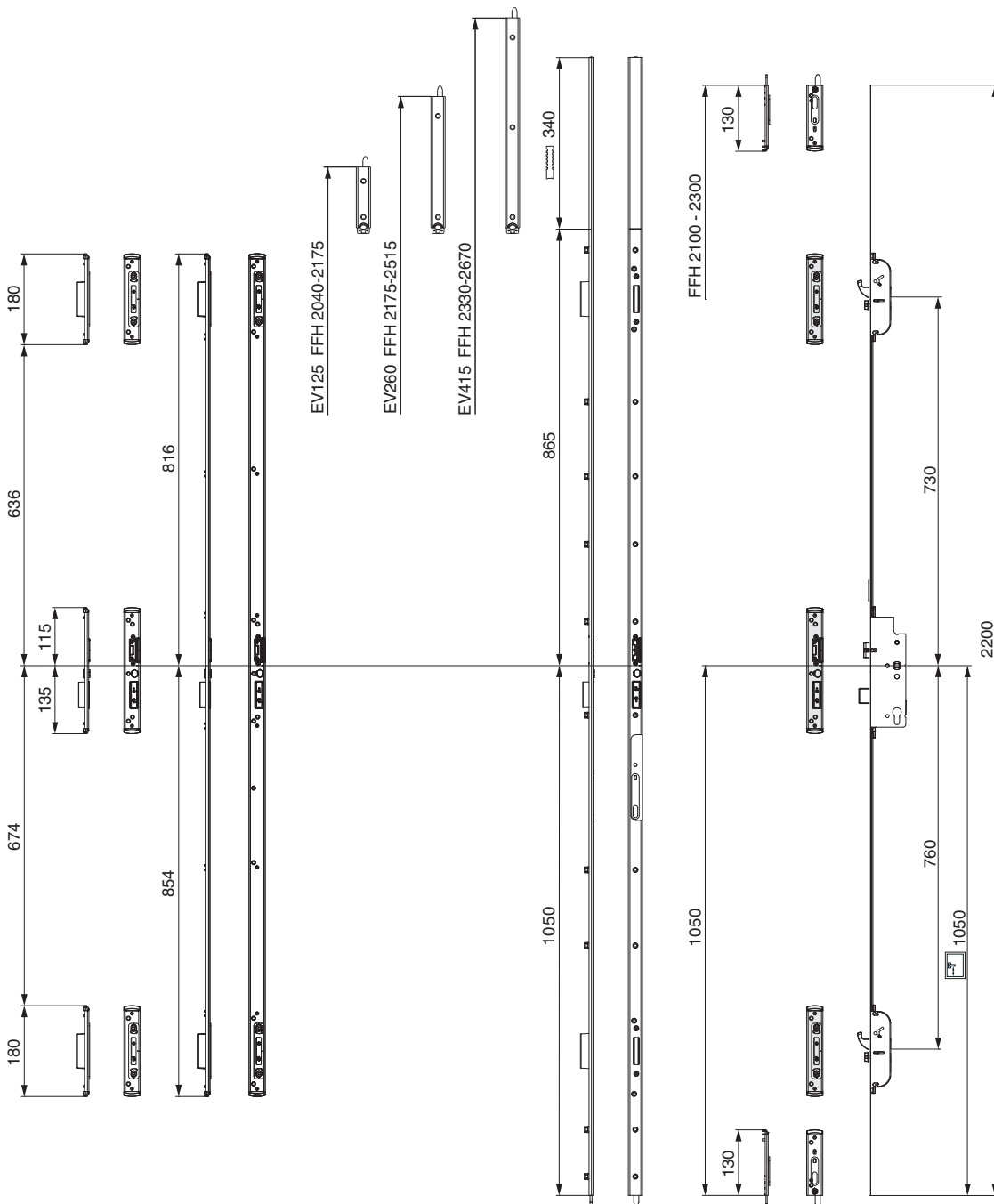



2 scrochi - ganci K+980



1 e 2 ante

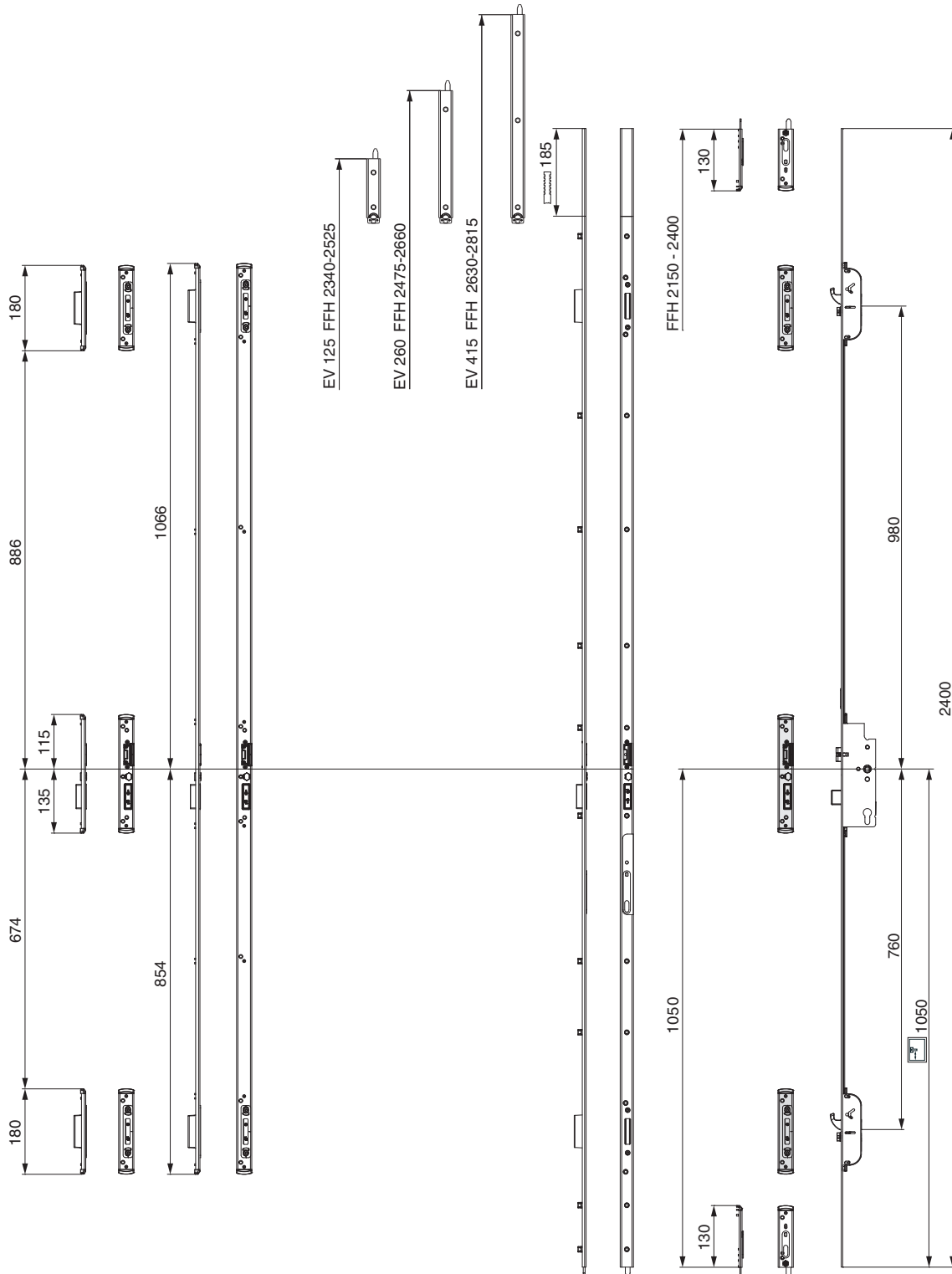

## 4.2 Serratura automatica comando cilindro con 2 scrocci - ganci



A

### 4.2.1 Serratura automatica I92 con 2 scrocci - ganci F16



fix	argento	92	35	8	1.050	2.000 - 2.200	16	2.200	5	A	No
			40	8	1.050	2.000 - 2.200	16	2.200	5		231411
			45	8	1.050	2.000 - 2.200	16	2.200	5		231412
			50	8	1.050	2.000 - 2.200	16	2.200	5		231413
			55	8	1.050	2.000 - 2.200	16	2.200	5		231414
			65	8	1.050	2.000 - 2.200	16	2.200	5		231415



A

### 4.2.2 Serratura automatica I92 con 2 scrocci - ganci F16 K+605



fix	argento	92	35	8	1.050	1.800 - 2.000	16	2.000	5	A	No
			40	8	1.050	1.800 - 2.000	16	2.000	5		231451
			45	8	1.050	1.800 - 2.000	16	2.000	5		231452
			50	8	1.050	1.800 - 2.000	16	2.000	5		231453
			55	8	1.050	1.800 - 2.000	16	2.000	5		231454
			65	8	1.050	1.800 - 2.000	16	2.000	5		231455



A

### 4.2.3 Serratura automatica I92 con 2 scrocci - ganci F16 K+980



fix	argento	92	35	8	1.050	2.200 - 2.400	16	2.400	5	A	No
			40	8	1.050	2.200 - 2.400	16	2.400	5		231491
			45	8	1.050	2.200 - 2.400	16	2.400	5		231492
			50	8	1.050	2.200 - 2.400	16	2.400	5		231493
			55	8	1.050	2.200 - 2.400	16	2.400	5		231494
			65	8	1.050	2.200 - 2.400	16	2.400	5		231495



A







### 4.2.4 Serratura automatica I92 con 2 scrocci - ganci F20



fix	argento	92	45	8	1.050	2.000 - 2.200	20	2.200	5	A	No
			50	8	1.050	2.000 - 2.200	20	2.200	5		230563
			55	8	1.050	2.000 - 2.200	20	2.200	5		230564
			65	8	1.050	2.000 - 2.200	20	2.200	5		230565
			80	8	1.050	2.000 - 2.200	20	2.200	5		230567









A

<b>4.2.5 Serratura automatica I92 con 2 scrocchi - ganci F20 K+605</b>								<b>L</b>		<b>No</b>
fix	argento	92	45	8	1.050	1.800 - 2.000	20	2.000	5	A <b>230632</b>
			50	8	1.050	1.800 - 2.000	20	2.000	5	<b>230633</b>
			55	8	1.050	1.800 - 2.000	20	2.000	5	<b>230634</b>
			65	8	1.050	1.800 - 2.000	20	2.000	5	<b>230635</b>
			80	8	1.050	1.800 - 2.000	20	2.000	5	<b>230637</b>









A

<b>4.2.6 Serratura automatica I92 con 2 scrocchi - ganci F20 K+980</b>								<b>L</b>		<b>No</b>
fix	argento	92	45	8	1.050	2.200 - 2.400	20	2.400	5	A <b>230642</b>
			50	8	1.050	2.200 - 2.400	20	2.400	5	<b>230643</b>
			55	8	1.050	2.200 - 2.400	20	2.400	5	<b>230644</b>
			65	8	1.050	2.200 - 2.400	20	2.400	5	<b>230645</b>
			80	8	1.050	2.200 - 2.400	20	2.400	5	<b>230647</b>









A

<b>4.2.7 Serratura automatica I92 con 2 scrocchi - ganci F24</b>								<b>L</b>		<b>No</b>
fix	argento	92	35	8	1.050	2.000 - 2.200	24	2.200	5	A <b>232330</b>
			40	8	1.050	2.000 - 2.200	24	2.200	5	<b>232331</b>
			45	8	1.050	2.000 - 2.200	24	2.200	5	<b>232332</b>









A

<b>4.2.8 Serratura automatica I92 con 2 scrocchi - ganci F24 K+605</b>								<b>L</b>		<b>No</b>
fix	argento	92	35	8	1.050	1.800 - 2.000	24	2.000	5	A <b>232340</b>
			40	8	1.050	1.800 - 2.000	24	2.000	5	<b>232341</b>
			45	8	1.050	1.800 - 2.000	24	2.000	5	<b>232342</b>



A

<b>4.2.9 Serratura automatica I92 con 2 scrocchi - ganci F24 K+980</b>								<b>L</b>		<b>No</b>
fix	argento	92	35	8	1.050	2.200 - 2.400	24	2.400	5	A <b>232350</b>
			40	8	1.050	2.200 - 2.400	24	2.400	5	<b>232351</b>
			45	8	1.050	2.200 - 2.400	24	2.400	5	<b>232352</b>

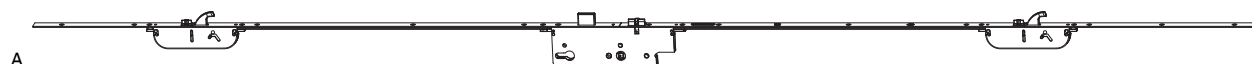

**4.2.10 Serratura automatica I92 con 2 scroccchi - ganci F24/16**



fix	argento	92	35	8	1.050	2.000 - 2.200	24/16	2.200	5	A	No
			40	8	1.050	2.000 - 2.200	24/16	2.200	5		230531
			45	8	1.050	2.000 - 2.200	24/16	2.200	5		230532
			50	8	1.050	2.000 - 2.200	24/16	2.200	5		230533
			55	8	1.050	2.000 - 2.200	24/16	2.200	5		230534
			65	8	1.050	2.000 - 2.200	24/16	2.200	5		230535
			80	8	1.050	2.000 - 2.200	24/16	2.200	5		230537

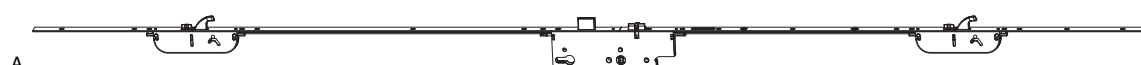

**4.2.11 Serratura automatica I92 con 2 scroccchi - ganci F24/16 K+605**



fix	argento	92	35	8	1.050	1.800 - 2.000	24/16	2.000	5	A	No
			40	8	1.050	1.800 - 2.000	24/16	2.000	5		230541
			45	8	1.050	1.800 - 2.000	24/16	2.000	5		230542
			50	8	1.050	1.800 - 2.000	24/16	2.000	5		230543
			55	8	1.050	1.800 - 2.000	24/16	2.000	5		230544
			65	8	1.050	1.800 - 2.000	24/16	2.000	5		230545
			80	8	1.050	1.800 - 2.000	24/16	2.000	5		230547



**4.2.12 Serratura automatica I92 con 2 scroccchi - ganci F24/16 K+980**



fix	argento	92	35	8	1.050	2.200 - 2.400	24/16	2.400	5	A	No
			40	8	1.050	2.200 - 2.400	24/16	2.400	5		230551
			45	8	1.050	2.200 - 2.400	24/16	2.400	5		230552
			50	8	1.050	2.200 - 2.400	24/16	2.400	5		230553
			55	8	1.050	2.200 - 2.400	24/16	2.400	5		230554
			65	8	1.050	2.200 - 2.400	24/16	2.400	5		230555
			80	8	1.050	2.200 - 2.400	24/16	2.400	5		230557

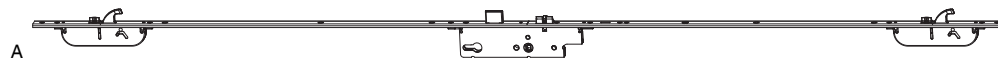

**4.2.13 Serratura automatica I92 con 2 scroccchi - ganci U-6x24x6 HM885**

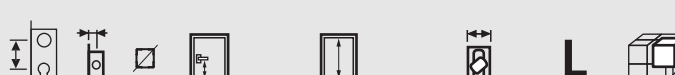

fix	argento	92	35	8	885	2.000 - 2.200	24	1.740	5	A	No
			40	8	885	2.000 - 2.200	24	1.740	5		231541
			45	8	885	2.000 - 2.200	24	1.740	5		231542
			50	8	885	2.000 - 2.200	24	1.740	5		231543
			55	8	885	2.000 - 2.200	24	1.740	5		231544



**4.2.14 Serratura automatica I92 con 2 scrocci - ganci U-6x24x6 HM885 K+605**



fix	argento	92	35	8	885	1.800 - 2.000	24	1.615	5	A	<b>Nº</b>
			40	8	885	1.800 - 2.000	24	1.615	5		<b>231550</b>
			45	8	885	1.800 - 2.000	24	1.615	5		<b>231551</b>
			50	8	885	1.800 - 2.000	24	1.615	5		<b>231552</b>
			55	8	885	1.800 - 2.000	24	1.615	5		<b>231553</b>
											<b>231554</b>



**4.2.15 Serratura automatica I92 con 2 scrocci - ganci U-6x24x6 HM885 K+980**



fix	argento	92	35	8	885	2.200 - 2.400	24	1.990	5	A	<b>Nº</b>
			40	8	885	2.200 - 2.400	24	1.990	5		<b>231570</b>
			45	8	885	2.200 - 2.400	24	1.990	5		<b>231571</b>
			50	8	885	2.200 - 2.400	24	1.990	5		<b>231572</b>
			55	8	885	2.200 - 2.400	24	1.990	5		<b>231573</b>
											<b>231574</b>



## 5 Serratura comando cilindro mod. (Z-TS)

---

5.1	Composizione ferramenta serratura comando cilindro _____	44
5.2	Serratura comando cilindro modulare con funghi _____	49
5.3	Serratura comando cilindro modulare con ganci-punzoni e funghi _____	50
5.4	Serratura comando cilindro modulare con ganci-punzoni _____	51
5.5	Terminale per serratura comando cilindro e maniglia _____	53
5.6	Accessori per serrature modulari _____	55

## 5 Serratura comando cilindro mod. (Z-TS)

### 5.1 Composizione ferramenta serratura comando cilindro

3.1m

La costruzione 'modulare' di PROTECT MODUL

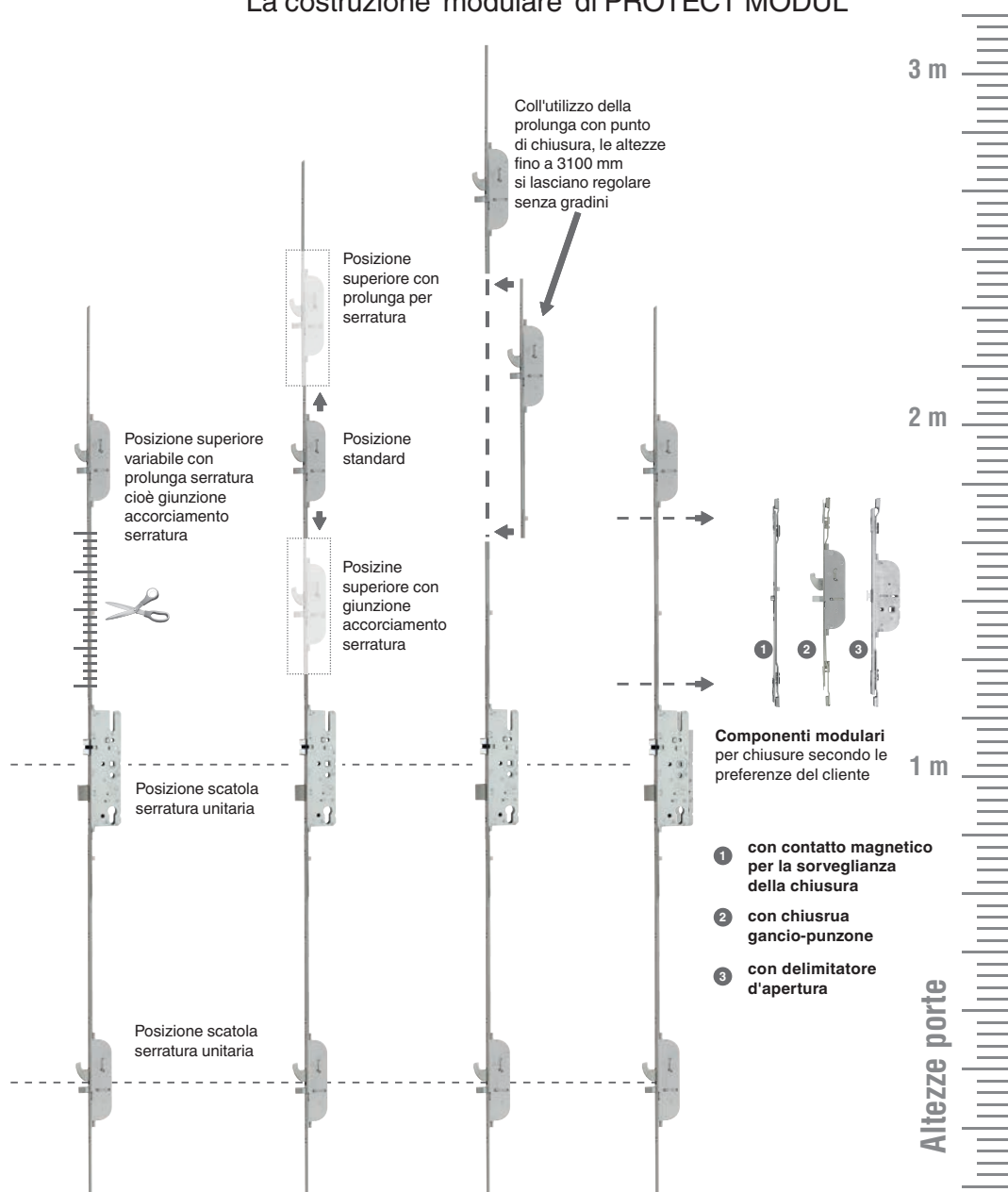

### Posizione scatola serratura unitaria

- ① Combinazione con 2 ganci e 2 punzoni
- ② Combinazione con 4 ganci e 4 punzoni

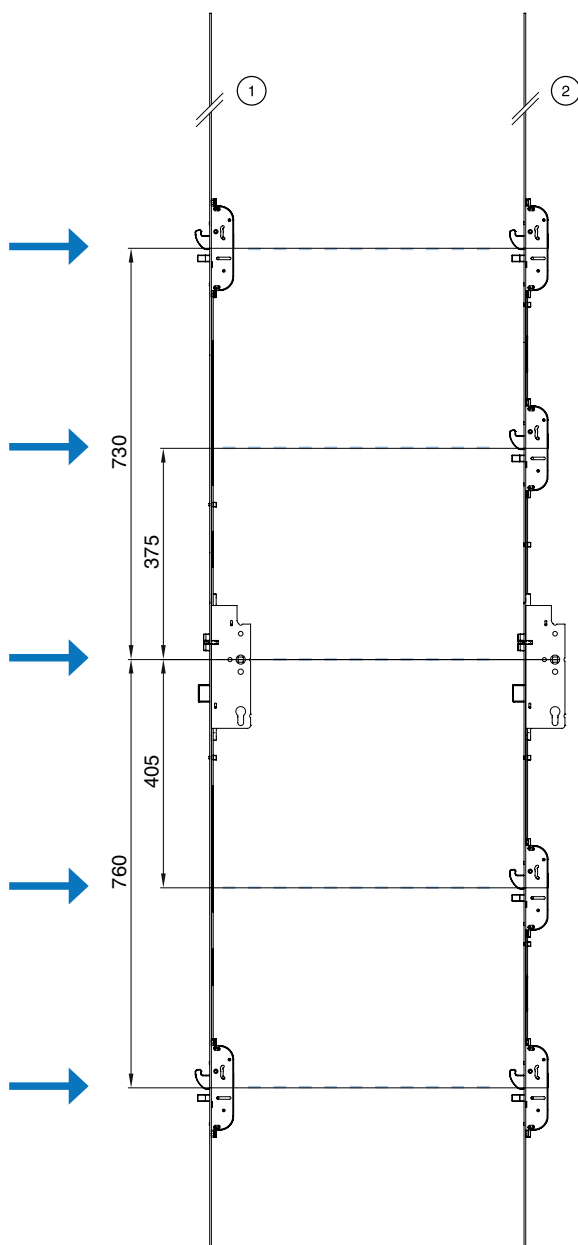

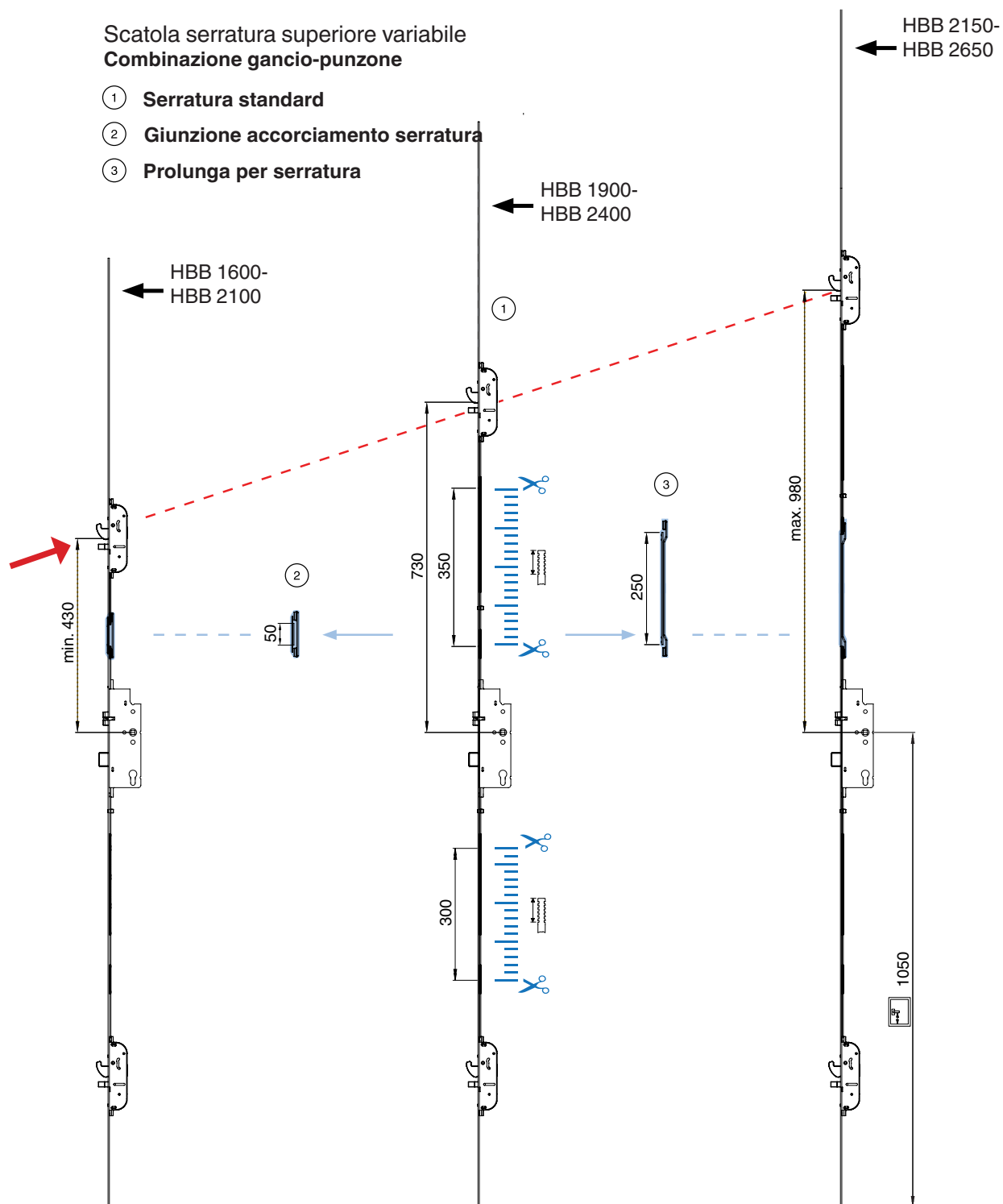

Componenti frontali variabili

- ① Serratura standard
- ② Componente frontale con gancio-punzone
- ③ Componente frontale con contatto magnetico
- ④ Componente frontale con delimitatore d'apertura

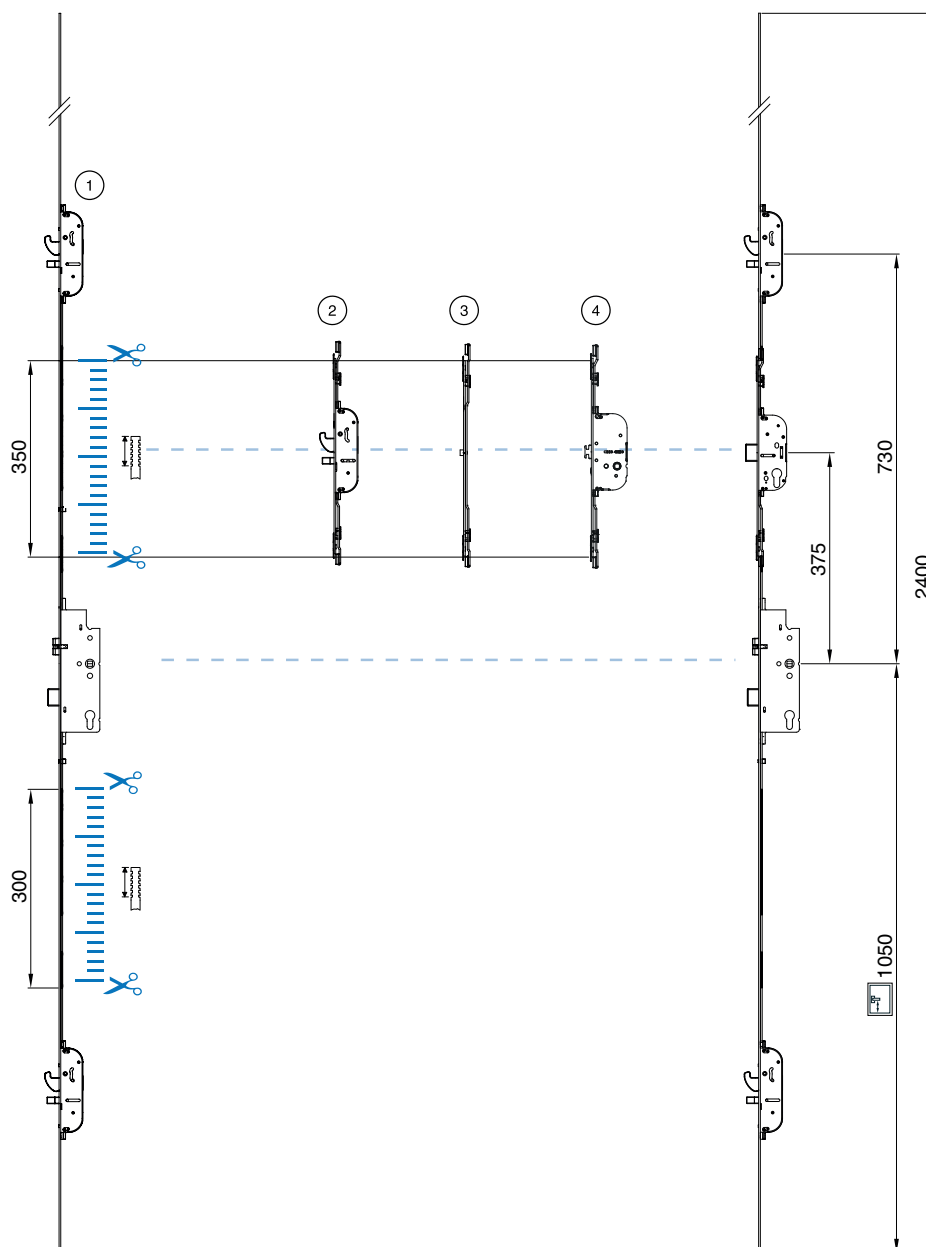

2 ganci-punzoni, 2 ganci, 2 punzoni

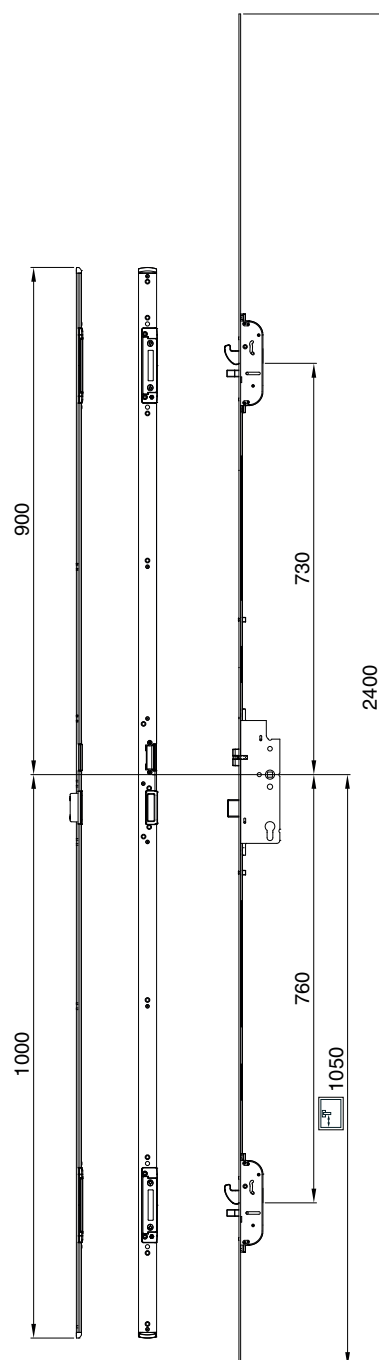
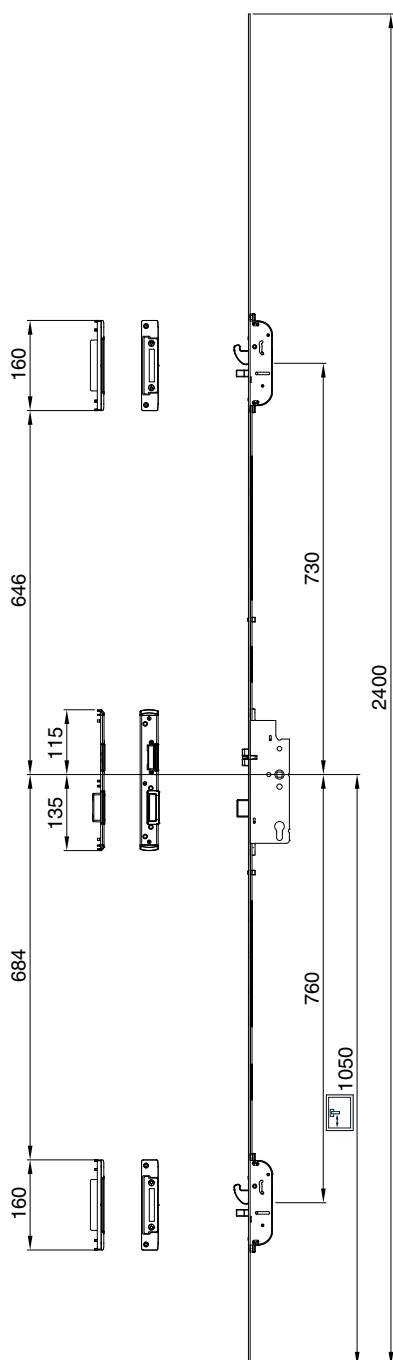

## 5.2 Serratura comando cilindro modulare con funghi



A

### 5.2.1 Serratura comando cilindro modulare I92 con 3 funghi F16



prolungabile	argento	92							L		No
		35	8	1.050	3	1.600 - 1.800	16	1.800	5	A	260360
		40	8	1.050	3	1.600 - 1.800	16	1.800	5		260361
		45	8	1.050	3	1.600 - 1.800	16	1.800	5		260362
		50	8	1.050	3	1.600 - 1.800	16	1.800	5		260363
		55	8	1.050	3	1.600 - 1.800	16	1.800	5		260364
		65	8	1.050	3	1.600 - 1.800	16	1.800	5		260365



A

### 5.2.2 Serratura comando cilindro modulare I92 con 4 funghi F16



prolungabile	argento	92							L		No
		25	8	1.050	4	1.950 - 2.400	16	2.400	5		234180
		30	8	1.050	4	1.950 - 2.400	16	2.400	5		234181
		35	8	1.050	4	1.950 - 2.400	16	2.400	5		230690
		40	8	1.050	4	1.950 - 2.400	16	2.400	5		230691
		45	8	1.050	4	1.950 - 2.400	16	2.400	5		230692
		50	8	1.050	4	1.950 - 2.400	16	2.400	5		230693
		55	8	1.050	4	1.950 - 2.400	16	2.400	5	A	230694
		65	8	1.050	4	1.950 - 2.400	16	2.400	5		230695
		70	8	1.050	4	1.950 - 2.400	16	2.400	5		230696
		80	8	1.050	4	1.950 - 2.400	16	2.400	5		230697



A

### 5.2.3 Serratura comando cilindro modulare I92 con 4 funghi F20



prolungabile	argento	92							L		No
		35	8	1.050	4	1.950 - 2.400	20	2.400	5		230760
		40	8	1.050	4	1.950 - 2.400	20	2.400	5		230761
		45	8	1.050	4	1.950 - 2.400	20	2.400	5		230762
		50	8	1.050	4	1.950 - 2.400	20	2.400	5		230763
		55	8	1.050	4	1.950 - 2.400	20	2.400	5	A	230764
		65	8	1.050	4	1.950 - 2.400	20	2.400	5		230765
		80	8	1.050	4	1.950 - 2.400	20	2.400	5		230767



A









### 5.2.4 Serratura comando cilindro modulare I92 con 4 funghi F24/16











prolungabile	argento	92							L		No
		35	8	1.050	4	1.950 - 2.400	24/16	2.400	5		237600
		40	8	1.050	4	1.950 - 2.400	24/16	2.400	5		237601
		45	8	1.050	4	1.950 - 2.400	24/16	2.400	5		237602
		50	8	1.050	4	1.950 - 2.400	24/16	2.400	5		237603
		55	8	1.050	4	1.950 - 2.400	24/16	2.400	5	A	237604
		65	8	1.050	4	1.950 - 2.400	24/16	2.400	5		237605

### 5.3 Serratura comando cilindro modulare con ganci-punzoni e funghi



5.3.1 Serratura comando cilindro modulare I92 con 2 ganci-punzoni e 1 fungo F16									L		No	
prolungabile	argento	92	35	8	1.050	1	1.950 - 2.400	16	1.800	5	A	<b>260270</b>
			40	8	1.050	1	1.950 - 2.400	16	1.800	5		<b>260271</b>
			45	8	1.050	1	1.950 - 2.400	16	1.800	5		<b>260272</b>
			50	8	1.050	1	1.950 - 2.400	16	1.800	5		<b>260273</b>
			55	8	1.050	1	1.950 - 2.400	16	1.800	5		<b>260274</b>
			65	8	1.050	1	1.950 - 2.400	16	1.800	5		<b>260275</b>



5.3.2 Serratura comando cilindro modulare I92 con 2 ganci-punzoni e 2 funghi F16									L		No	
prolungabile	argento	92	35	8	1.050	2	1.950 - 2.400	16	2.400	5		<b>238560</b>
			40	8	1.050	2	1.950 - 2.400	16	2.400	5		<b>238561</b>
			45	8	1.050	2	1.950 - 2.400	16	2.400	5		<b>238562</b>
			50	8	1.050	2	1.950 - 2.400	16	2.400	5		<b>238563</b>
			55	8	1.050	2	1.950 - 2.400	16	2.400	5	A	<b>238564</b>
			65	8	1.050	2	1.950 - 2.400	16	2.400	5		<b>238565</b>

## 5.4 Serratura comando cilindro modulare con ganci-punzoni



### 5.4.1 Serratura comando cilindro modulare I92 con 2 ganci-punzoni F16



modulare	argento	92						L		No
		35	8	1.050	1.950 - 2.400	16	2.400	5		235810
		40	8	1.050	1.950 - 2.400	16	2.400	5		235811
		45	8	1.050	1.950 - 2.400	16	2.400	5		235812
		50	8	1.050	1.950 - 2.400	16	2.400	5		235813
		55	8	1.050	1.950 - 2.400	16	2.400	5	A	235814
		65	8	1.050	1.950 - 2.400	16	2.400	5		235815
		70	8	1.050	1.950 - 2.400	16	2.400	5		235816
		80	8	1.050	1.950 - 2.400	16	2.400	5		235817



### 5.4.2 Serratura comando cilindro modulare I92 con 2 ganci-punzoni F20



modulare	argento	92						L		No
		45	8	1.050	1.950 - 2.400	20	2.400	5		235852
		50	8	1.050	1.950 - 2.400	20	2.400	5		235853
		55	8	1.050	1.950 - 2.400	20	2.400	5	A	235854
		65	8	1.050	1.950 - 2.400	20	2.400	5		235855
		70	8	1.050	1.950 - 2.400	20	2.400	5		235856
		80	8	1.050	1.950 - 2.400	20	2.400	5		235857



### 5.4.3 Serratura comando cilindro modulare I92 con 2 ganci-punzoni F24



modulare	argento	92						L		No
		35	8	1.050	1.950 - 2.400	24	2.400	5		235890
		40	8	1.050	1.950 - 2.400	24	2.400	5		235891
		45	8	1.050	1.950 - 2.400	24	2.400	5		235892
		50	8	1.050	1.950 - 2.400	24	2.400	5		235893
		55	8	1.050	1.950 - 2.400	24	2.400	5	A	235894









### 5.4.4 Serratura comando cilindro modulare I92 con 2 ganci-punzoni F24/16









modulare	argento	92						L		No
		35	8	1.050	1.950 - 2.400	24/16	2.400	5		237620
		40	8	1.050	1.950 - 2.400	24/16	2.400	5		237621
		45	8	1.050	1.950 - 2.400	24/16	2.400	5		237622
		50	8	1.050	1.950 - 2.400	24/16	2.400	5		237623
		55	8	1.050	1.950 - 2.400	24/16	2.400	5	A	237624
		65	8	1.050	1.950 - 2.400	24/16	2.400	5		237625
		70	8	1.050	1.950 - 2.400	24/16	2.400	5		237626









5.4.5 Serratura comando cilindro modulare I92 con 2 ganci-punzoni U-6x24x6								L		No
modulare	argento	92	35	8	1.050	1.950 - 2.200	24	2.200	5	<b>236600</b>
		40	8	1.050	1.950 - 2.200	24	2.200	5	<b>236601</b>	
		45	8	1.050	1.950 - 2.200	24	2.200	5	<b>236602</b>	
		50	8	1.050	1.950 - 2.200	24	2.200	5	<b>236603</b>	
		55	8	1.050	1.950 - 2.200	24	2.200	5	A <b>236604</b>	



5.4.6 Serratura comando cilindro modulare I92 con 4 ganci-punzoni F16								L		No
modulare	argento	92	35	8	1.050	1.950 - 2.400	16	2.400	5	<b>234000</b>
		40	8	1.050	1.950 - 2.400	16	2.400	5	<b>234001</b>	
		45	8	1.050	1.950 - 2.400	16	2.400	5	<b>234002</b>	
		50	8	1.050	1.950 - 2.400	16	2.400	5	<b>234003</b>	
		55	8	1.050	1.950 - 2.400	16	2.400	5	A <b>234004</b>	







5.4.7 Serratura comando cilindro modulare I92 con 4 ganci-punzoni F20								L		No
modulare	argento	92	45	8	1.050	1.950 - 2.400	20	2.400	5	<b>235122</b>
		50	8	1.050	1.950 - 2.400	20	2.400	5	<b>235123</b>	
		55	8	1.050	1.950 - 2.400	20	2.400	5	A <b>235124</b>	

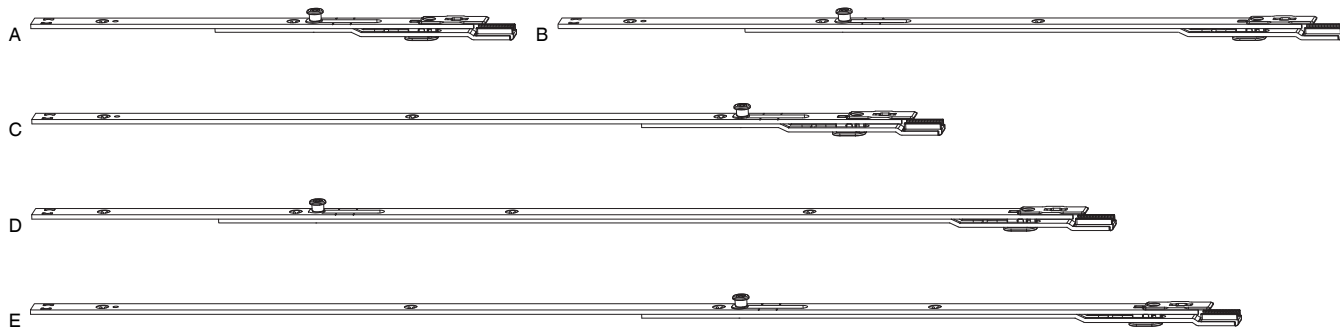



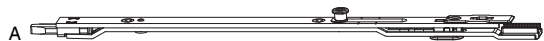

## 5.5 Terminale per serratura comando cilindro e maniglia

### 5.5.1 Terminale









5.5.1.1 Terminale senza puntale					L		No
argento	1.900 - 2.100	16	255	1	300	10	A 57824
		20	255	1	300	10	11243
	2.100 - 2.300	16	255	1	500	10	B 55993
		20	255	1	500	10	11244
	2.185 - 2.385	16	540	1	585	10	C 57825
	2.300 - 2.500	16	255	1	700	10	D 57826
		20	255	1	700	10	101490
	2.385 - 2.585	16	540	1	785	10	E 57827

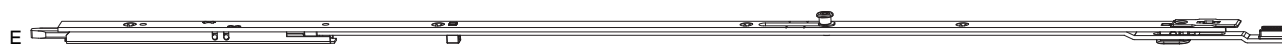

5.5.1.2 Terminale con puntale						L		No
argento	1.900 - 2.100	16	255	9	1	300	10	A 58107

### 5.5.2 Terminale ad inversione





5.5.2.1 Terminale ad inversione con puntale						L			No
argento	1.900 - 2.100	16	255	9	1	300	10	A	<b>200983</b>
	2.100 - 2.300	16	255	9	1	500	10	B	<b>200984</b>
	2.185 - 2.385	16	540	9	1	585	10	C	<b>200985</b>
	2.300 - 2.500	16	255	9	1	700	10	D	<b>200986</b>
	2.385 - 2.585	16	540	9	1	785	10	E	<b>200987</b>
		20	540	9	1	785	10		<b>101488</b>

## 5.6 Accessori per serrature modulari



### 5.6.1 Prolunga per serratura

Prolunga per serratura autobloccante argento



		L		Nº
F	16	250	10	A <b>104785</b>
	20	250	10	<b>104786</b>
	24	250	10	<b>104787</b>
	24 / 16	250	10	<b>104788</b>
U	24	250	10	<b>104789<sup>1</sup></b>

<sup>1</sup> da ordine assieme a due pezzi 373861 per parte superiore e inferiore



### 5.6.2 Giunzione accorciamento serratura



Giunzione accorciamento serratura autobloccante argento

		L		Nº
F	16	50	10	A <b>104790</b>
	20	50	10	<b>104791</b>
	24	50	10	<b>104792</b>
	24 / 16	50	10	<b>104793</b>
U	24	50	10	<b>104794</b>



### 5.6.3 Prolunga con punto di chiusura

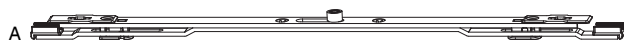

Prolunga con gancio-punzone argento

		L		Nº
F	16	705	5	A <b>212643</b>
	20	705	5	<b>212758</b>
	24	705	5	<b>212762</b>
	24 / 16	705	5	<b>213961</b>
U	24	705	5	<b>215376</b>





### 5.6.4 Componente frontale con contatto magnetico

Componente frontale con contatto magnetico argento

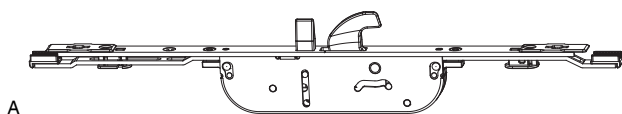
		L		Nº
F	16	350	5	A <b>212646</b>
	20	350	5	<b>212761</b>
	24	350	5	<b>212765</b>
	24 / 16	350	5	<b>213964</b>
U	24	350	5	<b>215380</b>



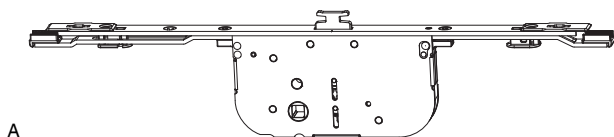

**5.6.5 Componente frontale con gancio-punzone**

			L			Nº
Componente frontale con gancio-punzone argento	F	16	350	5	A	<b>212644</b>
		20	350	5		<b>212759</b>
		24/16	350	5		<b>213962</b>
	U	24	350	5	<b>215377</b>	



**5.6.6 Componente frontale con delimitatore d'apertura**

				L			Nº
Componente frontale con delimitatore d'apertura argento	F	16	E 35	350	5	A	<b>213046</b>
			E 45	350	5		<b>213048</b>
			E 50	350	5		<b>213049</b>
			E 55	350	5		<b>213050</b>
			E 65	350	5		<b>213051</b>
	20	E 45	350	5	<b>213056</b>		
		E 50	350	5	<b>213057</b>		
		E 55	350	5	<b>213058</b>		
	24	E 65	350	5	<b>213059</b>		
		E 55	350	5	<b>213066</b>		
	U	24	E 35	350	5	<b>215381</b>	
			E 45	350	5	<b>215382</b>	



## **6 Serratura comando maniglia prolungabile (G-TS)**

---

<b>6.1</b>	<b>Composizione ferramenta serratura comando maniglia</b>	<b>58</b>
<b>6.2</b>	<b>Serratura comando maniglia prolungabile con funghi</b>	<b>59</b>
6.2.1	Serratura comando maniglia prolungabile con 4 funghi	59

## 6 Serratura comando maniglia prolungabile (G-TS)

### 6.1 Composizione ferramenta serratura comando maniglia

4 funghi

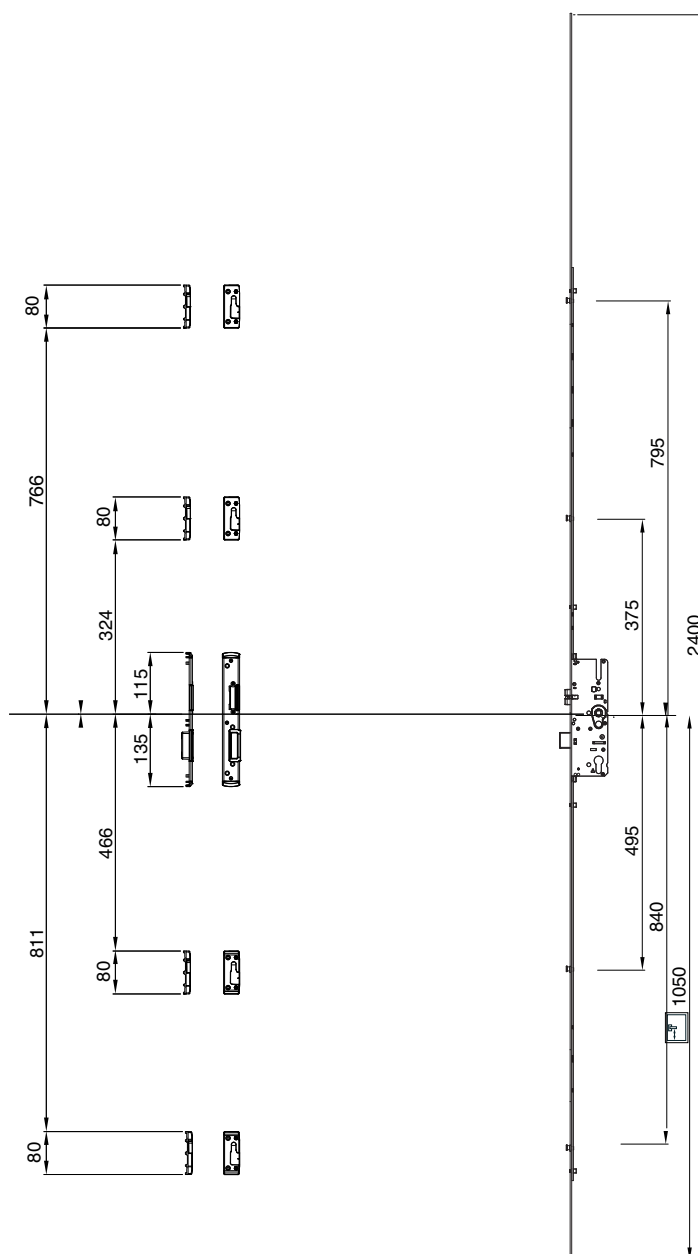

## 6.2 Serratura comando maniglia prolungabile con funghi

### 6.2.1 Serratura comando maniglia prolungabile con 4 funghi



A

6.2.1.1 Serratura comando maniglia I92 con 4 funghi F16									<b>L</b>		<b>No</b>
prolungabile	argento	92	28	8	1.050	4	1.950 - 2.200	16	2.200	5	<b>232010</b>
		35	8	1.050	4	1.950 - 2.200	16	2.200	5	<b>232011</b>	
		40	8	1.050	4	1.950 - 2.200	16	2.200	5	<b>232012</b>	
		45	8	1.050	4	1.950 - 2.200	16	2.200	5	<b>232013</b>	
		50	8	1.050	4	1.950 - 2.200	16	2.200	5	<b>232014</b>	
		55	8	1.050	4	1.950 - 2.200	16	2.200	5	A <b>232015</b>	
		65	8	1.050	4	1.950 - 2.200	16	2.200	5	<b>232017</b>	



Serratura comando maniglia  
prolungabile (G-TS)

## 7 Serratura per portafinestra (B-TV)

---

<b>7.1</b>	<b>Composizione serratura per portafinestra</b>	<b>62</b>
<b>7.2</b>	<b>Serrature per portafinestra Multi Matic I92</b>	<b>63</b>
<b>7.3</b>	<b>Accessori per serratura portafinestra Multi Matic</b>	<b>64</b>
7.3.1	Prolunga frontale per serratura portafinestra Multi Matic	64
7.3.2	Movimento angolare per serratura portafinestra	64
7.3.3	Terminale superiore con fungo	64
7.3.4	Terminale superiore con fungo e puntale	64
7.3.5	Terminale inferiore senza nottolino con puntale	64





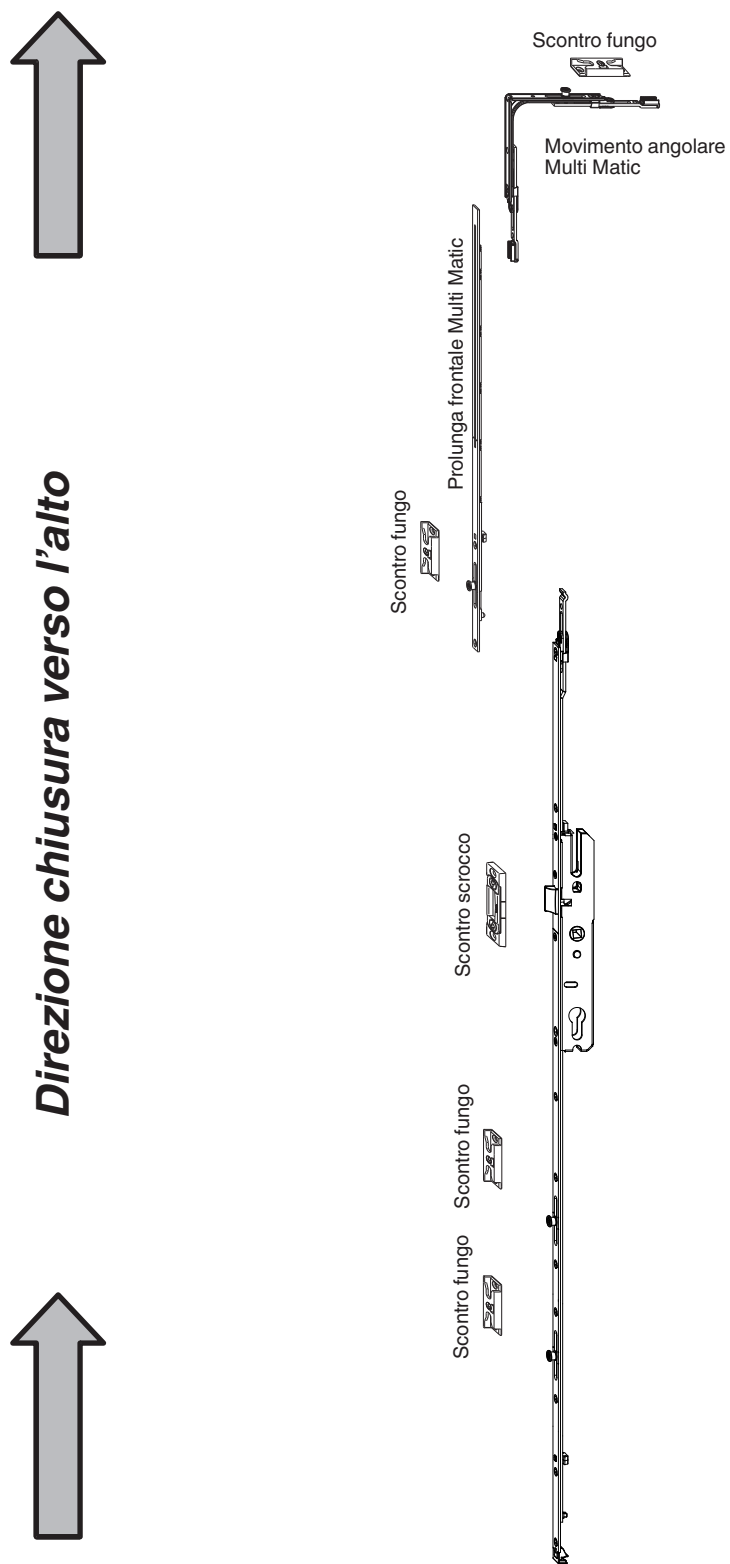

7 Serratura per portafinestra (B-TV)

7.1 Composizione serratura per portafinestra



 *Combinazione possibile con ferramenta per finestre MULTI-MATIC*



7.2 Serrature per portafinestra Multi Matic I92							<b>L</b>		<b>Nº</b>
MM fix	argento	25	8	1.050	2	92	1.347	5	<b>203828<sup>1</sup></b>
		28	8	1.050	2	92	1.347	5	<b>203696<sup>1</sup></b>
		35	8	1.050	2	92	1.347	5	<b>203829<sup>1</sup></b>
		40	8	1.050	2	92	1.347	5	<b>203830<sup>1</sup></b>
		45	8	1.050	2	92	1.347	5	<b>203831<sup>1</sup></b>
		50	8	1.050	2	92	1.347	5	<b>203832<sup>1</sup></b>
		55	8	1.050	2	92	1.347	5	<b>203833<sup>1</sup></b>

<sup>1</sup> Prolunghe frontali nel capitolo accessori

### 7.3 Accessori per serratura portafinestra Multi Matic



#### 7.3.1 Prolunga frontale per serratura portafinestra Multi Matic



**Nº**

Prolunga frontale per portabalcone Multi Matic 1950 con 1 fungo argento	10	A	<b>203697</b>
Prolunga frontale per portabalcone Multi Matic 2200 con 1 fungo argento	10		<b>203698</b>
Prolunga frontale per portabalcone Multi Matic 2450 con 2 funghi argento	10		<b>203699</b>

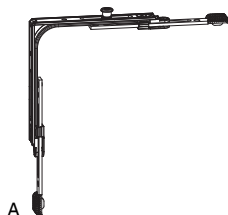

#### 7.3.2 Movimento angolare per serratura portafinestra



**Nº**

Movimento angolare MM IQ con 1 fungo LBB 320-1.800 HBB 360-2.800 argento	50	A	<b>222201</b>
--	----	---	---------------



#### 7.3.3 Terminale superiore con fungo



**L**



**Nº**

argento	1	113,5	20	A	<b>212687</b>
---------	---	-------	----	---	---------------



#### 7.3.4 Terminale superiore con fungo e puntale



**L**



**Nº**

argento	431 - 2.450	8	80	100	A	<b>214013</b>
				100	B	<b>214014</b>
dx	431 - 2.450	8	80	100	C	<b>218977</b>
sx	431 - 2.450	8	80	100	D	<b>218978</b>
	431 - 2.450	8	113,5	20	E	<b>208432</b>
				20	F	<b>214016</b>



#### 7.3.5 Terminale inferiore senza nottolino con puntale



**L**



**Nº**

argento	500 - 2.350	170	20	A	<b>225092</b>
---------	-------------	-----	----	---	---------------

## 8 Scontri

---

<b>8.1</b>	<b>Scontri legno</b>	<b>66</b>
8.1.1	Scontri A4 scostamento 9mm	66
8.1.2	Scontri A4 scostamento 10mm	68
8.1.3	Scontri A4 scostamento 13mm	69
8.1.4	Scontri A12 scostamento 9 mm	71
8.1.5	Scontri A12 scostamento 10 mm	73
8.1.6	Scontri A12 scostamento 13 mm	74
<b>8.2</b>	<b>Scontri cava ferramenta contrapposta</b>	<b>76</b>
8.2.1	Scontri per scrocco-mandata	76
8.2.2	Scontri per nottolino	76
8.2.3	Scontri per fungo	76
8.2.4	Scontri per gancio-punzone	76
8.2.5	Scontri per scrocco	76
8.2.6	Scontri per scrocco portafinestra	76
<b>8.3</b>	<b>Asta scontri legno</b>	<b>77</b>
8.3.1	Asta Scontri legno U-6x24x6 scostamento 13mm	77
<b>8.4</b>	<b>Scontri e asta scontri PVC</b>	<b>78</b>
8.4.1	Scontri e aste scontri per serratura autobloccante	78
8.4.2	Scontri e aste scontri per serratura comando cilindro modulare/automatica	79
<b>8.5</b>	<b>Scontri Alu</b>	<b>80</b>
8.5.1	Scontri Alu 3 mm battuta liscia scost. 13	80
8.5.2	Scontri Alu 3 mm scost.10 canalino 14mm	81
8.5.3	Scontri Alu U-6/24/6 scost. 13	82
8.5.4	Scontri Alu scost.9 canalino 14 mm	83
8.5.5	Scontri Alu scost.13 canalino 14 mm	84

## 8 Scontri

### 8.1 Scontri legno

#### 8.1.1 Scontri A4 scostamento 9mm





8.1.1.1 Scontri per scrocco-mandata			L	B	H		No
argento	destro	Scontro scrocco-mandata per serratura autobloccante A4 scost.9 mm	220	18	8	20	<b>219231</b>
	sinistro	Scontro scrocco-mandata per serratura autobloccante A4 scost.9 mm	220	18	8	20	A <b>219232</b>
		Scontro scrocco-mandata A4 scost.9 mm	208	18	8	50	B <b>29776<sup>1,2</sup></b>

<sup>1</sup> Utilizzabile con coprifresata 43524

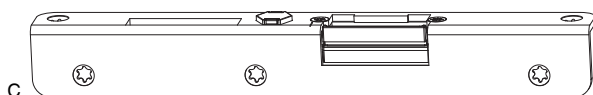
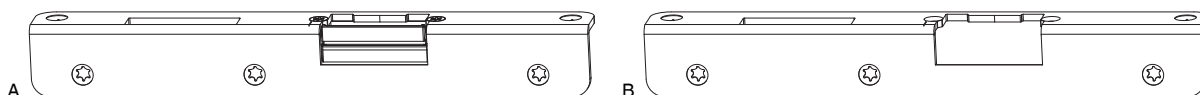
<sup>2</sup> Utilizzabile con terminale 43718 per legno A12



8.1.1.2 Scontri ad angolo scrocco mandata			L			No
argento	destro	Scontro scrocco-mandata ad angolo con inserto A4 scost.9 mm	250	32 x 25	20	<b>203502</b>
		Scontro scrocco-mandata ad angolo per apriporta elettrico A4 scost.9 mm	250	32 x 25	20	<b>354952</b>
		Scontro scrocco-mandata ad angolo per apriporta elettrico A4 scost.9 mm pressione -1 mm	250	15 x 25	20	<b>360112</b>
		Scontro scrocco-mandata ad angolo per serratura autobloccante A4 scost.9 mm	250	32 x 25	20	<b>218903</b>
	sinistro	Scontro scrocco-mandata ad angolo con inserto A4 scost.9 mm	250	32 x 25	20	A <b>203503</b>
		Scontro scrocco-mandata ad angolo per apriporta elettrico A4 scost.9 mm	250	32 x 25	20	B <b>354954</b>
		Scontro scrocco-mandata ad angolo per apriporta elettrico A4 scost.9 mm pressione -1 mm	250	15 x 25	20	<b>360113</b>
		Scontro scrocco-mandata ad angolo per serratura autobloccante A4 scost.9 mm	250	32 x 25	20	C <b>218904</b>



8.1.1.3 Scontri per nottolino A4			L	B	H		No
argento		Scontro nottolino per A4 scost. 9 mm	90	18	8	200	A <b>30545</b>



8.1.1.4 Scontri per fungo A4			L	B	H		No
argento	destro	Scontro fungo per A4 scost. 9 mm pressione - 1 mm	90	18	8	100	<b>96305<sup>1,2</sup></b>
		Scontro fungo per A4 scost. 9 mm con vite inclinata	90	18	8	100	<b>96565<sup>1</sup></b>
	sinistro	Scontro fungo per A4 scost. 9 mm pressione - 1 mm	90	18	8	100	<b>96306<sup>1,2</sup></b>
		Scontro fungo per A4 scost. 9 mm con vite inclinata	90	18	8	100	A <b>96566<sup>1</sup></b>

<sup>1</sup> Per porte destre usare scontri sinistri e viceversa!

<sup>2</sup> Senza conformità con la norma EN 1627



8.1.1.5 Scontri per gancio-punzone		L	B	H		Nº
argento	Scontro gancio-punzone A4 scost.9 mm	180	18	8	20	A 207862 <sup>1,2</sup>

<sup>1</sup> Utilizzabile con coprifresata 358024



<sup>2</sup> Utilizzabile con terminale 43718 per legno A12

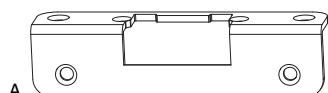

8.1.1.6 Scontri per scrocco		L	B	H		Nº
argento	Scontro scrocco per serratura automatica A4 scost.9 mm	120	18	8	20	A 210501 <sup>1</sup>

<sup>1</sup> Utilizzabile con terminale 360074 per A12





8.1.1.7 Scontri ad angolo per scrocco		L			Nº
argento	Scontro scrocco per scrocco elettrico A4 scost.9 mm	130	32 x 25	20	A 362002

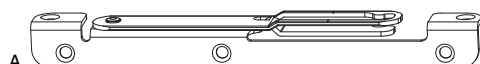

8.1.1.8 Scontri per scrocco portafinestra		L	B	H		Nº
argento	Scontro scrocco cremonese portafinestra A4 scost.9 mm regolabile	90	18	8	50	A 94118 <sup>1</sup>

<sup>1</sup> Utilizzabile con terminale 43718 per legno A12



8.1.1.9 Scontri per delimitatore d'apertura		L			Nº
argento	destro Scontro per delimitatore d'apertura A4 scost.9 mm	200	20 x 18	20	212936
	sinistro Scontro per delimitatore d'apertura A4 scost.9 mm	200	20 x 18	20	A 212937



8.1.1.10 Scontri catenaccio puntale 10x5		L	B	H		Nº
argento	Scontro punzone A4 scost.9 mm	120	18	8	20	A 26799 <sup>1</sup>
	Scontro catenaccio 2 fori A4 scost.9 mm	120	18	8	20	B 50576

<sup>1</sup> Utilizzabile con coprifresata 41250



8.1.1.11 Scontri catenaccio puntale 8x4		L	B	H		Nº
argento	Scontro catenaccio per A4 scost. 9 mm 2 fori	90	18	8	100	A 23883 <sup>1</sup>
	Scontro catenaccio per A4 scost. 9 mm 1 foro registrabile	90	18	8	100	B 55112 <sup>1</sup>

<sup>1</sup> Utilizzabile con terminale 43718 per legno A12

### 8.1.2 Scontri A4 scostamento 10mm



8.1.2.1 Scontri per scrocco-mandata			L	B	H		Nº
argento	destro	Scontro scrocco-mandata per serratura autobloccante A4 scost.10 mm	220	20	8	20	<b>219235</b>
	sinistro	Scontro scrocco-mandata per serratura autobloccante A4 scost.10 mm	220	20	8	20	A <b>219236</b>
		Scontro scrocco-mandata A4 scost.10 mm	208	20	8	50	B <b>29787<sup>1,2</sup></b>

<sup>1</sup> Utilizzabile con terminale 354358 per aria 12 mm

<sup>2</sup> Utilizzabile con coprifresata 43524



8.1.2.2 Scontri per nottolino A4			L	B	H		Nº
argento		Scontro nottolino A4 scost.9 mm con vite inclinata	90	20	8	50	A <b>34004<sup>1</sup></b>

<sup>1</sup> Utilizzabile con terminale 354358 per aria 12 mm



8.1.2.3 Scontri per fungo A4			L	B	H		Nº
argento	destro	Scontro fungo A4 scost.10 mm con vite inclinata	90	20	8	100	<b>96845<sup>1</sup></b>
	sinistro	Scontro fungo A4 scost.10 mm con vite inclinata	90	20	8	100	A <b>96846<sup>1</sup></b>

<sup>1</sup> Per porte destre usare scontri sinistri e viceversa!



8.1.2.4 Scontri per gancio-punzone			L	B	H		Nº
argento	dx+sx	Scontro gancio-punzone A4 scost.10 mm	180	20	8	20	A <b>207861<sup>1,2</sup></b>

<sup>1</sup> Utilizzabile con coprifresata 358024



<sup>2</sup> Utilizzabile con terminale 354358 per aria 12 mm

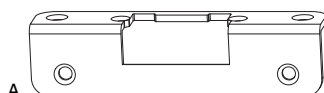

8.1.2.5 Scontri per scrocco			L	B	H		Nº
argento		Scontro scrocco A4 scost.10 mm	120	20	8	20	A <b>210502<sup>1</sup></b>

<sup>1</sup> Utilizzabile con terminale 354358 per aria 12 mm



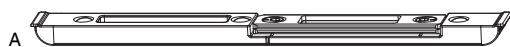

8.1.2.6 Scontri ad angolo per scrocco			L		H		Nº
Scontro scrocco per scrocco elettrico A4 scost.9 mm argento			130	a b	20	A	<b>362002</b>

### 8.1.3 Scontri A4 scostamento 13mm

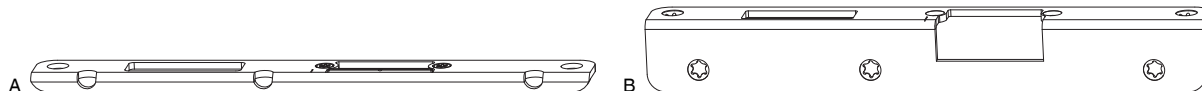

8.1.3.1 Scontri per scrocco-mandata			L	B	H		Nº
argento	destro	Scontro scrocco-mandata A4 scost.13 mm	208	22	8	50	<b>209907</b>
	sinistro	Scontro scrocco-mandata A4 scost.13 mm	208	22	8	50	A <b>209908</b>



8.1.3.2 Scontri ad angolo-scrocco mandata			L	a	b		Nº
argento	destro	Scontro scrocco-mandata ad angolo per serratura autobloccante A4 scost.13 mm	250	8 x 30	20		<b>226810<sup>1</sup></b>
		Scontri ad angolo scrocco-mandata A4 scost.13 mm	250	8 x 24	20		<b>214455<sup>2,3</sup></b>
		Scontro scrocco-mandata ad angolo per serratura autobloccante A4 scost.13 mm	250	8 x 24	20		<b>218901<sup>2,3</sup></b>
	sinistro	Scontro scrocco-mandata ad angolo per apriporta elettrico A4 scost.13 mm	250	32 x 25	20		<b>360614</b>
		Scontro scrocco-mandata ad angolo per serratura autobloccante A4 scost.13 mm	250	8 x 30	20		<b>226811<sup>1</sup></b>
		Scontri ad angolo scrocco-mandata A4 scost.13 mm	250	8 x 24	20	A	<b>214456<sup>2,3</sup></b>
		Scontro scrocco-mandata ad angolo per serratura autobloccante A4 scost.13 mm	250	8 x 24	20		<b>218902<sup>2,3</sup></b>
	Scontro scrocco-mandata ad angolo per apriporta elettrico A4 scost.13 mm	250	32 x 25	20	B	<b>360615</b>	

<sup>1</sup> Utilizzabile con terminale 369691 per A12.

<sup>2</sup> Utilizzabile con coprifresata 372926

<sup>3</sup> Utilizzabile con terminale 362920 per A12.



8.1.3.3 Scontri per nottolino A4			L	B	H		Nº
argento	destro	Scontro nottolino per A4 scost. 13 mm pressione - 1 mm	90	22	8	200	<b>357671</b>
	sinistro	Scontro nottolino per A4 scost. 13 mm pressione - 1 mm	90	22	8	200	A <b>357672</b>



8.1.3.4 Scontri per fungo A4			L	B	H		Nº
argento	destro	Scontro fungo per A4 scost. 13 mm con vite inclinata	90	22	8	100	<b>357673<sup>1</sup></b>
		Scontro fungo per A4 scost. 13 mm con vite inclinata pressione - 1 mm	90	22	8	100	<b>360102<sup>1,2</sup></b>
	sinistro	Scontro fungo per A4 scost. 13 mm con vite inclinata	90	22	8	100	<b>357674<sup>1</sup></b>
		Scontro fungo per A4 scost. 13 mm con vite inclinata pressione - 1 mm	90	22	8	100	A <b>360103<sup>1,2</sup></b>

<sup>1</sup> Per porte destre usare scontri sinistri e viceversa!

<sup>2</sup> Senza conformità con la norma EN 1627



8.1.3.5 Scontri per gancio-punzone			L	B	H		Nº
argento		Scontro gancio-punzone A4 scost.13 mm	180	22	8	20	A <b>209909<sup>1</sup></b>

<sup>1</sup> Utilizzabile con coprifresata 358024

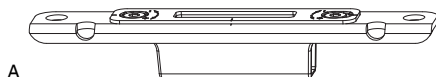

A

**8.1.3.6 Scontri ad angolo per gancio-punzone**

		L	a	b		N <sup>o</sup>
argento	Scontro scrocco-gancio A4 scost. 13 mm	180	8 x 30	20		227065 <sup>1</sup>
			8 x 24	20	A	214459 <sup>2</sup>

<sup>1</sup> Utilizzabile con terminale 369691 per A12.

<sup>2</sup> Utilizzabile con terminale 362920 per A12.



A

**8.1.3.7 Scontri per scrocco**

		L	B	H		N <sup>o</sup>
argento	Scontro scrocco A4 scost. 13 mm	180	22	8	20	A 211597



A

**8.1.3.8 Scontri ad angolo per scrocco**

		L	a	b		N <sup>o</sup>
argento	Scontro per scrocco elettrico A4 scost. 13 mm	130	8 x 24	20	A	214458 <sup>1</sup>

<sup>1</sup> Utilizzabile con terminale 362920 per A12.

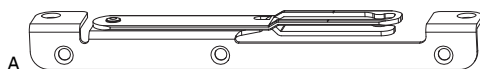

A

**8.1.3.9 Scontri per delimitatore d'apertura**

		L	a	b		N <sup>o</sup>
argento	destro Scontro per delimitatore d'apertura A4 scost. 13 mm	200	20 x 24	20		216863
	sinistro Scontro per delimitatore d'apertura A4 scost. 13 mm	200	20 x 24	20	A	216864



A

B

**8.1.3.10 Scontri catenaccio puntale 10x5**

		L	B	H		N <sup>o</sup>
argento	Scontro punzone A4 scost. 13 mm	180	22	8	20	A 209911
	Scontro catenaccio 2 fori A4 scost. 13 mm	180	22	8	20	B 209912

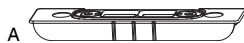



A

**8.1.3.11 Scontri catenaccio puntale 8x4**

		L	B	H		N <sup>o</sup>
argento	Scontro catenaccio per A4 scost. 13 mm 2 fori	90	22	9	100	A 209338

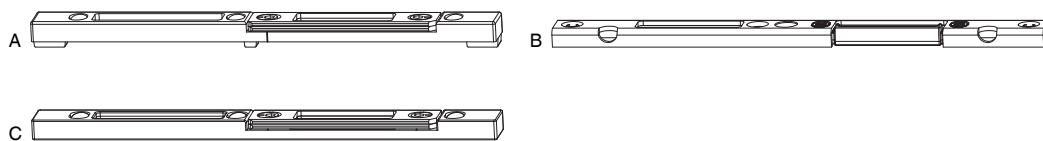

### 8.1.4 Scontri A12 scostamento 9 mm

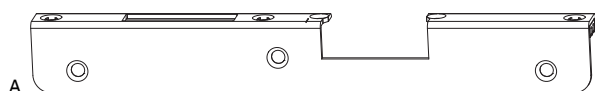

8.1.4.1 Scontri per scrocco-mandata			L	B	H		Nº
argento	destro	Scontro scrocco-mandata per canalino euro 6/8x4	208	18	9	50	<b>58646<sup>1</sup></b>
		Scontro scrocco-mandata per canalino euro 7/8x4	208	18	9	50	<b>58648<sup>1</sup></b>
		Scontro scrocco-mandata per serratura autobloccante A12 scost.9	220	18	8	20	<b>219233</b>
	sinistro	Scontro scrocco-mandata per canalino euro 6/8x4	208	18	9	50	<b>58647<sup>1</sup></b>
		Scontro scrocco-mandata per canalino euro 7/8x4	208	18	9	20	<b>A 58649<sup>1</sup></b>
		Scontro scrocco-mandata per serratura autobloccante A12 scost.9	220	18	8	20	<b>B 219234</b>
		Scontro scrocco-mandata battuta liscia/18	208	18	9	50	<b>C 55987<sup>1</sup></b>

<sup>1</sup> Utilizzabile con coprifresata 43524



8.1.4.2 Scontri ad angolo scrocco-mandata			L			Nº
argento	destro	Scontro scrocco-mandata ad angolo per apriporta elettrico battuta liscia/18	250	32 x 18	20	<b>210813</b>
	sinistro	Scontro scrocco-mandata ad angolo per apriporta elettrico battuta liscia/18	250	32 x 18	20	<b>A 210814</b>

8.1.4.3 Scontri a U scrocco-mandata per apriporta elettrico			L	B		Nº
argento	destro	Scontro scrocco-mandata per apriporta elettrico battuta liscia	245	22	1	<b>K702501<sup>1</sup></b>
	sinistro	Scontro scrocco-mandata per apriporta elettrico battuta liscia	245	22	1	<b>K702505<sup>1</sup></b>

<sup>1</sup> Prodotto commercializzato da MACO. Il produttore di questo articolo® è elencato alla voce "Prodotti commercializzati" nelle "Norme sulla responsabilità del produttore". Per questo prodotto valgono tutte le specifiche tecniche, le note, le istruzioni e le linee guida del produttore, nonché esclusivamente le sue garanzie.



8.1.4.4 Scontri per nottolino			L	B	H		Nº
argento		Scontro nottolino per canalino euro 7/8x4 pressione - 1 mm	48	16	8	200	<b>A 34969</b>
		Scontro nottolino per canalino euro 6/8x4 pressione - 1 mm	48	16	8	200	<b>34979</b>
		Scontro nottolino battuta liscia/18 con vite inclinata	48	17	9	200	<b>B 34980</b>
		Scontro nottolino battuta liscia/18 2 fori vite	49	17	9	200	<b>C 34943</b>



8.1.4.5 Scontri per fungo			L	B	H		Nº
argento		Scontro fungo battuta liscia/18 con vite inclinata pressione -0,7 mm	68	18	9	100	<b>A 96660</b>
		Scontro fungo battuta liscia/18 con vite inclinata	68	18	9	100	<b>96860</b>
		Scontro fungo per canalino euro 6/8x4 con vite inclinata	68	18	9	100	<b>B 96563</b>
		Scontro fungo per canalino euro 7/8x4 con vite inclinata	68	18	9	100	<b>96564</b>
		Scontro fungo per canalino euro 7/8x4 con vite inclinata pressione - 1 mm	68	18	9	100	<b>96264</b>



8.1.4.6 Scontri per gancio-punzone		L	B	H		N <sup>o</sup>
argento	Scontro gancio-punzone A4 scost.9 mm	180	18	8	20	A 207862 <sup>1,2</sup>

<sup>1</sup> Deve essere utilizzato con terminale 43718!



<sup>2</sup> Utilizzabile con coprifresata 358024

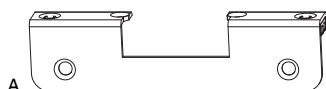

8.1.4.7 Scontri per scrocco		L	B	H		N <sup>o</sup>
argento	Scontro scrocco per serratura automatica A4 scost.9 mm	120	18	8	20	A 210501 <sup>1</sup>

<sup>1</sup> Deve essere utilizzato con terminale 360074!





8.1.4.8 Scontri ad angolo per scrocco		L			N <sup>o</sup>
argento	Scontro ad angolo per scrocco elettrico battuta liscia/18	130	32 x 18	20	A 213325

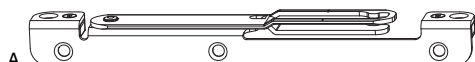

8.1.4.9 Scontri per scrocco portafinestra		L	B	H		N <sup>o</sup>
argento	Scontro scrocco cremonese portafinestra battuta liscia/18 regolabile	80	17	6,5	50	A 38924
	Scontro scrocco cremonese portafinestra per canalino euro 7/8x4 regolabile	80	17	6,5	50	B 55252
	Scontro scrocco cremonese portafinestra per canalino euro 6/8x4 regolabile	80	17	6,5	50	C 94322



8.1.4.10 Scontri per delimitatore d'apertura		L			N <sup>o</sup>
argento	destro Scontro per delimitatore d'apertura A12 scost.9	200	20 x 18	20	A 212940
	sinistro Scontro per delimitatore d'apertura A12 scost.9	200	20 x 18	20	A 212941





8.1.4.11 Scontri catenaccio puntale 10x5		L	B	H		N <sup>o</sup>
argento	Scontro punzone per canalino euro 7/8x4	84	18	8	20	A 26617
	Scontro punzone battuta liscia/18	84	18	8	20	B 58667
	Scontro catenaccio 2 fori battuta liscia/18	120	18	8	20	C 55986
	Scontro catenaccio 2 fori per canalino euro 7/8x4	120	18	8	20	D 50579

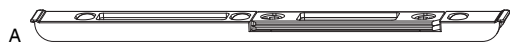

8.1.4.12 Scontri catenaccio puntale 8x4		L	B	H		N <sup>o</sup>
argento	Scontro catenaccio battuta liscia/18 2 fori	80	17	6,5	100	A 23731
	Scontro catenaccio canalino Euro 2 fori	80	17	6,5	100	B 23886
	Scontro catenaccio battuta liscia/18 2 fori	80	17	7,5	100	C 26755

### 8.1.5 Scontri A12 scostamento 10 mm



8.1.5.1 Scontri per scrocco-mandata		L	B	H		Nº
argento	Scontro scrocco-mandata A4 scost.10 mm	208	20	8	50	A <b>29787<sup>1,2</sup></b>

<sup>1</sup> Deve essere utilizzato con terminale 354358!

<sup>2</sup> Utilizzabile con coprifresata 43524



8.1.5.2 Scontri per nottolino		L	B	H		Nº
argento	Scontro nottolino battuta liscia/20 con vite inclinata	48	19	9	200	A <b>34981</b>



8.1.5.3 Scontri per fungo		L	B	H		Nº
argento	Scontro fungo battuta liscia/20 con vite inclinata	68	20	9	100	A <b>96861</b>
	pressione -0,7 mm					
	Scontro fungo battuta liscia/20 con vite inclinata	68	20	9	100	<b>96561</b>



8.1.5.4 Scontri per gancio-punzone		L	B	H		Nº
argento	dx+sx Scontro gancio-punzone A4 scost.10 mm	180	20	8	20	A <b>207861<sup>1,2</sup></b>

<sup>1</sup> Deve essere utilizzato con terminale 354358!

<sup>2</sup> Utilizzabile con coprifresata 358024



8.1.5.5 Scontri per scrocco		L	B	H		Nº
argento	Scontro scrocco A4 scost.10 mm	120	20	8	20	A <b>210502<sup>1</sup></b>

<sup>1</sup> Deve essere utilizzato con terminale 354358!



### 8.1.6 Scontri A12 scostamento 13 mm

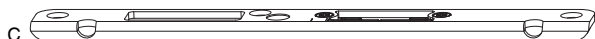
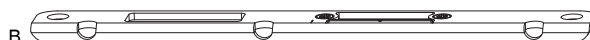
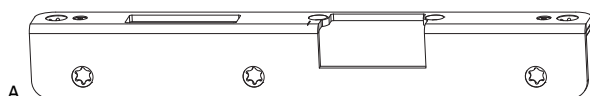

8.1.6.1 Scontri per scrocco-mandata			L	B	H		Nº
argento	destro	Scontro scrocco-mandata legno A12/PB24-sc.13	208	23	9	50	209809 <sup>1</sup>
	sinistro	Scontro scrocco-mandata legno A12/PB24-sc.13	208	23	9	50	A 209810 <sup>1</sup>

<sup>1</sup> Utilizzabile con coprifresata 43524



8.1.6.2 Scontri ad angolo scrocco-mandata			L			Nº
argento	destro	Scontro scrocco-mandata ad angolo per serratura autobloccante A4 scost.13 mm	250	8 x 30	20	226810 <sup>1,2</sup>
		Scontro scrocco-mandata ad angolo per apriporta elettrico legno A12/PB24-sc.13	250	33 x 24	20	210016
	sinistro	Scontri ad angolo scrocco-mandata A4 scost.13 mm	250	8 x 24	20	214455 <sup>1,3</sup>
		Scontro scrocco-mandata ad angolo per serratura autobloccante A4 scost.13 mm	250	8 x 24	20	218901 <sup>1,3</sup>
argento	sinistro	Scontro scrocco-mandata ad angolo per serratura autobloccante A4 scost.13 mm	250	8 x 30	20	226811 <sup>1,2</sup>
		Scontro scrocco-mandata ad angolo per apriporta elettrico legno A12/PB24-sc.13	250	33 x 24	20	A 210017
	sinistro	Scontri ad angolo scrocco-mandata A4 scost.13 mm	250	8 x 24	20	B 214456 <sup>1,3</sup>
		Scontro scrocco-mandata ad angolo per serratura autobloccante A4 scost.13 mm	250	8 x 24	20	C 218902 <sup>1,3</sup>

<sup>1</sup> Utilizzabile con coprifresata 372926

<sup>2</sup> Deve essere usato con terminale in plastica (369691)!

<sup>3</sup> Deve essere utilizzato con terminale 362920!



8.1.6.3 Scontri per nottolino			L	B	H		Nº
argento	Scontro nottolino PB 24 mm scost. 13 mm con vite inclinata		48	23	9	200	A 34934



8.1.6.4 Scontri per fungo			L	B	H		Nº
argento	Scontro fungo PB 24 mm scost. 13 mm senza anello di rinforzo con vite inclinata		68	23	9	100	364952
	Scontro fungo PB 24 mm scost. 13 mm senza anello di rinforzo con vite inclinata pressione - 1 mm		68	23	9	100	A 364953



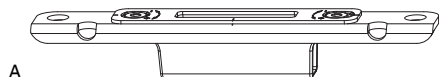

8.1.6.5 Scontri per gancio-punzione			L	B	H		Nº
argento	Scontro gancio-punzione legno A12/PB24-sc.13		180	23	8	20	A 210779 <sup>1</sup>

<sup>1</sup> Utilizzabile con coprifresata 358024



A

8.1.6.6 Scontri ad angolo per gancio-punzone		L	a	b		Nº
argento	Scontro scrocco-gancio A4 scost. 13 mm	180	8 x 30	20		227065 <sup>1</sup>
			8 x 24	20		A 214459 <sup>2</sup>

<sup>1</sup> Deve essere usato con terminale in plastica (369691)!

<sup>2</sup> Deve essere utilizzato con terminale 362920!





A

8.1.6.7 Scontri per scrocco		L	B	H		Nº
argento	Scontro scrocco per serratura automatica legno A12/ PB24-sc. 13	180	23	8	20	A 211598



A

8.1.6.8 Scontri ad angolo per scrocco		L	a	b		Nº
argento	Scontro per scrocco elettrico A4 scost. 13 mm	130	8 x 24	20		A 214458 <sup>1</sup>

<sup>1</sup> Utilizzabile con terminale 362920 per A12.



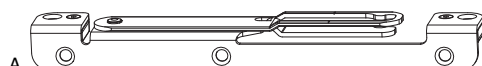

A

8.1.6.9 Scontri per scrocco portafinestra		L	B	H		Nº
argento	Scontro scrocco cremonese portafinestra legno A12/ PB24-sc. 13 regolabile	80	23	6,5	50	A 209347



A

8.1.6.10 Scontri per delimitatore d'apertura		L	a	b		Nº
argento	destro	200	20 x 24	20		216865
	sinistro					Scontro per delimitatore d'apertura legno A12/PB24-sc. 13



A

B

8.1.6.11 Scontri catenaccio puntale 10x5		L	B	H		Nº
argento	Scontro catenaccio 2 fori per A12 scost. 13 mm	180	23	8	20	A 210782
	Scontro punzone PB 24 mm scost. 13 mm	180	23	8	20	B 210781



A

B

C

8.1.6.12 Scontri catenaccio puntale 8x4		L	B	H		Nº
argento	Scontro catenaccio PB 24 mm scost. 13 mm 2 fori	80	23	6,5	100	A 203329
	Scontro catenaccio PB 24 mm scost. 13 mm 2 fori avvitamento inclinato pressione + 1 mm	80	23	6,5	100	B 211369
	Scontro catenaccio PB 24 mm scost. 13 mm 2 fori avvitamento inclinato	80	23	7,7	100	C 212474

## 8.2 Scontri cava ferramenta contrapposta

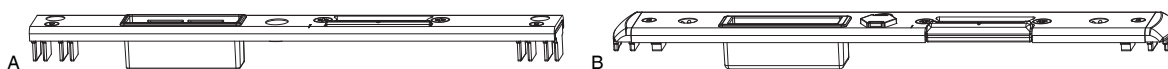

8.2.1 Scontri per scrocco-mandata			L	B	H		N <sup>o</sup>	
argento	destro	Scontro scrocco-mandata cava ferramenta contrapposta	175	18	9	50		<b>58674</b>
		Scontro scrocco-mandata cava ferramenta contrapposta pressione - 1 mm	175	18	9	50		<b>58714</b>
		Scontro scrocco-mandata per serratura autobloccante per PVC	235	24	8	20		<b>226489</b>
		Scontro scrocco-mandata cava ferramenta contrapposta	235	24	8	20		<b>215197</b>
		Scontro scrocco-mandata AE per apriporta elettrico per PVC	250	32	8	20		<b>209104</b>
	sinistro	Scontro scrocco-mandata per serratura autobloccante per PVC	250	32	8	20		<b>219258</b>
		Scontro scrocco-mandata cava ferramenta contrapposta	175	18	9	50		<b>58675</b>
		Scontro scrocco-mandata cava ferramenta contrapposta pressione - 1 mm	175	18	9	50		<b>58715</b>
		Scontro scrocco-mandata per serratura autobloccante per PVC	235	24	8	20	A	<b>226490</b>
		Scontro scrocco-mandata cava ferramenta contrapposta	235	24	8	20		<b>215201</b>
Scontro scrocco-mandata AE per apriporta elettrico per PVC	250	32	8	20		<b>209105</b>		
Scontro scrocco-mandata per serratura autobloccante per PVC	250	32	8	20	B	<b>219259</b>		

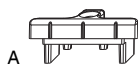

8.2.2 Scontri per nottolino			L	B	H		N <sup>o</sup>	
argento	Scontro nottolino cava ferramenta contrapposta pressione - 1 mm		48	19	8	200		<b>34606</b>
	Scontro nottolino cava ferramenta contrapposta		48	17	8	200	A	<b>34610</b>
	Scontro nottolino cava ferramenta contrapposta pressione -2 mm		48	19	8	200		<b>94463</b>

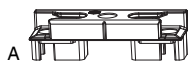

8.2.3 Scontri per fungo			L	B	H		N <sup>o</sup>	
argento	destro	Scontro per fungo per PVC	80	30	8	20		<b>354987</b>
	sinistro	Scontro per fungo per PVC	80	30	8	20		<b>355000</b>
	Scontro fungo cava ferramenta contrapposta pressione - 0,8 mm		68	20	9	100	A	<b>96558</b>



8.2.4 Scontri per gancio-punzone			L	B	H		N <sup>o</sup>	
argento	Scontro gancio-punzone per PVC		160	29,5	8	20		<b>211544</b>
	Scontro gancio-punzone per cava ferramenta		180	18	8	20	A	<b>217676</b>
	Scontro scrocco-gancio per cava ferramenta		180	32	6	20		<b>219260</b>



8.2.5 Scontri per scrocco			L	B	H		N <sup>o</sup>	
argento	Scontro scrocco con inserto cava ferramenta contrapposta		120	24		20	A	<b>215497</b>
	Scontro scrocco per cava ferramenta		150	32	7	20		<b>209979</b>

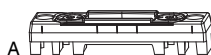

8.2.6 Scontri per scrocco portafinestra			L	B	H		N <sup>o</sup>	
argento	Scontro scrocco cremonese portafinestra per cava ferramenta		80	17	6,5	50	A	<b>35250</b>

### 8.3 Asta scontri legno



8.3.1 Asta Scontri legno U-6x24x6 scostamento 13mm						L		N°	
argento	dx	2 scrocchi-ganci per Legno 12 A 13 Scost.	24	6	24	6	2.200	5	<b>218784<sup>1</sup></b>
		2 scrocchi-ganci K+ 605 per Legno 12 A 13 Scost.	24	6	24	6	2.035	5	<b>224649<sup>1</sup></b>
		2 scrocchi-ganci K+ 980 per Legno 12 A 13 Scost.	24	6	24	6	2.200	5	<b>224651<sup>1</sup></b>
	4 ganci-punzoni per Legno 12 A 13 Scost.	24	6	24	6	2.200	5	<b>226733<sup>1,2</sup></b>	
sx		2 scrocchi-ganci per Legno 12 A 13 Scost.	24	6	24	6	2.200	5	<b>218785<sup>1</sup></b>
		2 scrocchi-ganci K+ 605 per Legno 12 A 13 Scost.	24	6	24	6	2.035	5	<b>224650<sup>1</sup></b>
		2 scrocchi-ganci K+ 980 per Legno 12 A 13 Scost.	24	6	24	6	2.200	5	<b>224652<sup>1</sup></b>
		4 ganci-punzoni per Legno 12 A 13 Scost.	24	6	24	6	2.200	5	<b>226734<sup>1,2</sup></b>

<sup>1</sup> Utilizzabile con copri vite 362704

<sup>2</sup> Viene utilizzato con serratura comando cilindro modulare Z-TS

## 8.4 Scontri e asta scontri PVC

### 8.4.1 Scontri e aste scontri per serratura autobloccante

Profili	Scontro scrocco-mandata per serratura autobloccante e destro	Scontro scrocco-mandata per serratura autobloccante e sinistro	Scontro scrocco-gancio	Asta scontri 2 scrocco-ganci destra	Asta scontri 2 scrocco-ganci sinistra	Asta scontri 2 scrocco-ganci + delimitatore d'apertura destra	Asta scontri 2 scrocco-ganci + delimitatore d'apertura sinistra	Asta scontri 2 scrocco-ganci K+605 destra	Asta scontri 2 scrocco-ganci K+605 sinistra	Asta scontri 2 scrocco-ganci K+980 destra	Asta scontri 2 scrocco-ganci K+980 sinistra
In Alpha 70 Prestigio	225715	225716	225717	-	-	-	-	-	-	-	-
Aluplast 2000	219431	219432	219433	219429	219430	225051	225052	219436	219437	219434	219435
Aluplast 4000/5000/6000	217924	217925	217930	217920	217921	225047	225048	217922	217923	217926	217927
Cava ferramenta contrapposta	219258	219259	219260	219225	219226	-	-	219227	219228	219229	219230
Brüggmann AD	217936	217937	217941	217932	217933	225866	225867	217934	217935	217938	217939
Deceuninck Zendow/Elegant/Thermofibra	224053	224054	219322	219318	219319	-	-	219325	219326	219323	219324
Gealan S 3000/7000/8000/9000	217914	217915	217918	217910	217911	225055	225056	217912	217913	217916	217917
Inoutic AD/Prestige	219252	219253	219254	219210	219211	225882	225883	219212	219213	219214	219215
KBE System 70 AD	224097	224098	224064	226482	226483	-	-	226484	226485	226486	226487
Kömmerling Eurofutur/Eurodur	217947	217948	217951	217943	217944	224862	224863	217945	217946	217949	217950
Kömmerling Eurofutur 88+ MD	217947	217948	217951	217943	217944	224862	224863	217945	217946	217949	217950
Profine 76/88	224097	224098	224064	226482	226483	-	-	226484	226485	226486	226487
Rehau S 730	219249	219250	219251	219204	219205	225039	225040	219206	219207	219208	219209
Rehau Tritec/S706 New	224039	224040	224059	-	-	225043	225044	-	-	-	-
Rehau Geneo/Synego	217957	217958	217961	217953	217954	225043	225044	217891	217892	217903	217904
Salamander 2D/3D/Streamline 76	217924	217925	217930	217920	217921	225047	225048	217922	217923	217926	217927
Salamander bluEvolution	217957	217958	217961	217953	217954	225043	225044	217891	217892	217903	217904
Salamander bluEvolution 82	217936	217937	217941	217932	217933	-	-	217934	217935	217938	217939
Salamander Streamline	217924	217925	217930	217920	217921	225047	225048	217922	217923	217926	217927
Schüco CT 70 - AS	219431	219432	219433	219429	219430	225051	225052	219436	219437	219434	219435
Schüco Si 82	219431	219432	219433	219429	219430	225051	225052	219436	219437	219434	219435
Veka Softline/Topline con cava ferramenta	217936	217937	217941	217932	217933	-	-	217934	217935	217938	217939
Veka Softline/Topline senza cava ferramenta	219499	219500	219501	224083	224084	227795	227796	224085	224086	224087	224088
Veka Softline/Topline senza cava ferramenta larghezza 44mm pressione - 1 mm	226094	226095	226096	226080	226081	-	-	226082	226083	226084	226085
Veka cava ferramenta contrapposta scost. 15 mm	227386	227387	224923	-	-	-	-	-	-	-	-
Wymar Profex 3000	219361	219362	219363	219359	219360	-	-	219366	219367	219364	219365

#### 8.4.2 Scontri e aste scontri per serratura comando cilindro modulare/automatica

Profili	Scontro scrocco-man-data per apripor-ta elett-rico destra	Scontro scrocco-man-data per apripor-ta elett-rico sinistra	Scontro gancio-punzione	Scontro per deli-mitatore d'apertu-ra destro	Scontro per deli-mitatore d'apertu-ra sinistro	Asta scontri 2 scroc-chi-gan-ci destra	Asta scontri 2 scroc-chi-gan-ci sinistra	Asta scontri 2 scroc-chi-gan-ci K+605 destra	Asta scontri 2 scroc-chi-gan-ci K+605 sinistra	Asta scontri 2 scroc-chi-gan-ci K+980 destra	Asta scontri 2 scroc-chi-gan-ci K+980 sinistra
Aluplast 2000	209094	209095	211557	-	-	219429	219430	219436	219437	219434	219435
Aluplast 4000/5000/6000	209099	209100	211543	212934*	212935*	217920	217921	217922	217923	217926	217927
Cava ferramenta contrapposta	209104	209105	211544	-	-	219225	219226	219227	219228	219229	219230
Brüggmann AD	209109	209110	211545	214367*	214368*	217932	217933	217934	217935	217938	217939
Deceuninck Zendow/Elegant/Thermofibra	209124	209125	211549	-	-	219318	219319	219325	219326	219323	219324
Dimex Komfort	209099	209100	211543	-	-	-	-	-	-	-	-
Gealan S 3000/7000/8000/9000	209134	209135	211550	214369*	214370*	217910	217911	217912	217913	217916	217917
Inoutic AD/Prestige	209179	209180	211555	-	-	219210	219211	219212	219213	219214	219215
KBE System 70 AD	209139	209140	211551	215432*	215433*	226482	226483	226484	226485	226486	226487
Kömmerling Eurofutur/Eurodur	215199	215204	211552	-	-	217943	217944	217945	217946	217949	217950
Kömmerling Eurofutur 88+ MD	215199	215204	211552	-	-	217943	217944	217945	217946	217949	217950
Kömmerling Gold 70	209139	209140	211551	215432*	215433*	226482	226483	226484	226485	226486	226487
Profine 76/88	209139	209140	211551	215432	215433	226482	226483	226484	226485	226486	226487
Rehau S 730	209159	209160	211553	-	-	219204	219205	219206	219207	219208	219209
Rehau Geneo/Tritec/S706 New/Synego	209164	209165	-	-	-	-	-	-	-	-	-
Salamander Streamline 76/2D/3D	209169	209170	211554	-	-	217920	217921	217922	217923	217926	217927
Salamander bluEvolution	213592	213593	213595	-	-	217953	217954	217891	217892	217903	217904
Salamander bluEvolution 82	209109	209110	211145	214367	214368	217932	217933	217934	217935	217938	217939
Schüco CT 70 - AS	209094	209095	211557	-	-	219429	219430	219436	219437	219434	219435
Schüco Si 82	209094	209095	211557	-	-	219429	219430	219436	219437	219434	219435
Veka Softline/Topline con cava ferramenta	209109	209110	211545	214367*	214368*	217932	217933	217934	217935	217938	217939
Veka Softline/Topline senza cava ferramenta	219502	219503	219501	216488	216489	224083	224084	224085	224086	224087	224088
Veka Softline/Topline senza cava ferramenta larghezza 44mm pressione -1 mm	226097	226098	226096	-	-	226080	226081	226082	226083	226084	226085
Veka cava ferramenta contrapposta scost. 15 mm	224921	224922	224923	-	-	-	-	-	-	-	-

## 8.5 Scontri Alu

### 8.5.1 Scontri Alu 3 mm battuta liscia scost. 13

#### 8.5.1.1 Scontri



##### 8.5.1.1.1 Scontri per scrocco-mandata

			L	B	H		Nº
argento	destro	Scontro scrocco-mandata per alluminio	250	24	3	20	<b>212282<sup>1</sup></b>
		Scontro scrocco-mandata per serratura autobloccante per alluminio	250	24	3	20	<b>219183<sup>1</sup></b>
	sinistro	Scontro scrocco-mandata per alluminio	250	24	3	20	A <b>212283<sup>1</sup></b>
		Scontro scrocco-mandata per serratura autobloccante per alluminio	250	24	3	20	B <b>219184<sup>1</sup></b>

<sup>1</sup> Utilizzabile con apriporta elettrico 478680 + 477536.

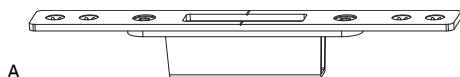



##### 8.5.1.1.2 Scontri gancio-punzone

			L	B	H		Nº
argento	Scontro gancio-punzone per alluminio		190	24	3	20	A <b>216981</b>

#### 8.5.1.2 Asta scontri



##### 8.5.1.2.1 Asta scontri scrocco-gancio

				L		Nº
argento	dx	2 scrocchi-ganci per Alu	24	1.680	5	A <b>219038<sup>1</sup></b>
		2 scrocchi-ganci K+ 605 per Alu	24	1.555	5	B <b>219040<sup>1</sup></b>
		2 scrocchi-ganci K+ 980 per Alu	24	1.930	5	C <b>219042<sup>1</sup></b>
	sx	2 scrocchi-ganci per Alu	24	1.680	5	<b>219039<sup>1</sup></b>
		2 scrocchi-ganci K+ 605 per Alu	24	1.555	5	<b>219041<sup>1</sup></b>
		2 scrocchi-ganci K+ 980 per Alu	24	1.930	5	<b>219043<sup>1</sup></b>

<sup>1</sup> Utilizzabile con apriporta elettrico 478680 + 477536.

## 8.5.2 Scontri Alu 3 mm scost.10 canalino 14mm

### 8.5.2.1 Scontri

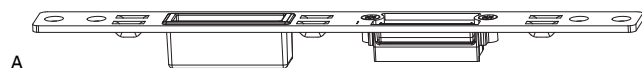

A

#### 8.5.2.1.1 Scontri per scrocco-mandata

			L	B	H			Nº
argento	destro	Scontro scrocco-mandata per ALU canalino telaio 14mm	270	24	3	20	A	214407 <sup>1</sup>
		Scontro scrocco-mandata per serratura autobloccante per ALU canalino telaio 14mm	270	24	3	20		219036 <sup>1</sup>
	sinistro	Scontro scrocco-mandata per ALU canalino telaio 14mm	270	24	3	20		214408 <sup>1</sup>
		Scontro scrocco-mandata per serratura autobloccante per ALU canalino telaio 14mm	270	24	3	20		219037 <sup>1</sup>

<sup>1</sup> Utilizzabile con apriporta elettrico 478681.

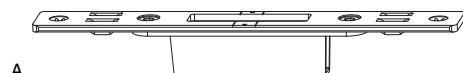

A



#### 8.5.2.1.2 Scontri gancio-punzone

			L	B	H			Nº
argento		Scontro gancio-punzone per ALU canalino telaio 14mm	190	25	3	20	A	214409

### 8.5.3 Scontri Alu U-6/24/6 scost. 13

#### 8.5.3.1 Scontri





8.5.3.1.1 Scontri per scrocco-mandata					<b>L</b>		<b>Nº</b>
argento	dx	Scontro scrocco-mandata per Alu	6	6	235	20	<b>214693</b>
		Scontro scrocco-mandata A-TS per Alu	6	6	240	20	<b>251674</b>
	sx	Scontro scrocco-mandata per Alu	6	6	235	20	<b>214694</b>
		Scontro scrocco-mandata A-TS per Alu	6	6	240	20	<b>251675</b>



8.5.3.1.2 Scontri gancio-punzone		<b>L</b>	<b>B</b>	<b>H</b>		<b>Nº</b>
argento	Scontro gancio-punzone per alluminio	160	24	6	20	<b>213180<sup>1</sup></b>



<sup>1</sup> Utilizzabile con coprifresata 358027



8.5.3.1.3 Scontri per delimitatore d'apertura				<b>B</b>		<b>L</b>		<b>Nº</b>
argento	dx	Scontro per delimitatore d'apertura	6	24	6	220	20	<b>216754</b>
	sx	Scontro per delimitatore d'apertura	6	24	6	220	20	<b>216755</b>



#### 8.5.3.2 Asta scontri



8.5.3.2.1 Asta scontri gancio-punzone					<b>L</b>		<b>Nº</b>
argento	dx	4 ganci-punzoni	6	6	1.850	5	<b>208470<sup>1</sup></b>
	sx	4 ganci-punzoni	6	6	1.850	5	<b>208471<sup>1</sup></b>

<sup>1</sup> Utilizzabile con apriporta elettrico 478682 + 477428.





8.5.3.2.2 Asta scontri scrocco-gancio				<b>B</b>		<b>L</b>		<b>Nº</b>
argento	dx	2 scrocchi-ganci	6	24	6	1.620	5	<b>251680</b>
						1.745	5	<b>251635</b>
						1.995	5	<b>251682</b>
	sx	2 scrocchi-ganci	6	24	6	1.620	5	<b>251681</b>
						1.745	5	<b>251636</b>
						1.995	5	<b>251683</b>

### 8.5.4 Scontri Alu scost.9 canalino 14 mm

#### 8.5.4.1 Scontri per porte ad 1 anta



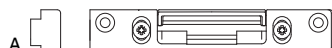

##### 8.5.4.1.1 Scontri per scrocco-mandata

				<b>B</b>		<b>H</b>	<b>L</b>		<b>Nº</b>
argento	dx	Scontro scrocco-mandata -2	6	24	6		235	20	A <b>250508</b>
	dx/sx	Scontro scrocco-mandata -0,5		18		6	208	50	<b>212820</b>
	sx	Scontro scrocco-mandata -2	6	24	6	6	235	20	<b>250509</b>



##### 8.5.4.1.2 Scontri per scrocco

			<b>B</b>	<b>L</b>			<b>Nº</b>
argento	Scontro scrocco per alluminio		18	107,2	18	50	A <b>212371</b>



##### 8.5.4.1.3 Scontri gancio-punzone

			<b>L</b>	<b>B</b>	<b>H</b>		<b>Nº</b>	
argento	dx / sx	Scontro gancio-punzone per alluminio	180	18	6	20	A <b>250510</b>	
							20	<b>215785<sup>1</sup></b>

<sup>1</sup> Utilizzabile con coprifresata 358024



##### 8.5.4.1.4 Scontri catenaccio

			<b>L</b>	<b>B</b>	<b>H</b>		<b>Nº</b>
argento	Scontro catenaccio 2 fori per canalino euro 7/8x4		120	18	8	20	A <b>50579</b>



##### 8.5.4.1.5 Scontri fungo

			<b>L</b>	<b>B</b>	<b>H</b>		<b>Nº</b>
argento	Scontro fungo per alluminio scost.9		68	19	9	100	A <b>356361</b>

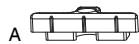

##### 8.5.4.1.6 Scontri



			<b>L</b>	<b>B</b>	<b>H</b>		<b>Nº</b>
argento	Scontro nottolino per alluminio		48	19	8	200	A <b>356362</b>
	Scontro nottolino per alluminio pressione - 1 mm		48	19,5		100	<b>361453</b>

## 8.5.5 Scontri Alu scost.13 canalino 14 mm

### 8.5.5.1 Scontri per porte ad 1 anta





#### 8.5.5.1.1 Scontri per scrocco-mandata

				<b>B</b>		<b>L</b>			<b>N<sup>o</sup></b>
argento	dx	Scontro scrocco-mandata -2	6	24	6	235	20	A	<b>228443<sup>1</sup></b>
		Scontro scrocco-mandata	6	24	6	235	20		<b>224409<sup>1</sup></b>
	sx	Scontro scrocco-mandata -2	6	24	6	235	20		<b>228444<sup>1</sup></b>
		Scontro scrocco-mandata	6	24	6	235	20		<b>224410<sup>1</sup></b>

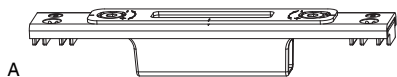
<sup>1</sup> Utilizzabile con apriporta elettrico 478682 + 477428.





#### 8.5.5.1.2 Scontri scrocco-gancio

				<b>B</b>				<b>N<sup>o</sup></b>
argento		Scontro scrocco-gancio -2	6	24	6	20	A	<b>228445</b>



#### 8.5.5.1.3 Scontri per scrocco

				<b>B</b>				<b>N<sup>o</sup></b>
argento		Scontro scrocco -1	6	24	6	20	A	<b>219269<sup>1</sup></b>

<sup>1</sup> Utilizzabile con apriporta elettrico 478682 + 477428.



#### 8.5.5.1.4 Scontri catenaccio

			<b>L</b>	<b>B</b>	<b>H</b>			<b>N<sup>o</sup></b>
argento		Scontro catenaccio 2 fori per alluminio	133	24	8	20	A	<b>228850</b>



#### 8.5.5.1.5 Scontri fungo

			<b>L</b>	<b>B</b>	<b>H</b>			<b>N<sup>o</sup></b>
argento		Scontro fungo per alluminio	68	22	9	100	A	<b>360694</b>

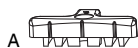

#### 8.5.5.1.6 Scontri

			<b>L</b>	<b>B</b>	<b>H</b>			<b>N<sup>o</sup></b>
argento		Scontro nottolino per alluminio	48	22,5	8	200	A	<b>360693</b>

## 9 Asta a leva

---

<b>9.1</b>	<b>Composizione asta a leva</b>	<b>86</b>
<b>9.2</b>	<b>Aste a leva modulare</b>	<b>87</b>
9.2.1	Asta a leva modulare per legno/Alu scost.13 mm PB24 U-6x24x6	87
9.2.2	Asta a leva modulare per PVC scost.13 mm U-6x28x6	87
9.2.3	Asta a leva modulare per PVC scost.15 mm U-6x28x6	87
<b>9.3</b>	<b>Asta a leva</b>	<b>88</b>
9.3.1	Aste a leva 4 funghi HM1050 F16	88
9.3.2	Terminale per asta a leva F16 senza scontro integrato	88
9.3.3	Chiusura angolare	88
9.3.4	Movimento angolare con 1 fungo	88
9.3.5	Giunzione accorciamento per serratura	88
<b>9.4</b>	<b>Terminali per asta a leva modulare</b>	<b>89</b>
9.4.1	Terminale per legno/Alu A12 scost.13 mm PB24 U-6x24x6	89
9.4.2	Terminale per PVC scost.13 mm U-6x28x6	89
9.4.3	Terminale per PVC scost.15 mm U-6x28x6	89
<b>9.5</b>	<b>Componenti modulari per asta a leva modulare</b>	<b>91</b>
9.5.1	Componenti modulari per legno/Alu A12 scost.13 mm PB24 U-6x24x6	91
9.5.2	Componenti modulari per PVC scost.13 mm U-6x28x6	91
9.5.3	Componenti modulari per PVC scost.15 mm U-6x28x6	91

## 9 Asta a leva

### 9.1 Composizione asta a leva

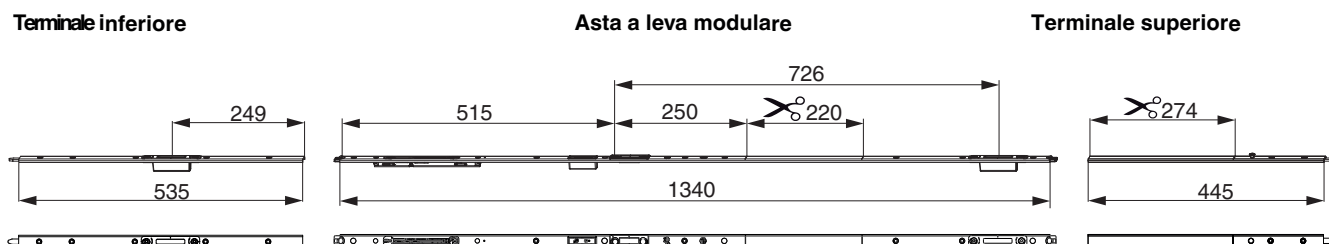

#### Giunzione accorciamento



#### Giunzione prolunga

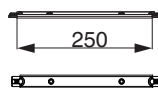

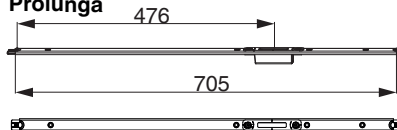

#### Prolunga







## 9.2 Aste a leva modulare







9.2.1 Asta a leva modulare per legno/Alu scost.13 mm PB24 U-6x24x6					L		No		
argento	dx/sx	1 scrocco-gancio	6	24	6	1.340	5	A	251406
		1 scrocco-gancio K+ 605	6	24	6	1.215	5		251405
		1 scrocco-gancio K+ 980	6	24	6	1.590	5		251407
dx		1 scrocco-gancio per apriporta elettrico	6	24	6	1.340	5		251395
		1 scrocco-gancio K+ 605 per apriporta elettrico	6	24	6	1.215	5		251393
		1 scrocco-gancio K+ 980 per apriporta elettrico	6	24	6	1.590	5		251397
sx		1 scrocco-gancio per apriporta elettrico	6	24	6	1.340	5		251396
		1 scrocco-gancio K+ 605 per apriporta elettrico	6	24	6	1.215	5		251394
		1 scrocco-gancio K+ 980 per apriporta elettrico	6	24	6	1.590	5		251398



9.2.2 Asta a leva modulare per PVC scost.13 mm U-6x28x6					L		No		
argento	dx	1 scrocco-gancio	6	28	6	1.340	5	A	251418
		1 scrocco-gancio K+ 605	6	28	6	1.215	5		251416
		1 scrocco-gancio K+ 980	6	28	6	1.590	5		251420
sx		3 scrocchi-ganci	6	28	6	1.340	5		251446
		1 scrocco-gancio	6	28	6	1.340	5		251419
		1 scrocco-gancio K+ 605	6	28	6	1.215	5		251417
		1 scrocco-gancio K+ 980	6	28	6	1.590	5		251421
		3 scrocchi-ganci	6	28	6	1.340	5		251447



9.2.3 Asta a leva modulare per PVC scost.15 mm U-6x28x6					L		No		
argento	dx	1 scrocco-gancio	6	28	6	1.340	5	A	251429
		1 scrocco-gancio K+ 605	6	28	6	1.215	5		251427
		1 scrocco-gancio K+ 980	6	28	6	1.590	5		251431
sx		1 scrocco-gancio	6	28	6	1.340	5		251430
		1 scrocco-gancio K+ 605	6	28	6	1.215	5		251428
		1 scrocco-gancio K+ 980	6	28	6	1.590	5		251432

### 9.3 Asta a leva



#### 9.3.1 Aste a leva 4 funghi HM1050 F16



**Nº**

argento	dx	4 funghi	1.050	16	2.150	5	A	<b>250970</b>
	sx	4 funghi	1.050	16	2.150	5		<b>250971</b>



#### 9.3.2 Terminale per asta a leva F16 senza scontro integrato



**Nº**

argento					113,5	20	A	<b>208432</b>
---------	--	--	--	--	-------	----	---	---------------



#### 9.3.3 Chiusura angolare



**Nº**

argento					113,5	50	A	<b>209881</b>
						50		<b>222208</b>



#### 9.3.4 Movimento angolare con 1 fungo



**Nº**

argento					113,5	50	A	<b>222201</b>
---------	--	--	--	--	-------	----	---	---------------

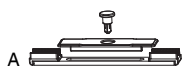

#### 9.3.5 Giunzione accorciamento per serratura



**Nº**



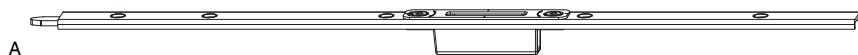

argento			16	50	10		A	<b>104790</b>
---------	--	--	----	----	----	--	---	---------------

## 9.4 Terminali per asta a leva modulare

### 9.4.1 Terminale per legno/Alu A12 scost.13 mm PB24 U-6x24x6







#### 9.4.1.1 Terminale inferiore HM 1050

								<b>L</b>			<b>No</b>
argento	per legno/alu	12 A	scost. 13 mm dx/sx	6	24	6	10	535	5	A	<b>251454</b>





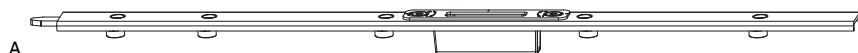

#### 9.4.1.2 Terminale superiore rasabile

								<b>L</b>			<b>No</b>
argento	per legno/alu	12 A	scost. 13 mm dx/sx	6	24	6	10	445	10	A	<b>251448</b>

### 9.4.2 Terminale per PVC scost.13 mm U-6x28x6





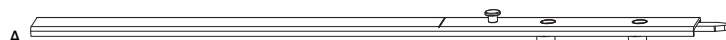

#### 9.4.2.1 Terminale inferiore HM 1050

								<b>L</b>			<b>No</b>
argento	per PVC	scost. 13 mm	dx	6	28	6	10	535	10	A	<b>251471</b>
			sx	6	28	6	10	535	10		<b>251472</b>







#### 9.4.2.2 Terminale superiore rasabile

								<b>L</b>			<b>No</b>
argento	per PVC	scost. 13 mm	dx	6	28	6	10	445	10	A	<b>251647</b>
			sx	6	28	6	10	445	5		<b>251648</b>

### 9.4.3 Terminale per PVC scost.15 mm U-6x28x6





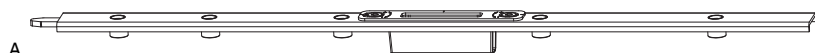

#### 9.4.3.1 Terminale inferiore HM 1050





								<b>L</b>			<b>No</b>
argento	per PVC	scost. 15 mm	dx	6	28	6	10	535	10	A	<b>251465</b>
			sx	6	28	6	10	535	5		<b>251466</b>

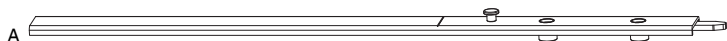

#### 9.4.3.2 Terminale inferiore HM 1020





								<b>L</b>			<b>No</b>
argento	per PVC	scost. 15 mm	dx	6	28	6	10	505	10	A	<b>251463</b>
			sx	6	28	6	10	505	10		<b>251464</b>







9.4.3.3 Terminale superiore rasabile								L			N <sup>o</sup>
argento	per PVC	scost. 15 mm	dx	6	28	6	10	445	10	A	251461
			sx	6	28	6	10	445	10		251462

## 9.5 Componenti modulari per asta a leva modulare





A 

9.5.1 Componenti modulari per legno/Alu A12 scost.13 mm PB24 U-6x24x6						L			N <sup>o</sup>
argento	Giunzione accorciamento serratura	scost. 13 mm dx/sx	6	24	6	50	10	A	251473
	Prolunga per serratura	scost. 13 mm dx/sx	6	24	6	250	5		251474
	Prolunga	scost. 13 mm dx/sx	6	24	6	705	5		251477

A 

9.5.2 Componenti modulari per PVC scost.13 mm U-6x28x6						L			N <sup>o</sup>
argento	Giunzione accorciamento serratura	scost. 13 mm dx	6	28	6	50	10	A	251484
		scost. 13 mm sx	6	28	6	50	10		251485
	Prolunga per serratura	scost. 13 mm dx/sx	6	28	6	250	5		251486
	Prolunga	scost. 13 mm dx	6	28	6	705	5		251488
		scost. 13 mm sx	6	28	6	705	5		251489

A 

9.5.3 Componenti modulari per PVC scost.15 mm U-6x28x6						L			N <sup>o</sup>
argento	Giunzione accorciamento serratura	scost. 15 mm dx	6	28	6	50	10	A	251490
		scost. 15 mm sx	6	28	6	50	10		251491
	Prolunga per serratura	scost. 15 mm dx/sx	6	28	6	250	5		251492
	Prolunga	scost. 15 mm dx	6	28	6	705	5		251494
		scost. 15 mm sx	6	28	6	705	5		251495



Asta a leva

## 10 Catenacci

---





<b>10.1 Catenaccio per portoncino</b>	<b>94</b>
10.1.1 Catenaccio per portoncino A4	94
10.1.2 Catenaccio per portoncino A12	95
10.1.3 Catenaccio per portoncino per cava ferramenta	96
10.1.4 Catenaccio per portoncino larghezza 18 mm	96
<b>10.2 Catenaccio porta interna</b>	<b>96</b>
10.2.1 Catenaccio porta interna A4	96

## 10 Catenacci

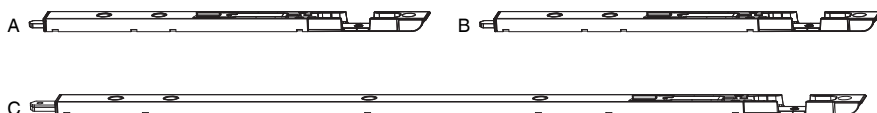
### 10.1 Catenaccio per portoncino



#### 10.1.1 Catenaccio per portoncino A4



10.1.1.1 Catenaccio per portoncino A4 scost. 9 mm					L		No	
argento	Aria 4	R8	11	8	255	20	A	<b>58464</b>
					540	20		<b>58468</b>
			18	8	255	20	B	<b>208998</b>
		540			20		<b>208999</b>	
		10	8	540	20	C	<b>55985</b>	
				255	20		<b>55989</b>	
		inferiore sinistro	R8	18	7	255	20	
inferiore destro	R8	18	7	255	20		<b>59425</b>	
		R8	18	10	185	20		<b>457573<sup>1</sup></b>





<sup>1</sup> Prodotto commercializzato da MACO. Il produttore di questo articolo® è elencato alla voce "Prodotti commercializzati" nelle "Norme sulla responsabilità del produttore". Per questo prodotto valgono tutte le specifiche tecniche, le note, le istruzioni e le linee guida del produttore, nonché esclusivamente le sue garanzie.



10.1.1.2 Catenaccio per portoncino A4 scost. 13 mm U-6x24x6					L		No	
argento	A4 sc.13	sinistro	20	10	120	20		<b>213834</b>
		destro	20	10	120	20	A	<b>213833</b>
		superiore destro	20	10	560	20	B	<b>219513</b>
		superiore sinistro	20	10	560	20		<b>219514</b>
		inferiore destro	20	10	275	20		<b>219515</b>
		inferiore sinistro	20	10	275	20		<b>219516</b>
		superiore destro	20	10	275	20		<b>219517</b>
		superiore sinistro	20	10	275	20		<b>219518</b>



### 10.1.2 Catenaccio per portoncino A12



10.1.2.1 Catenaccio per portoncino A12 scost. 9 mm						L		No
argento	Aria 4	R8	11	8	255	20		<b>58464<sup>1</sup></b>
					540	20		<b>58468<sup>1</sup></b>
		18	8	255	20		<b>208998<sup>1</sup></b>	
				540	20		<b>208999<sup>1</sup></b>	
	battuta liscia	18	10	200	20		A	<b>210876</b>
						255	20	B

<sup>1</sup> Deve essere utilizzato con terminale 43718!





10.1.2.2 Catenaccio per portoncino A12 canalino euro 6/8/4					L		No
argento	canalino Euro 6/8/4	sinistro	11	8	255	20	<b>58609</b>
		destro	11	8	255	20	A <b>58608</b>





10.1.2.3 Catenaccio per portoncino A12 canalino euro 7/8/4					L		No	
argento	canalino Euro 7/8/4	sinistro	11	8	255	20	<b>59428</b>	
					540	20	<b>59430</b>	
		destro	11	8	255	20	A <b>59429</b>	
					540	20	<b>59431</b>	
		sinistro	18	10	255	20		<b>58575</b>
							destro	18





10.1.2.4 Catenaccio per portoncino A12 scost. 13 mm U-6x24x6					L		No
argento	per A12 scostamento 13	destro	20	10	120	20	A <b>213831</b>
		sinistro	20	10	120	20	<b>213832</b>
		superiore destro	20	10	560	20	<b>219519</b>
		superiore sinistro	20	10	560	20	<b>219520</b>
		inferiore destro	20	10	275	20	<b>219521</b>
		inferiore sinistro	20	10	275	20	<b>219522</b>
		superiore destro	20	10	275	20	<b>219523</b>
		superiore sinistro	20	10	275	20	<b>219524</b>

### 10.1.3 Catenaccio per portoncino per cava ferramenta







10.1.3.1 Catenaccio per portoncino U-6x24x6				L		No	
argento	per cava ferramenta	sinistro	20	10	120	20	<b>213830</b>
	guarnizione centrale MD	destro	20	10	120	20	A <b>213829</b>



10.1.3.2 Catenaccio per portoncino U-6x32x6				L		No	
argento	per cava ferramenta	destro	20	10	130	20	A <b>213825</b>
		sinistro	20	10	130	20	<b>213826</b>





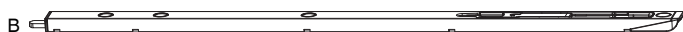
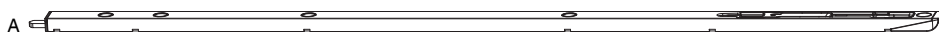

10.1.4 Catenaccio per portoncino larghezza 18 mm					L		No
argento	Aria 4	R8	11	8	255	20	<b>58464<sup>1</sup></b>
					540	20	<b>58468<sup>1</sup></b>
			18	8	255	20	A <b>208998<sup>1</sup></b>
					540	20	<b>208999<sup>1</sup></b>
			10	8	540	20	<b>55985<sup>1</sup></b>
					255	20	<b>55989<sup>1</sup></b>

<sup>1</sup> Deve essere utilizzato con spessore per cava ferramenta!

### 10.2 Catenaccio porta interna



10.2.1 Catenaccio porta interna A4					L		No	
argento	Aria 4	R8	12	8	600	20	A <b>58465</b>	
					540	20	<b>209000</b>	
					255	20	<b>57915</b>	
			R90	12	8	425	20	B <b>57916</b>
						255	20	<b>58029</b>
						425	20	<b>58030</b>
			600	20	<b>58469</b>			

## 11 Accessori

---

11.1	Accessori per alluminio	98
11.2	Sorveglianza della chiusura	98
11.3	Scrocco a rullo per serrature comando cilindro	98
11.4	Scrocco smussato per serrature comando cilindro	98
11.5	Spessori catenaccio	99
11.6	Terminali	99
11.7	Coprifresate	99
11.8	Coperture	99
11.9	Frontali di copertura	99
11.10	Boccola a pavimento	100
11.11	Chiave per prova serratura	100
11.12	Antistrappo	100
11.13	Clip per scrocco per apriporta elettrico	100
11.14	Apriporta elettrico MACO	101
11.15	Scrocco MACO per apertura giorno	101
11.16	Dime	102

## 11 Accessori



A

### 11.1 Accessori per alluminio



**Nº**

Coprifresata serratura per scontro scrocco-mandata nero

50

A

**360397**

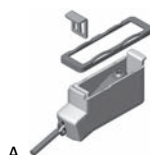

A

### 11.2 Sorveglianza della chiusura



**Nº**

Contatto mandata per scontro scrocco-mandata lunghezza cavo 6m VdS C

1

A

**478679**

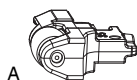

A

### 11.3 Scrocco a rullo per serrature comando cilindro



**Nº**

Scrocco a rullo

serratura comando cilindro Protect

E 35

10

A

**203784**

E 40

10

**203785**

E 45

10

**203786**

E 50

10

**203787**

E 55

10

**203788**

E 65

10

**203790**

E 70

10

**203791**

E 80

10

**203792**



A

### 11.4 Scrocco smussato per serrature comando cilindro



**Nº**

Scrocco ridotto Protect serratura comando cilindro E 35

10

A

**101555**

Scrocco ridotto Protect serratura comando cilindro E 40

10

**101556**

Scrocco ridotto Protect serratura comando cilindro E 45

10

**101553**

Scrocco ridotto Protect serratura comando cilindro E 50

10

**101557**

Scrocco ridotto Protect serratura comando cilindro E 55

10

**101477**

Scrocco ridotto Protect serratura comando cilindro E 65

10

**101558**

Scrocco ridotto Protect serratura comando cilindro E 70

10

**101559**

Scrocco ridotto Protect serratura comando cilindro E 80

10

**101560**

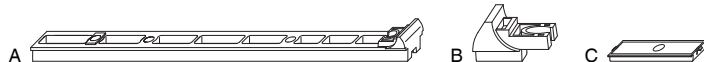

11.5 Spessori catenaccio		N <sup>o</sup>
Spessore catenaccio portoncino L=200 per serratura automatica	20	360159
Spessore per catenaccio per cava ferramenta xmm S=mm argento	50	A 44253
Inserto per catenaccio portafinestra A12 canalino Euro	100	B 44268
Spessore catenaccio A12 canalino Euro	100	C 44316
Spessore catenaccio portoncino dx cava ferramenta pressione -1mm	50	44372
Spessore catenaccio portoncino sx cava ferramenta pressione -1mm	50	44373
Spessore per catenaccio portoncino L=255 A4 scostamento 13 grigio	100	460342



11.6 Terminali		N <sup>o</sup>
Terminale in plastica per scontro ad angolo 30x8 legno PB 30 mm scost. 13 mm 30x19mm S=mm nero	100	369691
Inserto per scontro e catenaccio A4 su A12 battuta liscia/18	100	A 43718
Terminale in plastica per scontro ad angolo 24x8 A12 battuta liscia/24 24xmm S=mm nero	100	B 362920
Terminale in plastica per scontro scrocco battuta liscia PB 18 sc.9 xmm S=mm	100	C 360074
Terminale in plastica per scontro battuta liscia PB 20 sc.9 S=0mm argento	100	D 354358
Terminale in plastica per scontro destro canalino Euro xmm S=mm argento	100	E 44205
Terminale in plastica per scontro sinistro canalino Euro xmm S=mm argento	100	F 44206



11.7 Coprifresate		N <sup>o</sup>
Coprifresata Scontro gancio-punzone legno lungo dx+sx nero	50	A 358024
Coprifresata serratura per scontro scrocco-mandata nero	50	B 360397
Coprifresata Scontro scrocco-punzone PVC scostamento 11 mm per profili in PVC nero	50	355399
Coprifresata Scontro gancio-punzone per profili in PVC	50	358027
Coprifresata serratura per scontro scrocco-mandata per profili in legno argento	50	C 43524



11.8 Coperture		N <sup>o</sup>
Copertura per avvvitamento inclinato nero grafite RAL 9011	100	A 362704



11.9 Frontali di copertura		N <sup>o</sup>
Frontale di copertura F-1.400x24 argento	20	372697
Prolunga per asta scontri U-6/24/6 argento	5	A 102852
Frontale di copertura F-1.400x20 argento	20	B 364770
Frontale di copertura F-1.400x24/16 argento	20	364771
Frontale di copertura U-1.000x24 argento	5	103001



A

11.10 Boccola a pavimento		Nº
Boccola ad incasso D=14 H=22 per puntale 8x4 argento	100	A 94219
Boccola a pavimento per catenaccio 10x5 zincata	1	453541 <sup>1</sup>

<sup>1</sup> Prodotto commercializzato da MACO. Il produttore di questo articolo® è elencato alla voce "Prodotti commercializzati" nelle "Norme sulla responsabilità del produttore". Per questo prodotto valgono tutte le specifiche tecniche, le note, le istruzioni e le linee guida del produttore, nonché esclusivamente le sue garanzie.

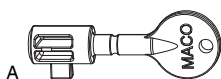

A

11.11 Chiave per prova serratura		Nº
Chiave per prova serratura	20	A 40720

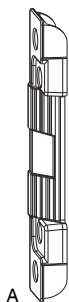

A

11.12 Antistrappo		Nº
Antistrappo parte telaio A4 scost. 13 mm argento	20	A 367738 <sup>1,2</sup>
Antistrappo parte telaio legno PB18/scost.9 e PB 22/scost.13 argento	20	367505
Antistrappo parte telaio canalino Euro argento	20	367722
Antistrappo parte anta argento	20	217584 <sup>3,4</sup>
Antistrappo parte telaio A4 scost. 9 mm argento	20	368014 <sup>2,5</sup>

<sup>1</sup> Profondità fresata 22 mm.

<sup>2</sup> Lunghezza fresata 120 mm.

<sup>3</sup> Per profili PVC e alu-legno consultare schede di profilo.

<sup>4</sup> L'anta deve essere dotata di cava ferramenta nel campo del pezzo anta.

<sup>5</sup> Profondità fresata 18 mm.



A

11.13 Clip per scrocco per apriporta elettrico		Nº
Clip per scrocco	50	A 43586
Clip per scrocco smussato	50	362906

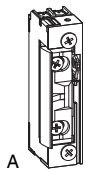

A

### 11.14 Apriporta elettrico MACO



**Nº**

Apriporta elettrico MACO stretto con scivolo per scrocco con sblocco meccanico con antiripetitore 10-24 V	100		<b>477428<sup>1</sup></b>
Apriporta elettrico MACO con sblocco meccanico con antiripetitore 10-24 V	1	A	<b>477536<sup>1</sup></b>
Apriporta elettrico MACO con sblocco meccanico e molla rinforzata 10-24 V	1		<b>478680<sup>1</sup></b>
Apriporta elettrico MACO stretto con scivolo per scrocco con sblocco meccanico e molla rinforzata 10-24 V	1		<b>478682<sup>1</sup></b>

<sup>1</sup> Ordinare anche il clip per scrocco

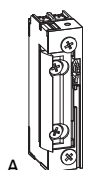

A

### 11.15 Scrocco MACO per apertura giorno



**Nº**

Scrocco per apertura giorno MACO con sblocco meccanico e molla rinforzata	1	A	<b>478684</b>
Scrocco per apertura giorno MACO stretto con scivolo per scrocco con sblocco meccanico e molla rinforzata	1		<b>478686</b>
Scrocco per apertura giorno MACO per scivolo scrocco con sblocco meccanico e molla rinforzata	1		<b>478687</b>

## 11.16 Dime

### 11.16.1 Dime per scontri

#### 11.16.1.1 Dime per scontri A4

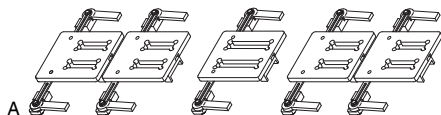

##### 11.16.1.1.1 Dime per 1 e 2 ante comando cilindro A4



**Nº**

Set dime per serratura comando cilindro e maniglia 4 funghi 1+2 ante per A4

1

A

**X928705**

#### 11.16.1.2 Dime pezzi sciolti

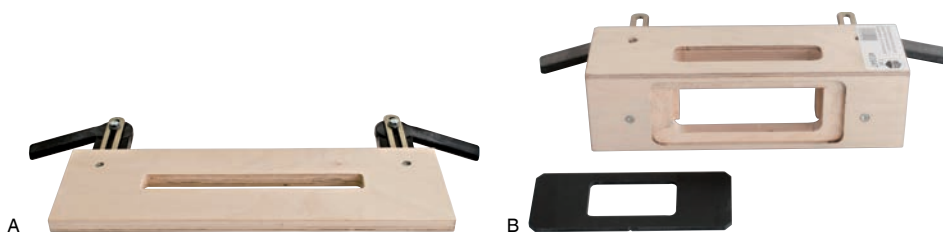

##### 11.16.1.2.1 Dime pezzi sciolti serratura A4



**Nº**

Dima per scontro scrocco-mandata A4 serratura autobloccante 220 x 8mm

1

A

**467734**

Dima per serratura comando maniglia e cilindro scontro scrocco mandata per aria 4 mm

1

A

**X801920**

Dima scontro punzone-gancio dx+sx per A4 fresatea L=180

1

A

**461742**

Dima per scontro scrocco ad angolo 8x24 dx+sx per A4 scostamento 13 L=24 argento

1

B

**463947**

Dima per scontro scrocco-mandata ad angolo 8x24 con inserto destro e sinistro per A4 scostamento 13 L=24 argento

1

A

**463945**

Dima per scontro gancio-punzone ad angolo 8x24 dx+sx per A4 scostamento 13 L=24 argento

1

A

**463946**

#### 11.16.1.3 Dime per scontri A12



##### 11.16.1.3.1 Dime per serratura comando cilindro A12 per scontri fungo L=48mm



**Nº**

Dima completa con guidascontro serratura comando cilindro a 4 funghi 1+2 ante per legno e PVC

1

A

**203797**

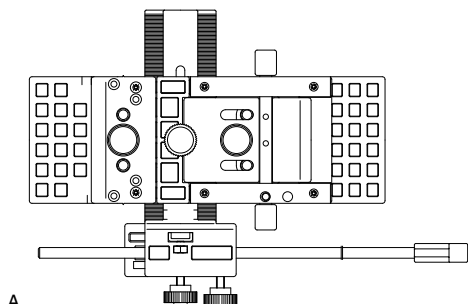

##### 11.16.1.4 Dima foro cilindro e maniglia



**Nº**

Dima forature per scatola serratura

1

A

**28603**

12 Indice articoli

<b>No</b>	<b>Gruppo</b>	 <b>€</b> (/00 = 100 pz.)	<b>Pagina</b>
<b>1</b>			
101477	IT-C-7-8	10	98
101488	IT-C-7-1	10	54
101490	IT-C-7-1	10	53
101553	IT-C-7-8	10	98
101555	IT-C-7-8	10	98
101556	IT-C-7-8	10	98
101557	IT-C-7-8	10	98
101558	IT-C-7-8	10	98
101559	IT-C-7-8	10	98
101560	IT-C-7-8	10	98
102852	IT-C-7-1	5	99
103001	IT-C-7-7	5	99
104130	IT-C-B-3	1	21
104785	IT-C-7-1	10	21,55
104786	IT-C-7-1	10	21,55
104787	IT-C-7-1	10	21,55
104788	IT-C-7-1	10	21,55
104789	IT-C-7-1	10	21,55
104790	IT-C-7-1	10	21,55,88
104791	IT-C-7-1	10	21,55
104792	IT-C-7-1	10	21,55
104793	IT-C-7-1	10	21,55
104794	IT-C-7-1	10	21,55
106054	IT-C-7-8	10	24
106144	IT-C-7-8	10	33
11243	IT-C-7-1	10	53
11244	IT-C-7-1	10	53
<b>2</b>			
200983	IT-C-7-1	10	54
200984	IT-C-7-1	10	54
200985	IT-C-7-1	10	54
200986	IT-C-7-1	10	54
200987	IT-C-7-1	10	54
203329	IT-A-1-9-4	100	75
203502	IT-C-7-2	20	66
203503	IT-C-7-2	20	66
203696	IT-C-5	5	63
203697	IT-C-7-1	10	64
203698	IT-C-7-1	10	64
203699	IT-C-7-1	10	64
203784	IT-C-7-8	10	98
203785	IT-C-7-8	10	98
203786	IT-C-7-8	10	98
203787	IT-C-7-8	10	98
203788	IT-C-7-8	10	98
203790	IT-C-7-8	10	98
203791	IT-C-7-8	10	98
203792	IT-C-7-8	10	98
203797	IT-S-1	1	102
203828	IT-C-5	5	63
203829	IT-C-5	5	63
203830	IT-C-5	5	63
203831	IT-C-5	5	63
203832	IT-C-5	5	63
203833	IT-C-5	5	63
207861	IT-C-7-3	20	68,73
207862	IT-C-7-3	20	67,72
208432	IT-A-7-2-3-4	20	64,88
208470	IT-C-7-4	5	82
208471	IT-C-7-4	5	82
208998	IT-C-7-5	20	94,95,96
208999	IT-C-7-5	20	94,95,96
209000	IT-T-1	20	96
209104	IT-C-7-2	20	76
209105	IT-C-7-2	20	76
209338	IT-A-1-9-4	100	70
209347	IT-C-7-3	50	75
209809	IT-C-7-2	50	74

<b>No</b>	<b>Gruppo</b>	 <b>€</b> (/00 = 100 pz.)	<b>Pagina</b>
209810	IT-C-7-2	50	74
209881	IT-A-6-1-9	50	88
209907	IT-C-7-2	50	69
209908	IT-C-7-2	50	69
209909	IT-C-7-3	20	69
209911	IT-C-7-3	20	70
209912	IT-C-7-3	20	70
209979	IT-C-7-3	20	76
210016	IT-C-7-2	20	74
210017	IT-C-7-2	20	74
210501	IT-C-7-3	20	67,72
210502	IT-C-7-3	20	68,73
210779	IT-C-7-3	20	74
210781	IT-C-7-3	20	75
210782	IT-C-7-3	20	75
210813	IT-C-7-2	20	71
210814	IT-C-7-2	20	71
210876	IT-C-7-5	20	95
211369	IT-A-1-9-4	100	75
211544	IT-C-7-3	20	76
211597	IT-C-7-3	20	70
211598	IT-C-7-3	20	75
212282	IT-C-7-2	20	80
212283	IT-C-7-2	20	80
212371	IT-C-7-3	50	83
212474	IT-A-1-9-4	100	75
212643	IT-C-7-1	5	55
212644	IT-C-7-1	5	56
212646	IT-C-7-1	5	55
212687	IT-A-6-2-9	20	64
212758	IT-C-7-1	5	55
212759	IT-C-7-1	5	56
212761	IT-C-7-1	5	55
212762	IT-C-7-1	5	55
212765	IT-C-7-1	5	55
212820	IT-C-7-2	50	83
212936	IT-C-7-3	20	67
212937	IT-C-7-3	20	67
212940	IT-C-7-3	20	72
212941	IT-C-7-3	20	72
213046	IT-C-7-1	5	56
213048	IT-C-7-1	5	56
213049	IT-C-7-1	5	56
213050	IT-C-7-1	5	56
213051	IT-C-7-1	5	56
213056	IT-C-7-1	5	56
213057	IT-C-7-1	5	56
213058	IT-C-7-1	5	56
213059	IT-C-7-1	5	56
213066	IT-C-7-1	5	56
213180	IT-C-7-3	20	82
213325	IT-C-7-3	20	72
213825	IT-C-7-5	20	96
213826	IT-C-7-5	20	96
213829	IT-C-7-5	20	96
213830	IT-C-7-5	20	96
213831	IT-C-7-5	20	95
213832	IT-C-7-5	20	95
213833	IT-C-7-5	20	94
213834	IT-C-7-5	20	94
213961	IT-C-7-1	5	55
213962	IT-C-7-1	5	56
213964	IT-C-7-1	5	55
214013	IT-A-7-2-3-4	100	64
214014	IT-A-7-2-3-4	100	64
214016	IT-A-6-2-9	20	64
214407	IT-C-7-2	20	81
214408	IT-C-7-2	20	81
214409	IT-C-7-3	20	81
214455	IT-C-7-2	20	69,74

N <sup>o</sup>	Gruppo	 € (/00 = 100 pz.)	Pagina
214456	IT-C-7-2	20	69,74
214458	IT-C-7-3	20	70,75
214459	IT-C-7-3	20	70,75
214693	IT-C-7-2	20	82
214694	IT-C-7-2	20	82
215197	IT-C-7-2	20	76
215201	IT-C-7-2	20	76
215376	IT-C-7-1	5	55
215377	IT-C-7-1	5	56
215380	IT-C-7-1	5	55
215381	IT-C-7-1	5	56
215382	IT-C-7-1	5	56
215497	IT-C-7-3	20	76
215785	IT-C-7-3	20	83
216754	IT-C-7-3	20	82
216755	IT-C-7-3	20	82
216863	IT-C-7-3	20	70
216864	IT-C-7-3	20	70
216865	IT-C-7-3	20	75
216866	IT-C-7-3	20	75
216981	IT-C-7-3	20	80
217584	IT-A-1-9-8	20	100
217676	IT-C-7-3	20	76
218784	IT-C-7-4	5	77
218785	IT-C-7-4	5	77
218901	IT-C-7-2	20	69,74
218902	IT-C-7-2	20	69,74
218903	IT-C-7-2	20	66
218904	IT-C-7-2	20	66
218977	IT-A-6-2-9	100	64
218978	IT-A-6-2-9	100	64
219036	IT-C-7-2	20	81
219037	IT-C-7-2	20	81
219038	IT-C-7-4	5	80
219039	IT-C-7-4	5	80
219040	IT-C-7-4	5	80
219041	IT-C-7-4	5	80
219042	IT-C-7-4	5	80
219043	IT-C-7-4	5	80
219183	IT-C-7-2	20	80
219184	IT-C-7-2	20	80
219231	IT-C-7-2	20	66
219232	IT-C-7-2	20	66
219233	IT-C-7-2	20	71
219234	IT-C-7-2	20	71
219235	IT-C-7-2	20	68
219236	IT-C-7-2	20	68
219258	IT-C-7-2	20	76
219259	IT-C-7-2	20	76
219260	IT-C-7-3	20	76
219269	IT-C-7-3	20	84
219513	IT-C-7-5	20	94
219514	IT-C-7-5	20	94
219515	IT-C-7-5	20	94
219516	IT-C-7-5	20	94
219517	IT-C-7-5	20	94
219518	IT-C-7-5	20	94
219519	IT-C-7-5	20	95
219520	IT-C-7-5	20	95
219521	IT-C-7-5	20	95
219522	IT-C-7-5	20	95
219523	IT-C-7-5	20	95
219524	IT-C-7-5	20	95
221097	IT-C-7-5	20	95
222201	IT-A-6-1-1	50	64,88
222208	IT-A-6-1-8	50	88
224409	IT-C-7-2	20	84
224410	IT-C-7-2	20	84
224649	IT-C-7-4	5	77
224650	IT-C-7-4	5	77
224651	IT-C-7-4	5	77
224652	IT-C-7-4	5	77
225092	IT-A-6-2-9	20	64
226489	IT-C-7-2	20	76

N <sup>o</sup>	Gruppo	 € (/00 = 100 pz.)	Pagina
226490	IT-C-7-2	20	76
226733	IT-C-7-4	5	77
226734	IT-C-7-4	5	77
226810	IT-C-7-2	20	69,74
226811	IT-C-7-2	20	69,74
227065	IT-C-7-3	20	70,75
227538	IT-S-1	20	23,33
228443	IT-C-7-2	20	84
228444	IT-C-7-2	20	84
228445	IT-C-7-3	20	84
228850	IT-C-7-3	20	84
229381	IT-C-7-8	20	33
229382	IT-C-7-8	20	33
229383	IT-C-7-8	20	33
229384	IT-C-7-8	20	33
229773	IT-C-7-1	5	21
229774	IT-C-7-1	5	21
229775	IT-C-7-1	5	21
229776	IT-C-7-1	5	21
229777	IT-C-7-1	5	21
230530	IT-C-9	5	41
230531	IT-C-9	5	41
230532	IT-C-9	5	41
230533	IT-C-9	5	41
230534	IT-C-9	5	41
230535	IT-C-9	5	41
230537	IT-C-9	5	41
230540	IT-C-9	5	41
230541	IT-C-9	5	41
230542	IT-C-9	5	41
230543	IT-C-9	5	41
230544	IT-C-9	5	41
230545	IT-C-9	5	41
230547	IT-C-9	5	41
230550	IT-C-9	5	41
230551	IT-C-9	5	41
230552	IT-C-9	5	41
230553	IT-C-9	5	41
230554	IT-C-9	5	41
230555	IT-C-9	5	41
230557	IT-C-9	5	41
230562	IT-C-9	5	39
230563	IT-C-9	5	39
230564	IT-C-9	5	39
230565	IT-C-9	5	39
230567	IT-C-9	5	39
230632	IT-C-9	5	40
230633	IT-C-9	5	40
230634	IT-C-9	5	40
230635	IT-C-9	5	40
230637	IT-C-9	5	40
230642	IT-C-9	5	40
230643	IT-C-9	5	40
230644	IT-C-9	5	40
230645	IT-C-9	5	40
230647	IT-C-9	5	40
230690	IT-C-4-1-3	5	49
230691	IT-C-4-1-3	5	49
230692	IT-C-4-1-3	5	49
230693	IT-C-4-1-3	5	49
230694	IT-C-4-1-3	5	49
230695	IT-C-4-1-3	5	49
230696	IT-C-4-1-3	5	49
230697	IT-C-4-1-3	5	49
230760	IT-C-4-2-3	5	49
230761	IT-C-4-2-3	5	49
230762	IT-C-4-2-3	5	49
230763	IT-C-4-2-3	5	49
230764	IT-C-4-2-3	5	49
230765	IT-C-4-2-3	5	49
230767	IT-C-4-2-3	5	49
231410	IT-C-9	5	39
231411	IT-C-9	5	39
231412	IT-C-9	5	39

No	Gruppo		€ (/100 = 100 pz.)	Pagina
231413	IT-C-9	5		39
231414	IT-C-9	5		39
231415	IT-C-9	5		39
231450	IT-C-9	5		39
231451	IT-C-9	5		39
231452	IT-C-9	5		39
231453	IT-C-9	5		39
231454	IT-C-9	5		39
231455	IT-C-9	5		39
231490	IT-C-9	5		39
231491	IT-C-9	5		39
231492	IT-C-9	5		39
231493	IT-C-9	5		39
231494	IT-C-9	5		39
231495	IT-C-9	5		39
231540	IT-C-9	5		41
231541	IT-C-9	5		41
231542	IT-C-9	5		41
231543	IT-C-9	5		41
231544	IT-C-9	5		41
231550	IT-C-9	5		42
231551	IT-C-9	5		42
231552	IT-C-9	5		42
231553	IT-C-9	5		42
231554		5		42
231570	IT-C-9	5		42
231571	IT-C-9	5		42
231572	IT-C-9	5		42
231573	IT-C-9	5		42
231574	IT-C-9	5		42
232010	IT-C-2-1-3	5		59
232011	IT-C-2-1-3	5		59
232012	IT-C-2-1-3	5		59
232013	IT-C-2-1-3	5		59
232014	IT-C-2-1-3	5		59
232015	IT-C-2-1-3	5		59
232017	IT-C-2-1-3	5		59
232330	IT-C-9	5		40
232331	IT-C-9	5		40
232332	IT-C-9	5		40
232340	IT-C-9	5		40
232341	IT-C-9	5		40
232342	IT-C-9	5		40
232350	IT-C-9	5		40
232351	IT-C-9	5		40
232352	IT-C-9	5		40
234000	IT-C-4-1-B	5		52
234001	IT-C-4-1-B	5		52
234002	IT-C-4-1-B	5		52
234003	IT-C-4-1-B	5		52
234004	IT-C-4-1-B	5		52
234180	IT-C-4-1-3	5		49
234181	IT-C-4-1-3	5		49
235122	IT-C-4-2-2	5		52
235123	IT-C-4-2-2	5		52
235124	IT-C-4-2-2	5		52
235810	IT-C-4-1-B	5		51
235811	IT-C-4-1-B	5		51
235812	IT-C-4-1-B	5		51
235813	IT-C-4-1-B	5		51
235814	IT-C-4-1-B	5		51
235815	IT-C-4-1-B	5		51
235816	IT-C-4-1-B	5		51
235817	IT-C-4-1-B	5		51
235852	IT-C-4-2-B	5		51
235853	IT-C-4-2-B	5		51
235854	IT-C-4-2-B	5		51
235855	IT-C-4-2-B	5		51
235856	IT-C-4-2-B	5		51
235857	IT-C-4-2-B	5		51
235890	IT-C-4-3-B	5		51
235891	IT-C-4-3-B	5		51
235892	IT-C-4-3-B	5		51
235893	IT-C-4-3-B	5		51

No	Gruppo		€ (/100 = 100 pz.)	Pagina
235894	IT-C-4-3-B	5		51
236600	IT-C-4-4-7	5		52
236601	IT-C-4-4-7	5		52
236602	IT-C-4-4-7	5		52
236603	IT-C-4-4-7	5		52
236604	IT-C-4-4-7	5		52
23731	IT-A-1-9-4	100		72
237600	IT-C-4-3-3	5		49
237601	IT-C-4-3-3	5		49
237602	IT-C-4-3-3	5		49
237603	IT-C-4-3-3	5		49
237604	IT-C-4-3-3	5		49
237605	IT-C-4-3-3	5		49
237620	IT-C-4-3-B	5		51
237621	IT-C-4-3-B	5		51
237622	IT-C-4-3-B	5		51
237623	IT-C-4-3-B	5		51
237624	IT-C-4-3-B	5		51
237625	IT-C-4-3-B	5		51
237626		5		51
238560	IT-C-4-1-C	5		50
238561	IT-C-4-1-C	5		50
238562	IT-C-4-1-C	5		50
238563	IT-C-4-1-C	5		50
238564	IT-C-4-1-C	5		50
238565	IT-C-4-1-C	5		50
23883	IT-A-1-9-4	100		67
23886	IT-A-1-9-4	100		72
245000	IT-C-B-1-1	5		17
245001	IT-C-B-1-1	5		17
245002	IT-C-B-1-1	5		17
245003	IT-C-B-1-1	5		17
245004	IT-C-B-1-1	5		17
245006	IT-C-B-1-1	5		17
245007	IT-C-B-1-1	5		17
245008	IT-C-B-1-1	5		17
245012	IT-C-B-1-2	5		17
245013	IT-C-B-1-2	5		17
245014	IT-C-B-1-2	5		17
245016	IT-C-B-1-2	5		17
245017	IT-C-B-1-2	5		17
245018	IT-C-B-1-2	5		17
245020	IT-C-B-1-3	5		18
245021	IT-C-B-1-3	5		18
245022	IT-C-B-1-3	5		18
245023	IT-C-B-1-3	5		18
245024	IT-C-B-1-3	5		18
245030	IT-C-B-1-3	5		19
245031	IT-C-B-1-3	5		19
245032	IT-C-B-1-3	5		19
245033	IT-C-B-1-3	5		19
245034	IT-C-B-1-3	5		19
245036	IT-C-B-1-3	5		19
245037	IT-C-B-1-3	5		19
245038	IT-C-B-1-3	5		19
245040	IT-C-B-1-4	5		19
245041	IT-C-B-1-4	5		19
245042	IT-C-B-1-4	5		19
245043	IT-C-B-1-4	5		19
245044	IT-C-B-1-4	5		19
245140	IT-C-B-1-1	5		17
245141	IT-C-B-1-1	5		17
245142	IT-C-B-1-1	5		17
245143	IT-C-B-1-1	5		17
245144	IT-C-B-1-1	5		17
245146	IT-C-B-1-1	5		17
245147	IT-C-B-1-1	5		17
245148	IT-C-B-1-1	5		17
245152	IT-C-B-1-2	5		18
245154	IT-C-B-1-2	5		18
245156	IT-C-B-1-2	5		18
245157	IT-C-B-1-2	5		18
245158	IT-C-B-1-2	5		18
245160	IT-C-B-1-3	5		18

<b>Nº</b>	<b>Gruppo</b>	 <b>€</b> (/00 = 100 pz.)	<b>Pagina</b>
245161	IT-C-B-1-3	5	18
245162	IT-C-B-1-3	5	18
245164	IT-C-B-1-3	5	18
245170	IT-C-B-1-3	5	19
245171	IT-C-B-1-3	5	19
245172	IT-C-B-1-3	5	19
245173	IT-C-B-1-3	5	19
245174	IT-C-B-1-3	5	19
245176	IT-C-B-1-3	5	19
245177	IT-C-B-1-3	5	19
245178	IT-C-B-1-3	5	19
245180	IT-C-B-1-4	5	20
245181	IT-C-B-1-4	5	20
245182	IT-C-B-1-4	5	20
245183	IT-C-B-1-4	5	20
245184	IT-C-B-1-4	5	20
245280	IT-C-B-1-1	5	17
245283	IT-C-B-1-1	5	17
245284	IT-C-B-1-1	5	17
245286	IT-C-B-1-1	5	17
245292	IT-C-B-1-2	5	18
245304	IT-C-B-1-3	5	18
245310	IT-C-B-1-3	5	19
245311	IT-C-B-1-3	5	19
245312	IT-C-B-1-3	5	19
245320	IT-C-B-1-4	5	20
245321	IT-C-B-1-4	5	20
245322	IT-C-B-1-4	5	20
245323	IT-C-B-1-4	5	20
245324	IT-C-B-1-4	5	20
245514	IT-C-F	1	28
245516	IT-C-F	1	28
245518	IT-C-F	1	28
245520	IT-C-F	1	29
245521	IT-C-F	1	29
245522	IT-C-F	1	29
245530	IT-C-F	1	28
245531	IT-C-F	1	28
245532	IT-C-F	1	28
245533	IT-C-F	1	28
245534	IT-C-F	1	28
245536	IT-C-F	1	28
245538	IT-C-F	1	28
245540	IT-C-F	1	30
245541	IT-C-F	1	30
245542	IT-C-F	1	30
245543	IT-C-F	1	30
245544	IT-C-F	1	30
245654	IT-C-F	1	29
245656	IT-C-F	1	29
245658	IT-C-F	1	29
245660	IT-C-F	1	29
245661	IT-C-F	1	29
245662	IT-C-F	1	29
245670	IT-C-F	1	28
245671	IT-C-F	1	28
245672	IT-C-F	1	28
245673	IT-C-F	1	28
245674	IT-C-F	1	28
245676	IT-C-F	1	28
245678	IT-C-F	1	28
245680	IT-C-F	1	30
245681	IT-C-F	1	30
245682	IT-C-F	1	30
245683	IT-C-F	1	30
245684	IT-C-F	1	30
245820	IT-C-F	1	30
245821	IT-C-F	1	30
245822	IT-C-F	1	30
245823	IT-C-F	1	30
245824	IT-C-F	1	30
250461	IT-C-7-8	20	33
250462	IT-C-7-8	20	33
250508	IT-C-7-2	20	83

<b>Nº</b>	<b>Gruppo</b>	 <b>€</b> (/00 = 100 pz.)	<b>Pagina</b>
250509	IT-C-7-2	20	83
250510	IT-C-7-3	20	83
250593	IT-C-7-8	20	33
250970	IT-C-7-4	5	88
250971	IT-C-7-4	5	88
251393	IT-C-7-4	5	87
251394	IT-C-7-4	5	87
251395	IT-C-7-4	5	87
251396	IT-C-7-4	5	87
251397	IT-C-7-4	5	87
251398	IT-C-7-4	5	87
251405	IT-C-7-4	5	87
251406	IT-C-7-4	5	87
251407	IT-C-7-4	5	87
251416	IT-C-7-4	5	87
251417	IT-C-7-4	5	87
251418	IT-C-7-4	5	87
251419	IT-C-7-4	5	87
251420	IT-C-7-4	5	87
251421	IT-C-7-4	5	87
251427	IT-C-7-4	5	87
251428	IT-C-7-4	5	87
251429	IT-C-7-4	5	87
251430	IT-C-7-4	5	87
251431	IT-C-7-4	5	87
251432	IT-C-7-4	5	87
251446	IT-C-7-4	5	87
251447	IT-C-7-4	5	87
251448	IT-C-7-4	10	89
251454	IT-C-7-4	5	89
251461	IT-C-7-4	10	90
251462	IT-C-7-4	10	90
251463	IT-C-7-4	10	89
251464	IT-C-7-4	10	89
251465	IT-C-7-4	10	89
251466	IT-C-7-4	5	89
251471	IT-C-7-4	10	89
251472	IT-C-7-4	10	89
251473	IT-C-7-4	10	91
251474	IT-C-7-4	5	91
251477	IT-C-7-4	5	91
251484	IT-C-7-4	10	91
251485	IT-C-7-4	10	91
251486	IT-C-7-4	5	91
251488	IT-C-7-4	5	91
251489	IT-C-7-4	5	91
251490	IT-C-7-4	10	91
251491	IT-C-7-4	10	91
251492	IT-C-7-4	5	91
251494	IT-C-7-4	5	91
251495	IT-C-7-4	5	91
251635	IT-C-7-4	5	82
251636	IT-C-7-4	5	82
251647	IT-C-7-4	10	89
251648	IT-C-7-4	5	89
251674	IT-C-7-2	20	82
251675	IT-C-7-2	20	82
251680	IT-C-7-4	5	82
251681	IT-C-7-4	5	82
251682	IT-C-7-4	5	82
251683	IT-C-7-4	5	82
260270	IT-C-4-1-E	5	50
260271	IT-C-4-1-E	5	50
260272	IT-C-4-1-E	5	50
260273	IT-C-4-1-E	5	50
260274	IT-C-4-1-E	5	50
260275	IT-C-4-1-E	5	50
260360	IT-C-4-1-6	5	49
260361	IT-C-4-1-6	5	49
260362	IT-C-4-1-6	5	49
260363	IT-C-4-1-6	5	49
260364	IT-C-4-1-6	5	49
260365	IT-C-4-1-6	5	49
260413	IT-C-B-1-2	5	18

<b>No</b>	<b>Gruppo</b>		<b>€</b> (/100 = 100 pz.)	<b>Pagina</b>
260531	IT-C-B-1-1	5		17
260532	IT-C-B-1-1	5		17
260537	IT-C-B-1-1	5		17
260538	IT-C-B-1-1	5		17
260543	IT-C-B-1-2	5		18
260544	IT-C-B-1-2	5		18
260546	IT-C-B-1-2	5		18
260547	IT-C-B-1-2	5		18
260548	IT-C-B-1-2	5		18
260550	IT-C-B-1-3	5		18
260551	IT-C-B-1-3	5		18
260552	IT-C-B-1-3	5		18
260563	IT-C-B-1-3	5		19
260564	IT-C-B-1-3	5		19
260566	IT-C-B-1-3	5		19
260567	IT-C-B-1-3	5		19
260568	IT-C-B-1-3	5		19
261394	IT-C-F	1		29
261396	IT-C-F	1		29
261400	IT-C-F	1		29
261401	IT-C-F	1		29
261402	IT-C-F	1		29
261410	IT-C-F	1		28
261411	IT-C-F	1		28
261412	IT-C-F	1		28
261413	IT-C-F	1		28
261414	IT-C-F	1		28
261416	IT-C-F	1		28
261418	IT-C-F	1		28
26617	IT-C-7-3	20		72
26755	IT-A-1-9-4	100		72
26799	IT-C-7-3	20		67
28603	IT-S-1	1		102
29776	IT-C-7-2	50		66
29787	IT-C-7-2	50		68,73

**3**

30545	IT-A-1-9-1	200		66
34004	IT-C-7-3	50		68
34606	IT-A-1-9-1	200		76
34610	IT-A-1-9-1	200		76
34934	IT-A-1-9-1	200		74
34943	IT-A-1-9-1	200		71
34969	IT-A-1-9-1	200		71
34979	IT-A-1-9-1	200		71
34980	IT-A-1-9-1	200		71
34981	IT-A-1-9-1	200		73
35250	IT-C-7-3	50		76
354358	IT-C-7-6	100		99
354952	IT-C-7-2	20		66
354954	IT-C-7-2	20		66
354987	IT-C-7-3	20		76
355000	IT-C-7-3	20		76
355399	IT-C-7-6	50		99
356361	IT-A-1-9-8	100		83
356362	IT-A-1-9-1	200		83
357671	IT-A-1-9-1	200		69
357672	IT-A-1-9-1	200		69
357673	IT-A-1-9-8	100		69
357674	IT-A-1-9-8	100		69
358024	IT-C-7-3	50		99
358027	IT-C-7-6	50		99
360074	IT-C-7-6	100		99
360102	IT-A-1-9-8	100		69
360103	IT-A-1-9-8	100		69
360112	IT-C-7-2	20		66
360113	IT-C-7-2	20		66
360159	IT-C-7-6	20		99
360397	IT-C-7-6	50	98,99	
360614	IT-C-7-2	20		69
360615	IT-C-7-2	20		69
360693	IT-A-1-9-1	200		84
360694	IT-A-1-9-8	100		84
361453	IT-C-7-3	100		83

<b>No</b>	<b>Gruppo</b>		<b>€</b> (/100 = 100 pz.)	<b>Pagina</b>
362002	IT-C-7-3	20		67,68
362704	IT-C-7-6	100		99
362906	IT-C-7-8	50		100
362920	IT-C-7-6	100		99
363473	IT-C-B-3	1		23,32
364770	IT-C-7-7	20		99
364771	IT-C-7-7	20		99
364952	IT-A-1-9-8	100		74
364953	IT-A-1-9-8	100		74
367505	IT-A-1-9-8	20		100
367722	IT-A-1-9-8	20		100
367738	IT-A-1-9-8	20		100
368014	IT-A-1-9-8	20		100
369691	IT-C-7-6	100		99
372697	IT-C-7-7	20		99
373147	IT-C-7-8	10		33
373646	IT-C-B-3	20		24,34
38924	IT-C-7-3	50		72

**4**

40720	IT-S-1	20		100
43524	IT-C-7-2	50		99
43586	IT-C-7-8	50		100
43718	IT-A-1-B-9	100		99
44205	IT-A-1-B-8	100		99
44206	IT-A-1-B-8	100		99
44253	IT-C-7-6	50		99
44268	IT-A-1-B-8	100		99
44316	IT-A-1-B-8	100		99
44372	IT-C-7-6	50		99
44373	IT-C-7-6	50		99
453541	IT-U-5	1		100
457573	IT-C-7-5	20		94
460342	IT-C-7-6	100		99
461742	IT-S-1	1		102
463945	IT-S-1	1		102
463946	IT-S-1	1		102
463947	IT-S-1	1		102
466833	IT-C-B-3	1		23,32
466834	IT-C-B-3	1		23,32
466835	IT-C-B-3	1		23,32
466836	IT-C-B-3	1		23,32
466837	IT-C-B-3	1		23,32
466838	IT-C-B-3	1		23,32
466842	IT-C-B-3	1		23,32
467734	IT-S-1	1		102
476515	IT-C-B-3	1		22,31
477428	IT-C-B-3	100		101
477536	IT-C-B-3	1		101
478181	IT-C-B-3	1		22,31
478679	IT-C-7-8	1		98
478680	IT-C-B-3	1		101
478682	IT-C-B-3	1		101
478684	IT-C-B-3	1		24,33,101
478686	IT-C-B-3	1		24,33,101
478687	IT-C-B-3	1		24,33,101
478819	IT-C-B-3	1		24,34
478821	IT-C-B-3	1		24,34
480259	IT-C-B-3	1		22,31
480276	IT-C-B-3	1		23,32
480277	IT-C-B-3	1		23,32
480489	IT-C-B-3	1		22,31
480987	IT-C-B-3	1		23,32
481124	IT-C-B-3	1		22,31
481452	IT-C-B-3	1		23,32

**5**

50576	IT-C-7-3	20		67
50579	IT-C-7-3	20		72,83
55112	IT-A-1-9-4	100		67
55252	IT-C-7-3	50		72
55985	IT-C-7-5	20		94,95,96
55986	IT-C-7-3	20		72
55987	IT-C-7-2	50		71
55989	IT-C-7-5	20		94,95,96

<b>N°</b>	<b>Gruppo</b>	 <b>€</b> (/100 = 100 pz.)	<b>Pagina</b>
55993	IT-C-7-1	10	53
57824	IT-C-7-1	10	53
57825	IT-C-7-1	10	53
57826	IT-C-7-1	10	53
57827	IT-C-7-1	10	53
57915	IT-T-1	20	96
57916	IT-T-1	20	96
58029	IT-T-1	20	96
58030	IT-T-1	20	96
58107	IT-C-7-1	10	53
58464	IT-C-7-5	20	94,95,96
58465	IT-T-1	20	96
58468	IT-C-7-5	20	94,95,96
58469	IT-T-1	20	96
58574	IT-C-7-5	20	95
58575	IT-C-7-5	20	95
58608	IT-C-7-5	20	95
58609	IT-C-7-5	20	95
58646	IT-C-7-2	50	71
58647	IT-C-7-2	50	71
58648	IT-C-7-2	50	71
58649	IT-C-7-2	20	71
58667	IT-C-7-3	20	72
58674	IT-C-7-2	50	76
58675	IT-C-7-2	50	76
58714	IT-C-7-2	50	76
58715	IT-C-7-2	50	76
59424	IT-C-7-5	20	94
59425	IT-C-7-5	20	94
59428	IT-C-7-5	20	95
59429	IT-C-7-5	20	95
59430	IT-C-7-5	20	95
59431	IT-C-7-5	20	95
<b>9</b>			
94118	IT-C-7-3	50	67
94219	IT-A-1-B-9	100	100
94322	IT-C-7-3	50	72
94463	IT-A-1-9-1	200	76
96264	IT-A-1-9-8	100	71
96305	IT-A-1-9-8	100	66
96306	IT-A-1-9-8	100	66
96558	IT-A-1-9-8	100	76
96561	IT-A-1-9-8	100	73
96563	IT-A-1-9-8	100	71
96564	IT-A-1-9-8	100	71
96565	IT-A-1-9-8	100	66
96566	IT-A-1-9-8	100	66
96660	IT-A-1-9-8	100	71
96845	IT-A-1-9-8	100	68
96846	IT-A-1-9-8	100	68
96860	IT-A-1-9-8	100	71
96861	IT-A-1-9-8	100	73
<b>K</b>			
K702501	IT-U-4-2	1	71
K702505	IT-U-4-2	1	71
<b>X</b>			
X801920	IT-S-1	1	102
X928705	IT-S-1	1	102

**MACO  
PROTECT**



Indice articoli

# Tutto da un unico fornitore

Da noi trovi soluzioni complete per finestre, porte e scorrevoli – per legno, PVC e alluminio. Prova la nostra variegata gamma di sistemi e la completezza dei nostri servizi. Scopri di più su **www.maico.com** o contatta il tuo consulente Maico. Seguici sui social media per conoscere le ultime novità.

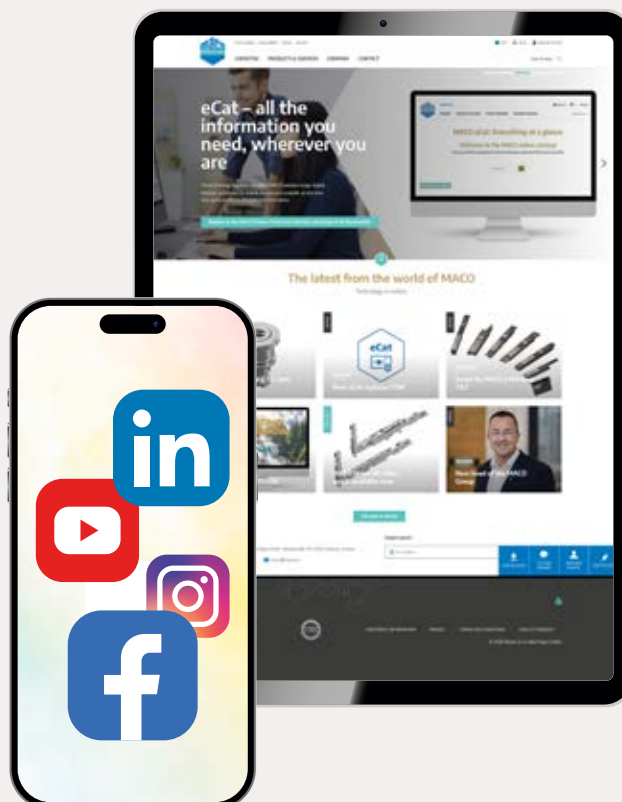

MAICO SRL

Via dei Legnai 15 · I-39015 S. Leonardo (BZ) · Tel +39 0473 65 12 00 · info@maico.com



VALORIZZIAMO  
IL SERRAMENTO