

TEHNIKA KI PREMIKA

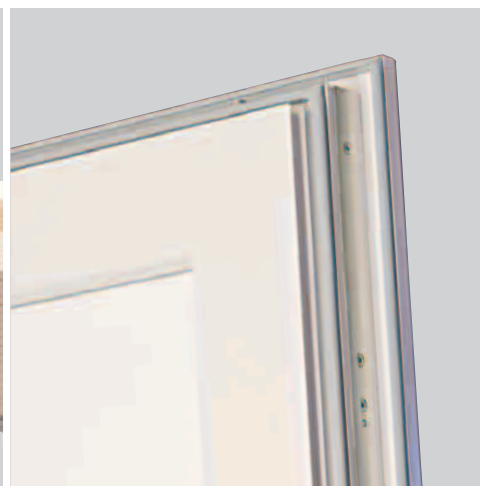

MACO TESNILA

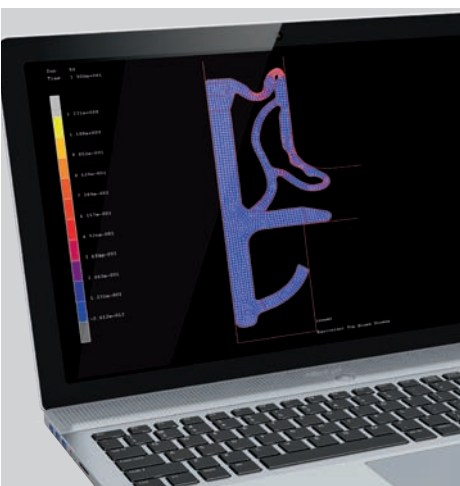

Katalog

MACO
TESNILA





1	Informacije	5
<hr/>		
2	okno	8
<hr/>		
3	vrata	29
<hr/>		
4	HS	43
<hr/>		
5	Index	47
<hr/>		



N^o številka artikla



embalažne enote



brutocena v € (/₀₀ pomeni da se cena nanaša na 100 kom, drugače je vedno cena za 1 kom.



način obdelave



celotna deljiva dolžina



širina talnega tesnila



višina talnega tesnila



zrak, kateri bo pokriti iz strani talnega tesnila



širina



višina



1 Informacije

1.1 Navodila za odgovornost proizvoda

1. Informacije o proizvodu in uporabo po predpisih

Tesnila zajemajo naslednje ponudbe proizvodov

- tesnila za okna
- tesnila za vrata
- dodatki za tesnila oken in vrat
- talna tesnila
- dodatki za talna tesnila

Uporabno območje

Vsi nadaljni detajli za pravilno tehnično uporabo so v segmentih MATERIJALNIH LASTNOSTIH, LASTNOSTI O TESNILIH, OBDELOVALNE METODE ZA TESNILA, TEHNIČNE LASTNOSTI O TESNILIH ZA PRISLON PRAGA NA VRATA v predloženih MACO-katalogih označeni (glej točko 5 predloženega dokumenta).

2. Prosim upoštevajte

- Posebne opombe
- i. Serijski proizvodi tesnil so namenjeni samo profesionalni uporabi.
- ii. MACO zavrača vsako odgovornost za napake pri vgradnji, škode ali pomanjkljivosti, katere so v realizaciji uporabe ali vgradnje, bile od nestrokovne ali kvalificirte osebe vgrajene

3. Nepravilna uporaba

Vsak prejemnik dobavljenih proizvodov, t.p.vsi, kateri proizvod prejemajo, uporabijo, preprodajajo itd, so brez izjeme zavezani, k predpisom in navodilom predloženega tehničnega lista in tam navedenih dokumentov striktno upoštevati. Vsi prejemniki, zlasti osebe/poklicne skupine kateri so navedeni pod št. 4 tega tehničnega lista, morajo na podlagi svoje informacijske obveznosti dobavljenih proizvodov nasproti svojih strank, monterjev oz. uporabnikov proizvodov MACO ustrezno informirati. Poleg tega je še obvezno, pozornost nameniti dokumentu o vgradnji in uporabi raznih elementov v zvezi z skladiščenjem, uporabo, dostavo in ravnanjem proizvodov MACO. Posebno je potrebno tudi omeniti oškodovanja, katera lahko nastanejo pri napačni in nepravilni uporabi proizvodov MACO.

Pod nepravilno uporabo štejemo če:

- a) tesnila pridejo v stik z laki, katere vrsta in možno naknadno obnašanje ni poznano (razjasnite kompatibilnost pred uporabo z dobaviteljem)
- b) navodila za uporabo v montažnih navodilih niso bila upoštevana
- c) zahtevane PUZ (poklicna uporabna zaščita npr. rokavice, zaščitna očala, dihalne maske itd) pri uporabi kot navedeno v varnostnih navodilih niso bile upoštevane
- d) opombe v uporabnem območju, katere so navedene za določene proizvode niso bile upoštevane

4. Informacijska - in šolska naloga - opis ciljnih skupin

Uporaba predloženega dokumenta se naslanja samo za prejemnike proizvodov npr. brez izjeme vsi kateri ta proizvod dobi-jo, uporabljajo, preprodajajo itd. Za primer navajamo nekatere poklicne skupine :

4.1. Načrtovalec

zajema vsa podjetja/osebe, katera sodelujejo v planiranju gradnji zgradb in s tem povezanih vgradnji okenskih/vratnih/sistemov vključno z vgrajenimi materiali in proizvodi.

4.2. Grosisti

zajema vsa podjetja/osebe, katera repromaterijale od določenih proizvajalcev dobavljajo in jih brez sprememb oziroma predelava prodajo naprej

4.3. Proizvajalci okenskih/vratnih/sistemov

zajema vsa podjetja/osebe katera repromaterijale od določenih proizvajalcev prejemajo in v zvezi s tem te proizvode uporabijo ali vgradijo naprej, na okenskih/vratnih/sistemih

4.4. Grosisti gradbenih proizvodov/montažerji

grosisti gradbenih proizvodov so vsa navedena podjetja/osebe katera okenske/vratne/sisteme dobavljajo pri proizvajalcih, in jih brez kakršnihkoli sprememb prodajo naprej ali vgradijo na objektu.

Montažerji so vsa podjetja/osebe kateri okenske/vratne/sisteme kupijo od proizvajalca in jih brez kakršnihkoli sprememb vgradijo na objektu

4.5. Naročnik

zajema vsa podjetja/osebe katere naročijo okenske/vratne/sisteme pri proizvajalcu zaradi vgradnje le-teh na naročnikovem objektu.

4.6. Končna stranka/Uporabnik

zajema vse osebe katere okenske/vratne/sisteme uporabljajo. Takšne osebe imenujemo tudi uporabnik.

Z nemenom da informacije izpolnjujejo zahtevana navodila in razlage uporabe namenoma jamstvo MACO proizvodov v skladu z kodeksom o potrošniku odloka 206/2005 vsi prejemniki teh proizvodov na podlagi točke (5) predložene dokumentacije (v tako imenovani označeni proizvodni dokumentaciji) ne glede na ta kateri odsek v celotni dokumentaciji zajema to področje.

Prejemniki proizvodov so po svoji strani zavezani k branju vsih proizvodnih informacije po točki 15 tega dokumenta kakor tudi vzeti na znanje in se jih striktno držati, s tem se poslužujejo korektno uporabe in si zagotavljajo pravilno delovanje izdelka.

Primeri



- Načrtovalci so tretirani kot osebe katere informirajo naročnike oken/vrat na podlagi pridobitve aktualne verzije proizvodnih informacij MACO, katere se morajo tudi upoštevati (glej točko 5)
- Grosisti prodaje morajo priskrbeti aktualno verzijo informacije o proizvodih (glej točko 5) zlasti pri MACO tehničnih listih, montažnih navodilih, navodilih za uporabo in vzdrževanje in če ne drugače zahtevano tudi varnostna tehnična navodila, katera moraja biti dosegljiva proizvajalcem oken/vrat, katere se lahko tudi posredujejo montažerjem ali gradbenim podjetjem.
- Grosisti gradbenih proizvodov/montažerji so primorani, le to informacijo o proizvodu posredovati naprej (glej točko 5) zlasti pri dobaviteljnih okenskih/vratnih/sistemov kateri morajo navodila za vzdrževanje in uporabo predati na končnega naročnika.

5. Dosegljiva, dokumentacija katera se mora upoštevati

Naslednja dokumentacija zajema zavezujoči predpisi v primeru uporabe proizvodov TESNILA:

- I. katalog proizvodov
- II. montažni in uporabni načrt (če je predvideno)
- III. tehnični listi proizvodov
- IV. varnostni tehnični list (če je predviden)
- V. navodila za vgradno in vzdrževanje (če je predvideno)

Aktualna verzija zgoraj navedenih dokumentov se lahko naroči v tiskani obliki pri podjetju MACO ali pa se sname iz inetrnetne strani pod naslovom www.maco.com

6. Izključitev odgovornosti

Vse informacije in navodila v tem dokumentu so bili ustvarjeni z pomočjo tehnologije glede na izkušnje in znanja pridobljene z upoštevanjem veljavnih standardov in predpisov.

Za varnost in uporabo so vsa navodila v dokumentaciji pri uporabi proizvodov TESNILA (GLEJ TOČKO 2 IN 5) ki zagotavljajo varnost in primernost uporabe MACO prejemnikom proizvodov TESNILA. Neupoštevanje navodil ali zloraba le teh velja za riziko le tega osobja z določeno odgovornostjo po točki 3. Če se uporablja oziroma vgrajuje na podlagi odstopanja po specifikaciji proizvajalca kateri je uredil sistem, lahko avtomatično takšno preverjanje skladnosti preveri za to usposobljena oseba kateri pristojnost določi proizvajalec.

MACO je prav tako pri naslednjih predmetih izključen vsake odgovornosti:

- a) če je pomankljivost na osnovi zakona ali administracijskega predpisa, katerim ta proizvod ustreza
- b) če je na podlagi veljavnega strokovnega načela v tem trenutku uvajanje proizvoda na tržišče skozi katerega lastnosti se je možno pritoževati, se le to kot navedena napaka ne priznava.
- c) če pritoževalec naredi samo en element ali polizdelek in se napaka pokaže že v fazi konstrukcije proizvoda, v kaj ali katero je bil element ali polizdelek integriran, ali če se napaka pokaže na podlagi pomanjkljivosti od/ali uporabnika teh proizvodov TESNIL (glej točko 3) in ni bil sprejet določeni postopek v nastanku te napake.

MACO ne prevzema nobene odgovornosti za procesne ali dosežne napake ali škode če so le te povzročene na podlagi neupoštevanja točke 2,3e,5,6 (v posamičnih delih 2i, ii, iii, iv, 3a-e, 5 I,II,III,IV,V,VI, 6).

V tem primeru je vsaka zakonska ali pogodbeni garancija prav tako vsak način odgovornosti za škodo iz tega naslova povzročena izključena.

1.2 Materialeigenschaften

Tesnila iz penaste TPE-zmesi (TE)

Ta tesnila so iz termoplastičnega elastomera ali podobno troekstrudirana, pri katerem bo profil deloma penast.

- prvovrstni prevzem tolerance
- trdno, razteznotrajna zadnja stran za komfortno vgradnjo
- stabilna geometrija
- funkcijsko območje tesnila je iz penastega materiala za komfortno, mehko zapiranje na pritisk
- dobro ujemanje z laki na vodni bazi in razredčili
- lahko se vari ali v kotu izseka
- temperaturno obstojno: $-40/+120$ °C

Tesnila iz kompaktnega TPE (TC)

Iz termoplastičnega elastomera, mono - ali coekstrudirano.

- mogoča zelo tanko stenska geometrija profila - za maksimalen komfort in tiho zapiranje
- trdno, razteznotrajna zadnja stran za komfortno vgradnjo
- izvrstna dimenzijska stabilnost
- odličen prevzem tolerance
- dobro ujemanje z laki na vodni bazi in razredčili
- lahko se vari ali v kotu izseka
- temperaturno obstojno: $-40/+120$ °C

Tesnila iz kompaktnega silikona (SC)

Iz vulkaniziranega silikona, mono ali coekstrudirano.

- izvrstna odpornost proti ultra vijoličnim žarkom
- posebno mehki, komfortni zapirni pritisk tudi pri neugodno vrtljivi osi
- izboljšana zadnja vzdržljivost pri neugodnih vetrovih razmerah

- temperaturno obstojno: $-40/+120$ °C

Tesnila iz EPDM (EE,EC)

Ta tesnila so iz EPDM vulkanizirana in mono - ali coekstrudirana, pri čem je profil kompakten(EC) ali deloma penast (EE).

- (EE) funkcijsko območje tesnila je iz penastega materiala za komfortni in mehki zapirni pritisk
- (EC) tanko stenska profilna geometrija za visoko uporabo in dolgo življensko dobo
- odlična zadnja vzdržljivost
- odličen prevzem tolerance
- dobro ujemanje z laki na vodni bazi in razredčili
- v kotu izsekljivo
- temperaturno obstojno: $-40/+120$ °C

Tesnila iz kompaktnega Termoplasta (PC)

Iz mehkega vinilnega Termoplasta mono-ali-coekstrudirano

- primerna za kombinacijo z laki; razen za lake na vodni bazi
- lahko se vari ali v kotu izseka
- temperaturno obstojno: $-10/+70$ °C

Tesnila iz penastega silikona (SE)

ta tesnila so iz ekstrudirana iz vulkaniziranega silikona pri čem je profil deloma penast

- izvrstna odpornost proti ultra vijoličnim žarkom
- zelo mehka kakovost zahvaljujoč penastemu materialu
- izboljšana postavna vrednost pri zoprnih temperaturnih pogojih
- temperaturno obstojno: $-40/+200$ °C

2 okno

2.1 tesnila za utor v krilu

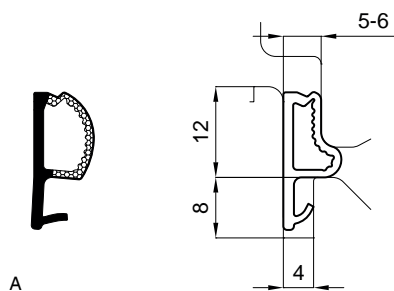
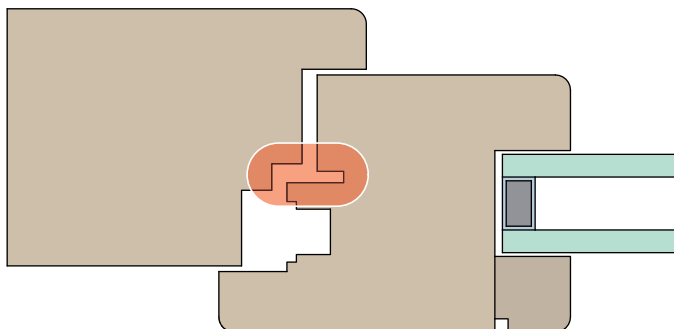

2.1.1 TE3003a-4

TE3003a-4		✂	L		№
TE3003a-4	bež	45°; TSS; 90°	170	170	476367*
	okensko siva	45°; TSS; 90°	170	170	A 476366*
	prometno bela	45°; TSS; 90°	170	170	476369*
	signalno črna	45°; TSS; 90°	170	170	476370
	sivo rjava	45°; TSS; 90°	170	170	476368*

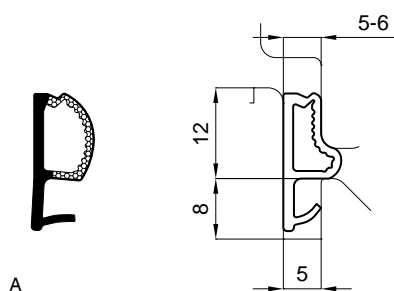

2.1.2 TE3003a-5

TE3003a-5		✂	L		№
TE3003a-5	bež	45°; TSS; 90°	170	170	476372*
	okensko siva	45°; TSS; 90°	170	170	A 476371*
	prometno bela	45°; TSS; 90°	170	170	476374*
	signalno črna	45°; TSS; 90°	200	170	476375
	sivo rjava	45°; TSS; 90°	170	170	476373*

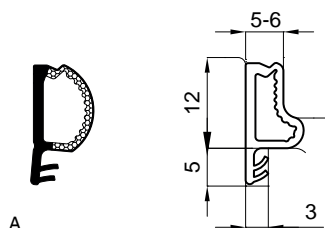

2.1.3 TE3004

				L		No
	TE3004	bež	45°; TSS	210	210	476570*
		okensko siva	45°; TSS	210	210	476567*
		prometno bela	45°; TSS	210	210	476569*
		signalno črna	45°; TSS	210	210	A 476566
		sivo rjava	45°; TSS	210	210	476568*

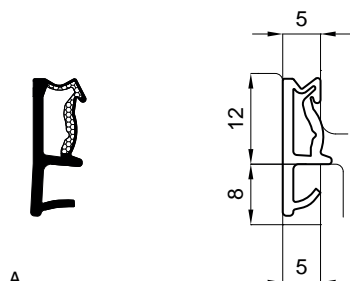

2.1.4 TE3009

				L		No
	TE3009	bež	45°; TSS; UNIV	200	200	A 476508
		okensko siva	45°; TSS; UNIV	200	200	476509*
		prometno bela	45°; TSS; UNIV	200	200	476511
		signalno črna	45°; TSS; UNIV	200	200	476512
		sivo rjava	45°; TSS; UNIV	200	200	476510

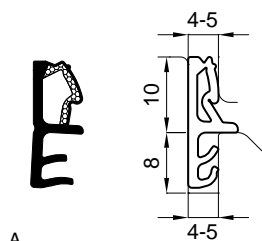

2.1.5 TE3011

				L		No
	TE3011	bež	45°; TSS; 90°	180	180	477399*
		okensko siva	45°; TSS; 90°	180	180	477400*
		prometno bela	45°; TSS; 90°	180	180	477397*
		signalno črna	45°; TSS; 90°	180	180	A 477396*
		sivo rjava	45°; TSS; 90°	180	180	477398*

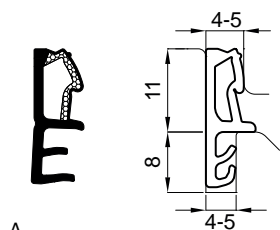

A

2.1.6	TE3013				L		No
	TE3013	prometno bela	45°; TSS; 90°	180	170		477891*
		signalno črna	45°; TSS; 90°	180	170	A	477889*
		sivo rjava	45°; TSS; 90°	180	170		477890*

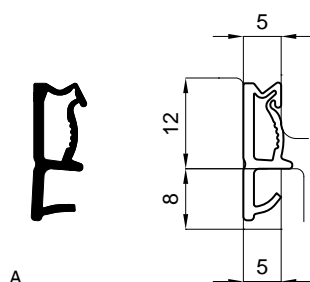

A

2.1.7	TC2002				L		No
	TC2002	bež	45°; TSS	200	200	A	476497*
		okensko siva	45°; TSS	200	200		476498*
		prometno bela	45°; TSS	200	200		476500*
		signalno črna	45°; TSS	200	200		476501
		sivo rjava	45°; TSS	200	200		476499*

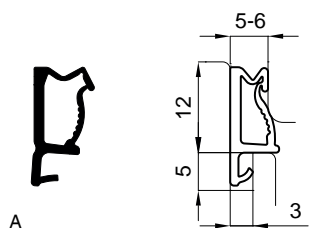

A

2.1.8	TC2003				L		No
	TC2003	bež		200	200	A	476634*
		okensko siva		200	200		476636*
		prometno bela		200	200		476637*
		signalno črna		200	200		476638
		sivo rjava		200	200		476635*
		svetlo siva		200	200		478047*

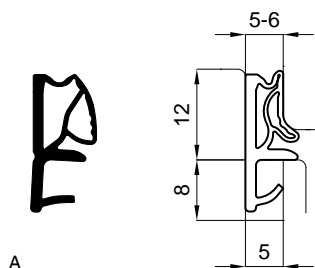

A

2.1.9 TC2017			L			N ^o
	TC2017				A	
		bež	45°; TSS	150	150	476690*
		okensko siva	45°; TSS	150	150	476692*
		prometno bela	45°; TSS	150	150	476693*
		signalno črna	45°; TSS	150	150	476694
		sivo rjava	45°; TSS	150	150	476691*

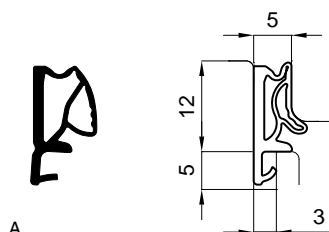

A

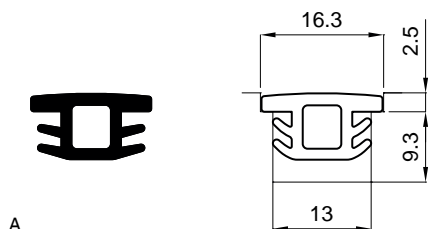

2.1.10 TC2018			L			N ^o
	TC2018				A	
		bež	45°; TSS	150	150	476695*
		okensko siva	45°; TSS	150	150	476697*
		prometno bela	45°; TSS	150	150	476698*
		signalno črna	45°; TSS	150	150	476699
		sivo rjava	45°; TSS	150	150	476696*

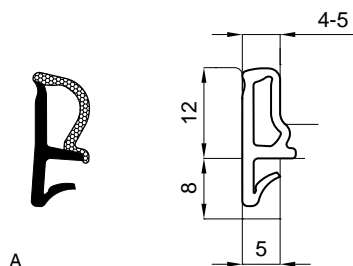

A

2.1.11 TC2025			L			N ^o
	TC2025				A	
		okensko siva	90°	180	180	477227



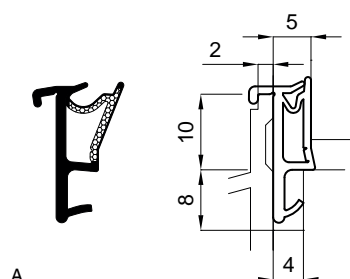
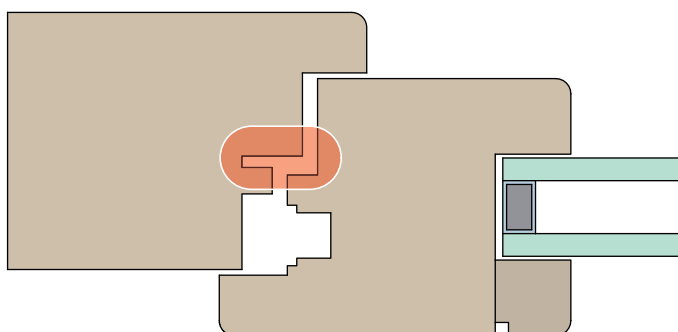

2.1.12 EE5002			L			N ^o
	EE5002	bež	45°	200	200	476889*
		okensko siva	45°	200	200	476887*
		prometno bela	45°	200	200	476886*
		signalno črna	45°	200	200	A 476885
		sivo rjava	45°	200	200	476888*

2.2 tesnila za podboj



A

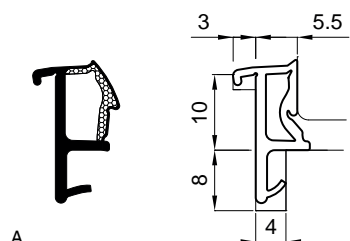

2.2.1 TE3002a

			L			N ^o
	TE3002a	bež	90°; UNIV	120	120	A 476482*
		okensko siva	90°; UNIV	120	120	476483*
		prometno bela	90°; UNIV	120	120	476485*
		signalno črna	90°; UNIV	120	120	476486*
		sivo rjava	90°; UNIV	120	120	476484*





A

2.2.2 TE3014

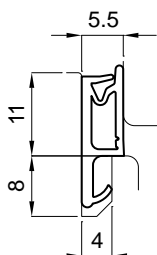
			L			N ^o
	TE3014	prometno bela	45°; TSS; 90°	120	120	477887*
		signalno črna	45°; TSS; 90°	120	120	A 477885*
		sivo rjava	45°; TSS; 90°	120	120	477886*



A

2.2.3	TE3015			L		No
	TE3015	bež	45°; TSS; UNIV	160	160	477992*
		prometno bela	45°; TSS; UNIV	160	160	477964*
		signalno črna	45°; TSS; UNIV	160	160	A 477962*
		sivo rjava	45°; TSS; UNIV	160	160	477991*
		svetlo siva	45°; TSS; UNIV	160	160	477990*

2.3 tesnila za preklap

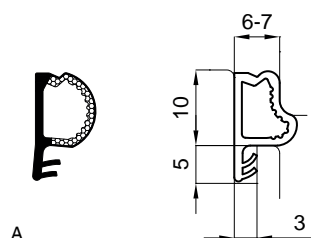
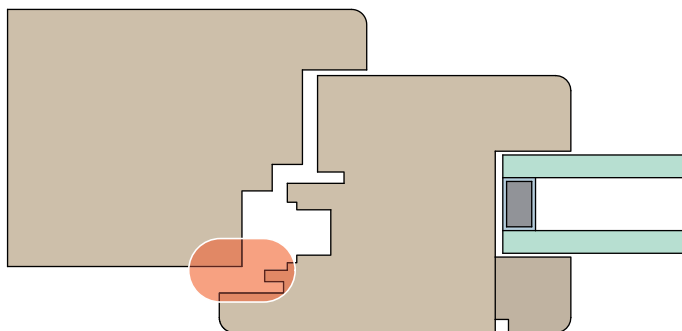

2.3.1 TE3001

		✂	L		N ^o
	TE3001		200	200	476377*
			200	200	A 476376*
			200	200	476379*
			200	200	476380
			200	200	476378*

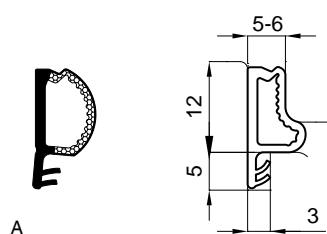

2.3.2 TE3004

		✂	L		N ^o
	TE3004		210	210	476570*
			210	210	476567*
			210	210	476569*
			210	210	A 476566
			210	210	476568*

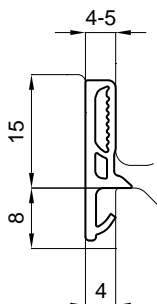

A

2.3.3	TE3005			✂	L		No
	TE3005	bež	90°; UNIV		170	170	476575*
		okensko siva	90°; UNIV		170	170	476572*
		prometno bela	90°; UNIV		170	170	476574*
		signalno črna	90°; UNIV		170	170	A 476571
		sivo rjava	90°; UNIV		170	170	476573*

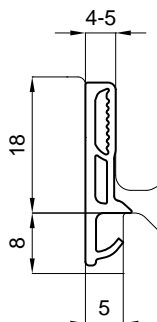

A

2.3.4	TE3006			✂	L		No
	TE3006	bež	90°; UNIV		170	170	476580*
		okensko siva	90°; UNIV		170	170	476577*
		prometno bela	90°; UNIV		170	170	476579*
		signalno črna	90°; UNIV		170	150	A 476576
		sivo rjava	90°; UNIV		170	170	476578*

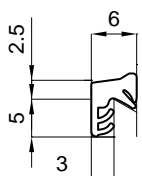

A

2.3.5	TE3007			✂	L		No
	TE3007	bež	45°; TSS		370	370	A 476487
		okensko siva	45°; TSS		370	370	476488*
		prometno bela	45°; TSS		370	370	476490
		signalno črna	45°; TSS		370	370	476491
		sivo rjava	45°; TSS		370	370	476489

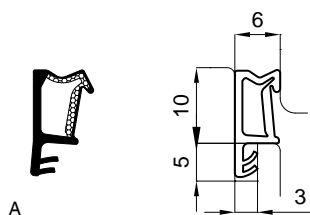

2.3.6 TE3008

				L		No	
	TE3008	bež	45°; TSS	230	230	A	476503*
		okensko siva	45°; TSS	230	230		476504*
		prometno bela	45°; TSS	230	230		476506*
		signalno črna	45°; TSS	230	230		476507
		sivo rjava	45°; TSS	230	230		476505*

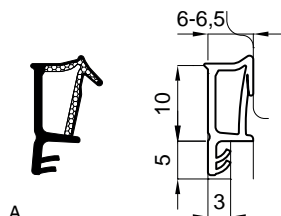

2.3.7 TE3012

				L		No	
	TE3012	bež	45°; TSS; 90°	190	190		477405*
		okensko siva	45°; TSS; 90°	190	190		477406*
		prometno bela	45°; TSS; 90°	190	190		477403*
		signalno črna	45°; TSS; 90°	190	190	A	477402*
		sivo rjava	45°; TSS; 90°	190	190		477404*

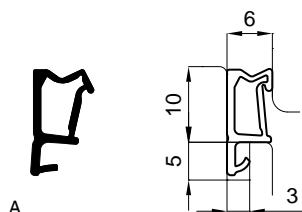

2.3.8 TC2001

				L		No	
	TC2001	bež	45°; TSS	230	230	A	476492*
		okensko siva	45°; TSS	230	230		476493*
		prometno bela	45°; TSS	230	230		476495*
		signalno črna	45°; TSS	230	230		476496
		sivo rjava	45°; TSS	230	230		476494*

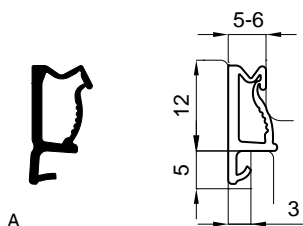

2.3.9 TC2003				L			No
	TC2003						
		bež		200	200	A	476634*
		okensko siva		200	200		476636*
		prometno bela		200	200		476637*
		signalno črna		200	200		476638
		sivo rjava		200	200		476635*
		svetlo siva		200	200		478047*

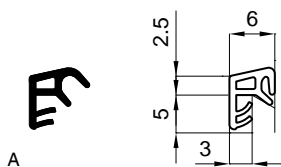

2.3.10 TC2004				L			No
	TC2004						
		bež	45°; TSS	370	370		476585*
		okensko siva	45°; TSS	370	370		476582*
		prometno bela	45°; TSS	370	370		476584*
		signalno črna	45°; TSS	370	370	A	476581
		sivo rjava	45°; TSS	370	370		476583*

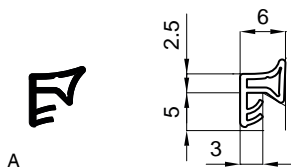

2.3.11 TC2005				L			No
	TC2005						
		bež	45°; TSS	370	370		476590*
		okensko siva	45°; TSS	370	370		476587*
		prometno bela	45°; TSS	370	370		476589*
		signalno črna	45°; TSS	370	370	A	476586
		sivo rjava	45°; TSS	370	370		476588*

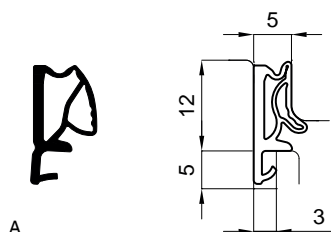

A

2.3.12 TC2018				L			N ^o
	TC2018	bež	45°; TSS	150	150	A	476695*
		okensko siva	45°; TSS	150	150		476697*
		prometno bela	45°; TSS	150	150		476698*
		signalno črna	45°; TSS	150	150		476699
		sivo rjava	45°; TSS	150	150		476696*

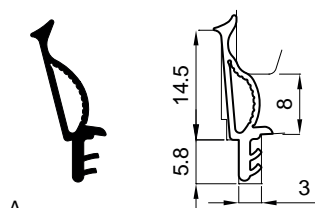

A

2.3.13 TC2027				L			N ^o
	TC2027	bež	45°; TSS; 90°	180	180		477411*
		okensko siva	45°; TSS; 90°	180	180		477412*
		prometno bela	45°; TSS; 90°	180	180		477409*
		signalno črna	45°; TSS; 90°	180	180	A	477408*
		sivo rjava	45°; TSS; 90°	180	180		477410*

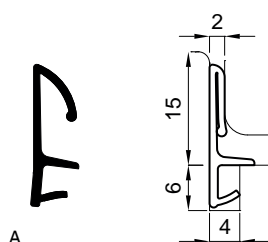

A

2.3.14 TC2028a				L			N ^o
	TC2028a	prometno bela	45°; TSS; 90°	200	200		477415*
		sivo rjava	45°; TSS; 90°	200	200	A	477414*

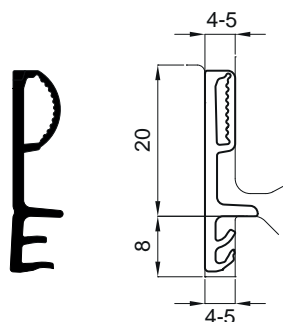

A

2.3.15 TC2029			✂	L		N ^o
	TC2029	bež	45°; TSS; 90°	140	140	477869*
		okensko siva	45°; TSS; 90°	140	140	477870*
		prometno bela	45°; TSS; 90°	140	140	477867*
		signalno črna	45°; TSS; 90°	140	140	A 477866*
		sivo rjava	45°; TSS; 90°	140	140	477868*

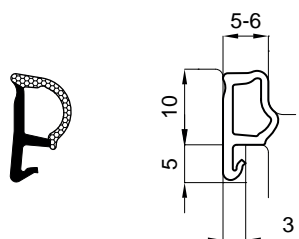

A

2.3.16 EE5001			✂	L		N ^o
	EE5001	bež	45°	220	220	476883*
		okensko siva	45°	220	220	476881*
		prometno bela	45°	220	220	476880*
		signalno črna	45°	220	220	A 476879
		sivo rjava	45°	220	220	476882*

2.4 čelna tesnila

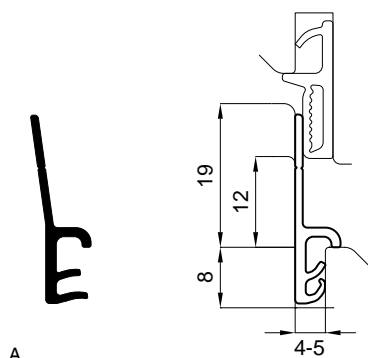
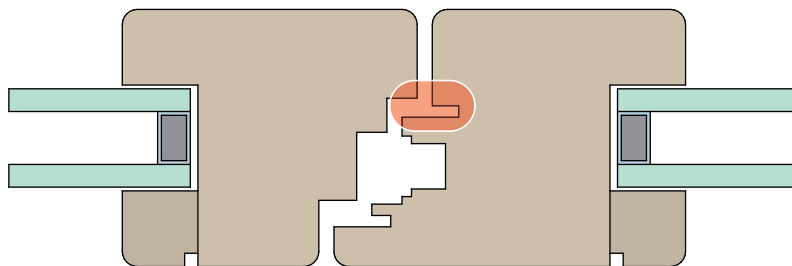

2.4.1 TC2019

			✂	L		№
	TC2019	bež	45°; TSS; 90°	180	180	476904
		okensko siva	45°; TSS; 90°	180	180	476902
		prometno bela	45°; TSS; 90°	180	180	476901
		signalno črna	45°; TSS; 90°	180	180	A 476900*
		sivo rjava	45°; TSS; 90°	180	180	476903

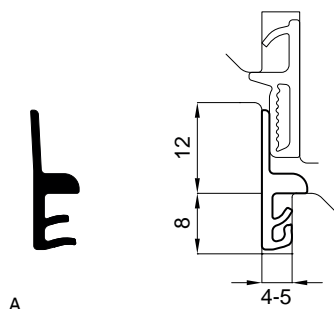

2.4.2 TC2020

				L		№
	TC2020	bež	45°; TSS; 90°	210	210	476910*
		okensko siva	45°; TSS; 90°	210	210	476908*
		prometno bela	45°; TSS; 90°	210	210	476907*
		signalno črna	45°; TSS; 90°	210	210	A 476906*
		sivo rjava	45°; TSS; 90°	210	210	476909*

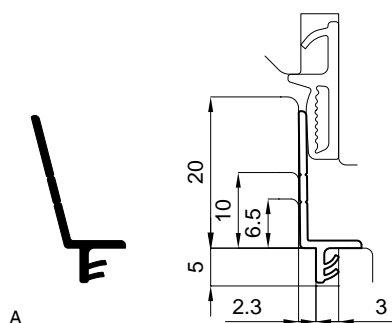

2.4.3 TC2021



L



N^o

TC2021						
TC2021	bež	45°; TSS; 90°	130	130		476916*
	grafitno siva RAL 7024	45°; TSS; 90°	130	130		478049*
	okensko siva	45°; TSS; 90°	130	130		476914*
	prometno bela	45°; TSS; 90°	130	130		476913*
	signalno črna	45°; TSS; 90°	130	130	A	476912*
	sivo rjava	45°; TSS; 90°	130	130		476915*

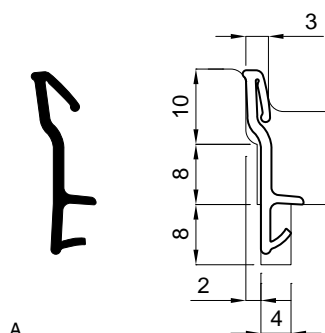

2.4.4 TC2033



L



N^o

TC2033	signalno črna	45°; TSS; 90°	100	100	A	478102*
--------	---------------	---------------	-----	-----	---	---------

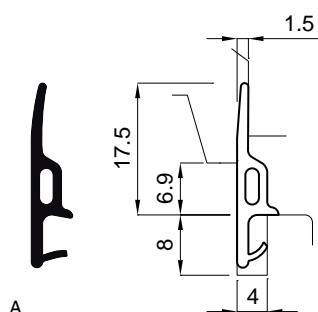

2.4.5 TC2034



L



N^o

TC2034	signalno črna	45°; TSS; 90°	150	150	A	478153*
--------	---------------	---------------	-----	-----	---	---------

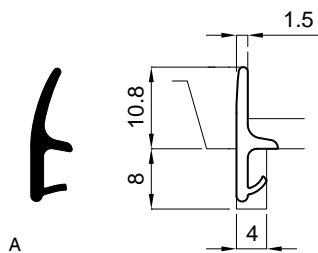

2.4.6 TC2035



L



N₀

TC2035

signalno črna

90°; TSS

200

200

A

478187

2.5 zaključki za sredino

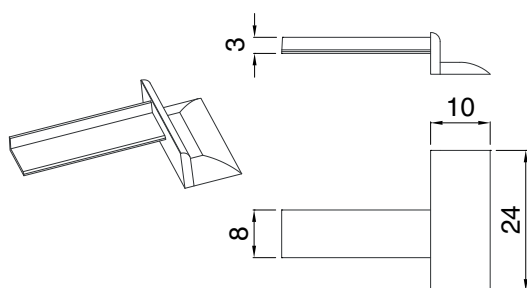
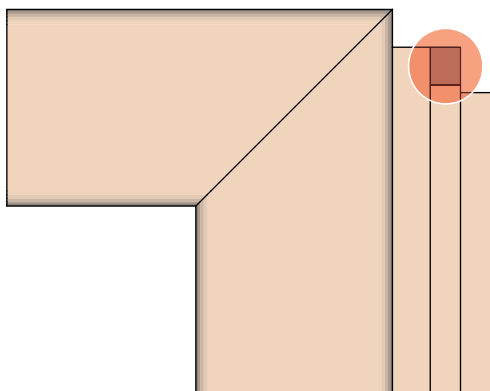

A

2.5.1 Zaključek univerzalen 10



N^o

bež	100		477002*
okensko siva	100		477001*
prometno bela	100	A	476999*
signalno črna	100		476998*
sivo rjava	100		477000*

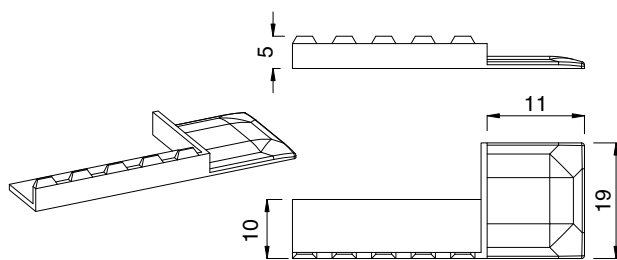

A

2.5.2 Zaključek univerzalen 11



N^o

bež	100		476997*
okensko siva	100		476996*
prometno bela	100	A	476994*
signalno črna	100		476993*
sivo rjava	10		476995*

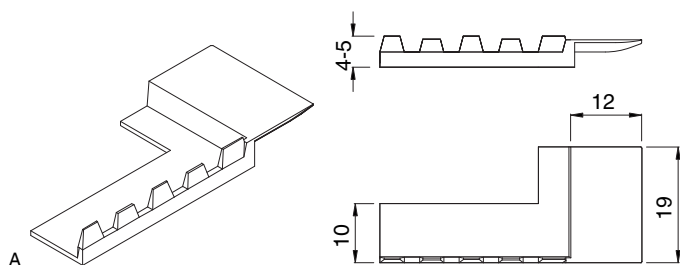

2.5.3 Zaključek univerzalen 12



№

bež	100		476987*
okensko siva	100		476986*
prometno bela	100	A	476984*
signalno črna	100		476983*
sivo rjava	100		476985*

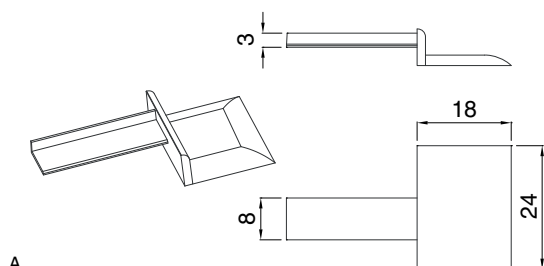

2.5.4 Zaključek univerzalen 18



№

bež	100		477007*
okensko siva	100		477006*
prometno bela	100	A	477004*
signalno črna	100		477003*
sivo rjava	100		477005*

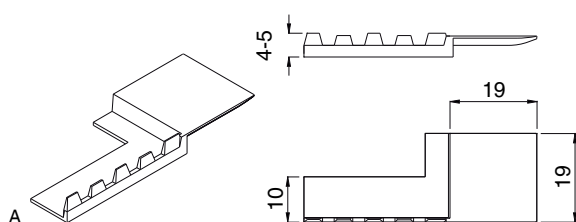

2.5.5 Zaključek univerzalen 19



№

bež	100		476992*
okensko siva	100		476991*
prometno bela	100	A	476989*
signalno črna	100		476988*
sivo rjava	100		476990*

2.6 zasteklitvena tesnila les

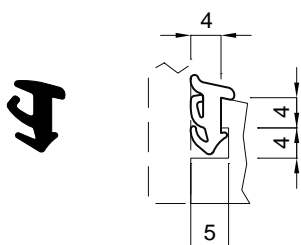
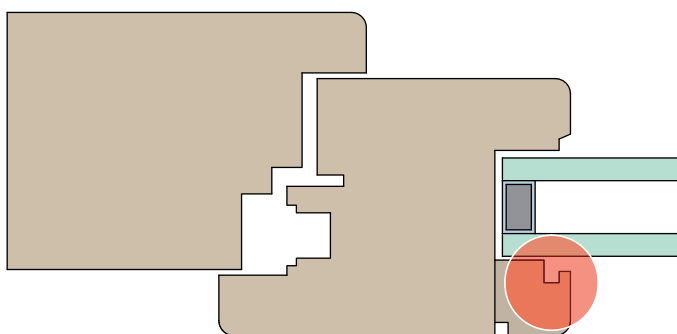

2.6.1 TC2036



L



N_o

TC2036

bež

45°; 90°; TSS

250

250

478199*

prometno bela

45°; 90°; TSS

250

250

478200*

signalno črna

45°; 90°; TSS

250

250

A

478197*

sivo rjava

45°; 90°; TSS

250

250

478198*

2.7 zasteklitvena tesnila aluminij

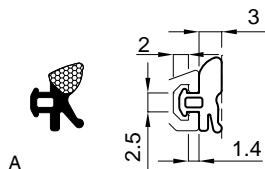
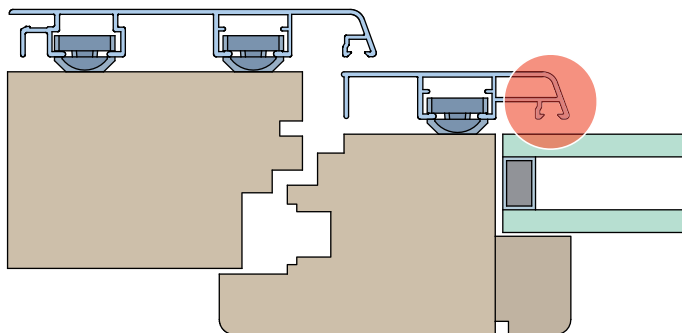

2.7.1 EE5007



EE5007

signalno črna

300

300

A

477861*

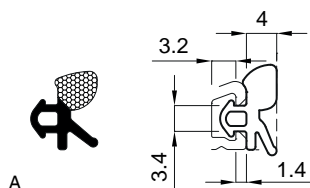

2.7.2 EE5008



EE5008

signalno črna

250

250

A

477862*

2.8 tesnila za prislon

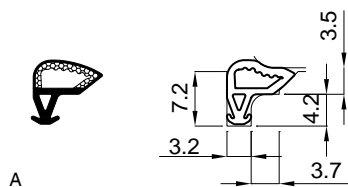
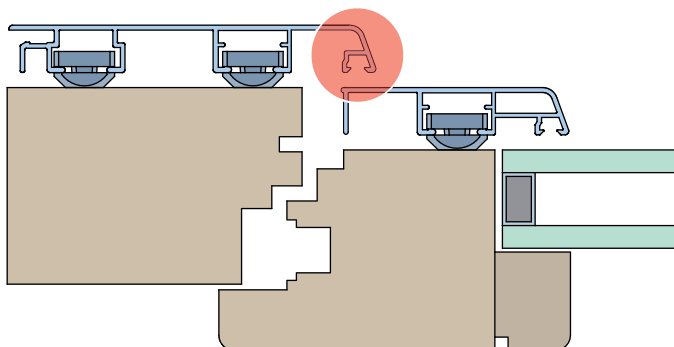

2.8.1	TE3016			L		N_o
	TE3016	okensko siva	90°; UNIV; TSS	300	300	477957*
		prometno bela	90°; UNIV; TSS	300	300	477956*
		signalno črna	90°; UNIV; TSS	300	300	477958*
		sivo rjava	90°; UNIV; TSS	300	300	A 477955*
		svetlo siva	90°; UNIV; TSS	300	300	477959*

3 vrata

3.1 tesnila za vhodna vrata ugodno

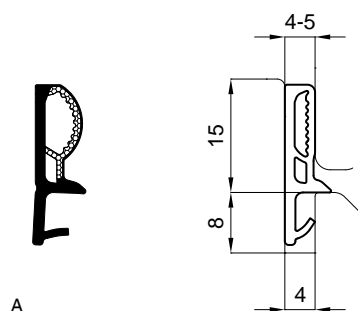
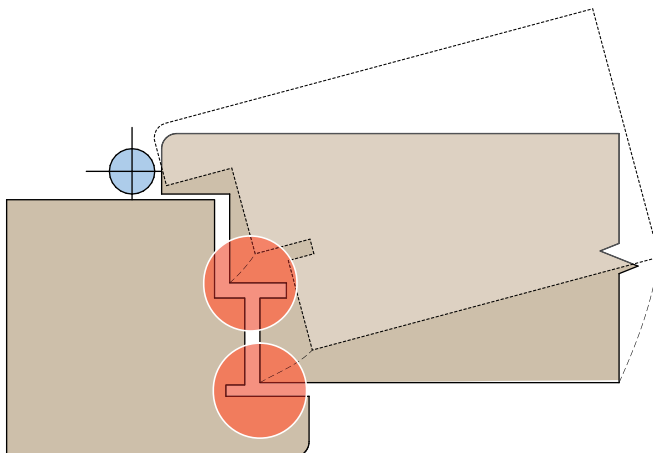

A

3.1.1 TE3005

			✂	L		N ^o
	TE3005	bež	90°; UNIV	170	170	476575*
		okensko siva	90°; UNIV	170	170	476572*
		prometno bela	90°; UNIV	170	170	476574*
		signalno črna	90°; UNIV	170	170	A 476571
		sivo rjava	90°; UNIV	170	170	476573*

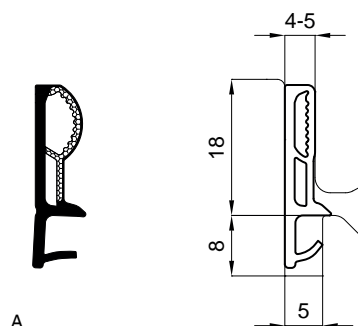

A

3.1.2 TE3006

				✂	L		N ^o
	TE3006	bež	90°; UNIV	170	170	476580*	
		okensko siva	90°; UNIV	170	170	476577*	
		prometno bela	90°; UNIV	170	170	476579*	
		signalno črna	90°; UNIV	170	150	A 476576	
		sivo rjava	90°; UNIV	170	170	476578*	

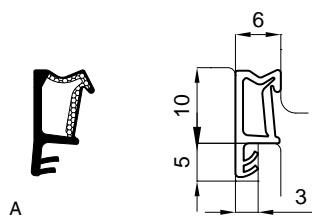

3.1.3 TE3008

				L		No	
	TE3008	bež	45°; TSS	230	230	A	476503*
		okensko siva	45°; TSS	230	230		476504*
		prometno bela	45°; TSS	230	230		476506*
		signalno črna	45°; TSS	230	230		476507
		sivo rjava	45°; TSS	230	230		476505*

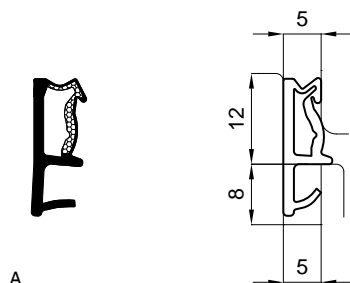

3.1.4 TE3009

				L		No	
	TE3009	bež	45°; TSS; UNIV	200	200	A	476508
		okensko siva	45°; TSS; UNIV	200	200		476509*
		prometno bela	45°; TSS; UNIV	200	200		476511
		signalno črna	45°; TSS; UNIV	200	200		476512
		sivo rjava	45°; TSS; UNIV	200	200		476510

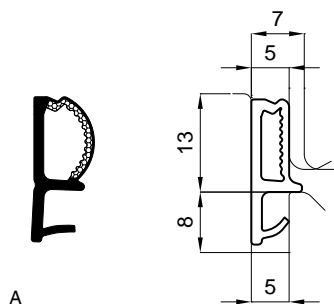

3.1.5 TE3010a

				L		No	
	TE3010a	bež	90°; UNIV; TSS	190	190		476895*
		okensko siva	90°; UNIV; TSS	190	190		476893*
		prometno bela	90°; UNIV; TSS	190	190		476892*
		signalno črna	90°; UNIV; TSS	190	190	A	476891*
		sivo rjava	90°; UNIV; TSS	190	190		476894*
		svetlo siva	90°; UNIV; TSS	190	190		478048*

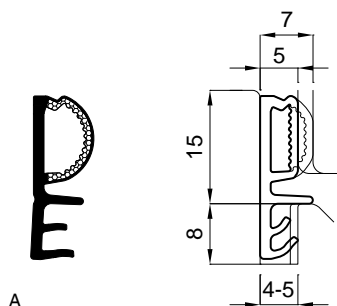

3.1.6 TE3017

			✂	L		№
	TE3017	bež	45°; TSS; 90°	130	130	478030*
		prometno bela	45°; TSS; 90°	130	130	478031*
		signalno črna	45°; TSS; 90°	130	130	A 478029*
		sivo rjava	45°; TSS; 90°	130	130	478033*
		svetlo siva	45°; TSS; 90°	130	130	478032*

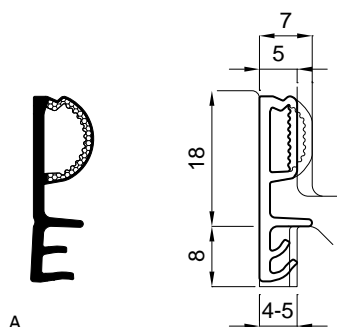

3.1.7 TE3018

			✂	L		№
	TE3018	prometno bela	45°; TSS; 90°	110	110	478037*
		signalno črna	45°; TSS; 90°	110	110	A 478035*
		sivo rjava	45°; TSS; 90°	110	110	478036*

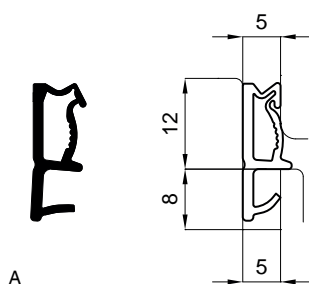

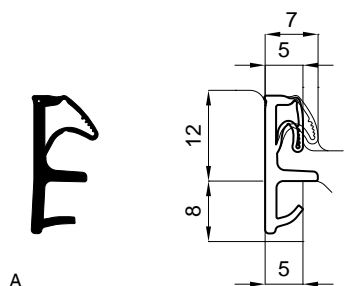

3.1.8 TC2002

			✂	L		№
	TC2002	bež	45°; TSS	200	200	A 476497*
		okensko siva	45°; TSS	200	200	476498*
		prometno bela	45°; TSS	200	200	476500*
		signalno črna	45°; TSS	200	200	476501
		sivo rjava	45°; TSS	200	200	476499*



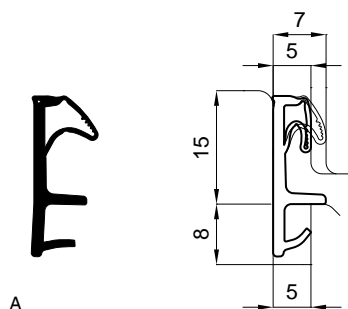

3.1.9 SC6003a

				L			N^o
	SC6003a	bež	45°; 90°	140	140	A	476725*
		okensko siva	45°; 90°	140	140		476727*
		prometno bela	45°; 90°	140	140		476728*
		signalno črna	45°; 90°	140	140		476729*
		sivo rjava	45°; 90°	140	140		476726*



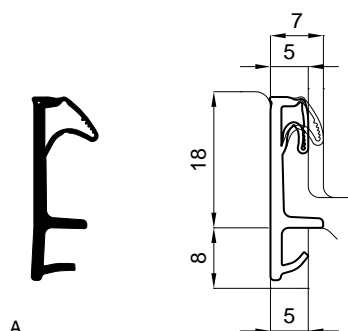

3.1.10 SC6004a

				L			N^o
	SC6004a	bež	45°; 90°	120	120	A	476731*
		okensko siva	45°; 90°	120	120		476733*
		prometno bela	45°; 90°	120	120		476734*
		signalno črna	45°; 90°	120	120		476735*
		sivo rjava	45°; 90°	120	120		476732*



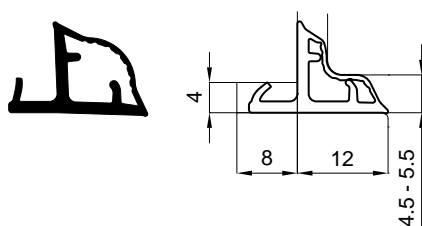

3.1.11 SC6005a

				L			N^o
	SC6005a	bež	45°; 90°	100	100	A	476737*
		okensko siva	45°; 90°	100	100		476739*
		prometno bela	45°; 90°	100	100		476740*
		signalno črna	45°; 90°	100	100		476741*
		sivo rjava	45°; 90°	100	100		476738*



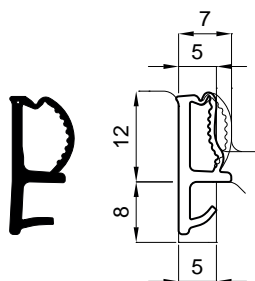

A

3.1.12 SC6006b				L			
	SC6006b	bež	90°	100	100	A	476743*
		okensko siva	90°	100	100		476745*
		prometno bela	90°	100	100		476746*
		signalno črna	90°	100	100		476747*
		sivo rjava	90°	100	100		476744*





A

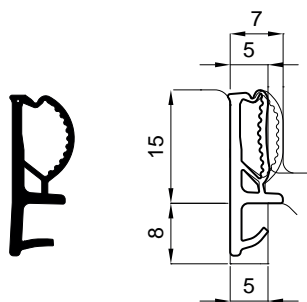

3.1.13 SC6007				L			
	SC6007	bež	45°; 90°	140	140	A	477274*
		okensko siva	45°; 90°	140	140		477276*
		prometno bela	45°; 90°	140	140		477277*
		signalno črna	45°; 90°	140	140		477278*
		sivo rjava	45°; 90°	140	140		477275*

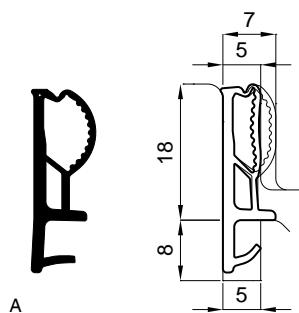

A

3.1.14 SC6008				L			
	SC6008	bež	45°; 90°	120	120	A	477280*
		okensko siva	45°; 90°	120	120		477282*
		prometno bela	45°; 90°	120	120		477283*
		signalno črna	45°; 90°	120	120		477284*
		sivo rjava	45°; 90°	120	120		477281*



3.1.15 SC6009			L			N^o
	SC6009	bež	45°; 90°	100	100	A 477286*
		okensko siva	45°; 90°	100	100	477288*
		prometno bela	45°; 90°	100	100	477289*
		signalno črna	45°; 90°	100	100	477290*
		sivo rjava	45°; 90°	100	100	477287*

3.2 notranje tesnilo ugodno

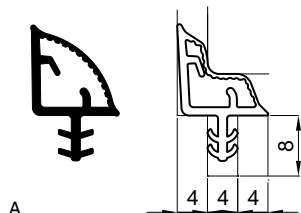
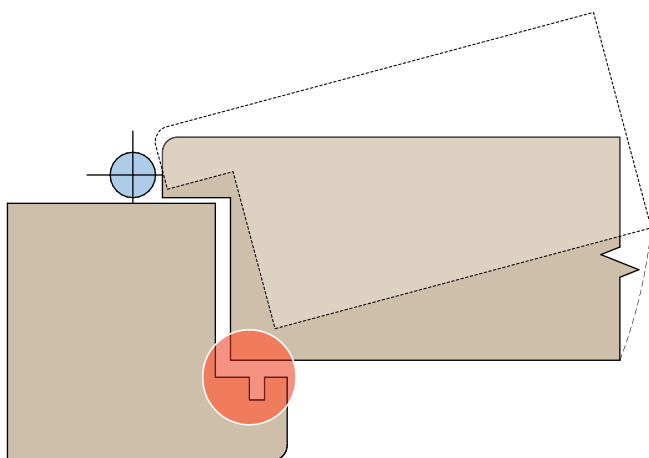

3.2.1 TC2022d

	TC2022d							
		bež	90°; 45°		120	120	A	476972*
		okensko siva	90°; 45°		120	120		476974*
		prometno bela	90°; 45°		120	120		476975*
		signalno črna	90°; 45°		120	120		476976*
		sivo rjava	90°; 45°		120	120		476973*

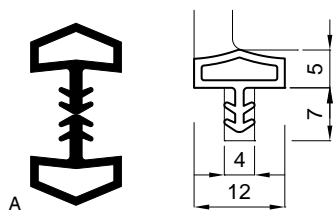

3.2.2 PC1001

	PC1001							
		bež	45°; 90°	v paru	(70x2)	140	140	
		prometno bela	45°; 90°	v paru	(70x2)	140	140	
		signalno rjava	45°; 90°	v paru	(70x2)	140	140	A
		signalno črna	45°; 90°	v paru	(70x2)	140	140	
		sivo rjava	45°; 90°	v paru	(70x2)	140	140	

3.3 tesnila za notranja vrata neugodno

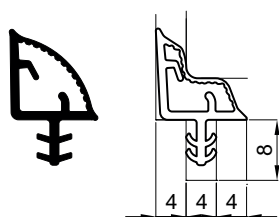
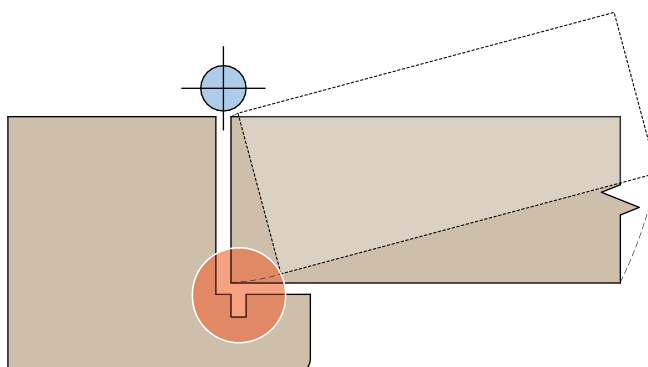

3.3.1 TC2022d



L



N₀

TC2022d

bež

90°; 45°

120

120

A

476972*

okensko siva

90°; 45°

120

120

476974*

prometno bela

90°; 45°

120

120

476975*

signalno črna

90°; 45°

120

120

476976*

sivo rjava

90°; 45°

120

120

476973*

3.4 talna tesnila

3.4.1 Hinweise zur Produktsicherheit und Produkthaftung für Bodentürdichtungen

6.1. informacija o proizvodu in določanje o skladnosti uporabe

naslednja talna tesnila ponuja podjetja Maco GmbH:

dimno- zvočno tesno, mini, samostojno nastavljivo in talna tesnila za steklena vrata

lastnosti proizvoda

tesnilni sistemi za uporabo spodaj vodoravno v vratnem krilu za pokritje razpoke med vratnim krilom in talno površino. Skozi vključitev mahanizna se tesnilo spusti in tako onemogoča pihanje skozi vrata, omili hrup in vdor prašine v prostor.

področje uporabe

vhodna vrata v različnih materialih (les; umetna masa; jeklo) notranjih vratih in steklenih vratih

6.2. važna navodila

posebna navodila

- i. talna tesnila se dobavljajo v fiksnih dolžinah, katera se lahko po priloženem navodilu na željeno mero skrajšajo. Ta mera zadostuje za minimalno skrajšanje do naslednje manjše fiksne dolžine. Navedena dolžina za skrajšanje se nikakor nesme preseči.
- ii. Maksimalen hod talnega tesnila je v priloženem navodilu naveden in se nesme nikakor preseči. Tu obstaja nevarnost za poškodovanje mehanizma in normalnega uporabljanja talnega tesnila.
- iii. Za pravilno uporabo in doseg maksimalnega željenega učinka je potrebno upoštevati navodila za reguliranje posameznega modela, katera so navedena v montažnih navodilih. Napačna vgradnja ali napačno reguliranje vplivajo na funkcijo talnega tesnila.
- iv. Poseben poudarek je potrebno pri izbiri talnega tesnila v primeru uporabe na njegovih lastnostih. Priporočljiva je vedno povratna informacija od specialista na tem področju.

6.3. Nepravilna uporaba

Vsak prejemnik dobavljenih proizvodov, t.p.vsi, kateri proizvod prejmenjo, uporabijo, preprodajajo itd, so brez izjeme zavezani, k predpisom in navodilom predloženega tehničnega lista in tam navedenih dokumentov striktno upoštevati.

Vsi prejemniki, zlasti osebe/poklicne skupine kateri so navedeni pod št. 4 tega tehničnega lista, morajo na podlagi svoje informacijske obveznosti dobavljenih proizvodov nasproti svojih strank, monterjev oz. uporabnikov proizvodov MACO ustrezno informirati. Poleg tega je še obvezno, pozornost nameniti dokumentu o vgradnji in uporabi raznih elementov v zvezi z skladiščenjem, uporabo, dostavo in ravnanjem proizvodov MACO. Posebno je potrebno tudi omeniti oškodovanja, katera lahko nastanejo pri napačni in nepravilni uporabi proizvodov MACO.

Posebno je potrebno tudi omeniti oškodovanja, katera lahko nastanejo pri napačni in nepravilni uporabi talnega tesnila. O napačni vgradnji se pogovarjamo če:

- a) priložena montažna-in navodila vgradnje od proizvoda niso bila upoštevana
- b) navodila skladiščenja in transporta niso bila upoštevana
- c) pri poskusu proizvoda uporabe za njega na nepravilnem mestu ali nepravilni vgradnji proizvoda
- d) pri neprevilnem krajšanju ali spremembi celotnih delov talnega tesnila, ter neupoštevanju vgradnih in montažnih načrtov v njihovem delovanju.

6.4. Informacijska- in šolska naloga

Uporaba predloženega dokumenta se naslanja samo za prejemnike proizvodov npr. brez izjeme vsi kateri ta proizvod dobijo, uporabljajo, preprodajajo itd. nihče ni izzet. Na primer navajamo tukaj naslednje specialne uporabnike.

6.4.1. Načrtovalec

zajema vsa podjetja/osebe, katera sodelujejo v planiranju gradnji zgradb in s tem povezanih vgradnji okenskih/vratnih/sistemov in Bodentürdichtungssystemen vključno z vgrajenimi materiali in proizvodi.

6.4.2. Grosisti

zajema vsa podjetja/osebe, katera repromaterijale od določenih proizvajalcev dobavljajo in jih brez sprememb oziroma predelava prodajo naprej

6.4.3. Proizvajalci okenskih/vratnih/sistemov

zajema vsa podjetja/osebe katera repromaterijale od določenih proizvajalcev prejemanjo in v zvezi s tem te proizvode uporabijo ali vgradijo naprej, na okenskih/vratnih/sistemih k katerim sodijo tudi sistemi talnih tesnil.

6.4.4. Grosisti/prodajalci/montažerji

Grosisti/prodajalci/ gradbenih proizvodov/ so vsa navedena podjetja/osebe katera okenske/vratne/sisteme dobavljajo pri proizvajalcih, in jih brez kakršnihkoli sprememb prodajo naprej ali vgradijo na objektu. Montažerji so vsa podjetja/osebe kateri okenske/vratne/sisteme kupijo od proizvajalca in jih brez kakršnihkoli sprememb vgradijo na objektu

6.4.5. Naročnik

zajema vsa podjetja/osebe katere naročijo okenske/vratne/sisteme pri proizvajalcu zaradi vgradnje le-teh na naročnikovem objektu.

6.4.6. Končna stranka/Uporabnik

zajema vse osebe katere okenske/vratne/sisteme uporabljajo. Takšne osebe imenujemo tudi uporabnik.

Z nemenom da informacije izpolnjujejo zahtevana navodila in razlage uporabe namenoma jamstvo MACO proizvodov v skladu z kodeksom o potrošniku odloka 206/2005 vsi prejemniki teh proizvodov na podlagi točke (5) predložene dokumentacije



(v tako imenovani označeni proizvodni dokumentaciji) ne glede na ta kateri odsek v celotni dokumentaciji zajema to področje.

- Načrtovalci so tretirani kot osebe katere informirajo naročnike oken/vrat na podlagi pridobitve aktualne verzije proizvodnih informacij MACO, katere se morajo tudi upoštevati (glej točko 5)
- Grosisti prodaje morajo priskrbeti aktualno verzijo informacije o proizvodih (glej točko 5) zlasti pri MACO tehničnih listih, montažnih navodilih, navodilih za uporabo in vzdrževanje in če ne drugače zahtevano tudi varnostna tehnična navodila, katera morajo biti dosegljiva proizvajalcem oken/vrat, katere se lahko tudi posredujejo montažerjem ali gradbenim podjetjem.
- Grosisti gradbenih proizvodov/montažerji so primorani, le to informacijo o proizvodu posredovati naprej (glej točko 5) zlasti pri dobaviteljnih okenskih/vratnih/sistemov kateri morajo navodila za vzdrževanje in uporabo predati na končnega naročnika.

6.5. Dosegljiva, dokumentacija katera se mora upoštevati

naslednja dokumentacija zajema zavezujoči predpisi v primeru uporabe proizvodov TESNILA:

- I. Katalog proizvodov
- II. montažni in uporabni načrt zajet v pokiranjju proizvoda
- III. navodilo za uporabo/shranjevanje/varnost (če je potrebno)
- IV. Varnostni tehnični list (če je predviden)
- V. Tehnični listi proizvodov

aktualna verzija zgoraj navedenih dokumentov se lajko dostavi v papirnati obliki ali se pa sname iz internetne strani: <http://www.maco.eu/it-it/,Bereich Download>

6.6. navodila za skladiščenje

- i. embalažo ne preobtežiti
- ii. proizvode skladiščiti v horizontalni legi
- iii. proizvode zaščititi pred odprtim ognjem ali vročino med

skladiščenjem

- iv. proizvode skladiščiti v originalni embalaži, tudi po odprtju celotnega paketa
- v. paziti na temperaturo skladišča (če je predpisano)
- vi. talna tesnila in embalažo ne smemo kriviti

6.7. omejitev odgovornosti

Vse informacije in navodila v tem dokumentu so bili ustvarjeni z pomočjo tehnologije glede na izkušnje in znanja pridobljene z upoštevanjem veljavnih standardov in predpisov.

Za varnost in uporabo so vsa navodila v dokumentaciji pri uporabi proizvodov TESNILA (GLEJ TOČKO 2 IN 5) ki zagotavljajo varnost in primernost uporabe MACO prejemnikom proizvodov TESNILA. Neupoštevanje navodil ali zloraba le teh velja za riziko le tega oseba z določeno odgovornostjo po točki 3. Če se uporablja oziroma vgrajuje na podlagi odstopanja po specifikaciji proizvajalca kateri je uredil sistem, lahko avtomatično takšno preverjanje skladnosti preveri za to usposobljena oseba kateri pristojnost določi proizvajalec. MACO GmbH tudi v tem primeru izvzet za odgovarjanje odgovornosti:



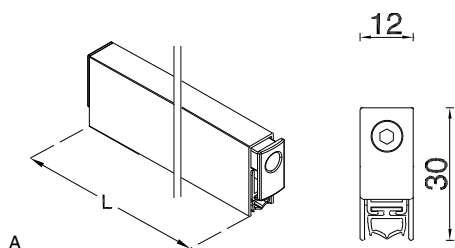

- a) če je pomankljivost na osnovi zakona ali administracijskega predpisa, katerim ta proizvod ustreza
- b) če je na podlagi veljavnega strokovnega načela v tem trenutku uvajanje proizvoda na tržišče skozi katerega lastnosti se je možno pritoževati, se le to kot navedena napaka ne priznava.
- c) če pritoževalec naredi samo en element ali polizdelek in se napaka pokaže že v fazi konstrukcije proizvoda, v kaj ali katero je bil element ali polizdelek integriran, ali če se napaka pokaže na podlagi pomanjkljivosti od/ali uporabnika teh proizvodov TESNIL (glej točko 3) in ni bil sprejet določeni postopek v nastanku te napake.

MACO GMBH ne prevzema nobene odgovornosti za procesne ali dosežne napake ali škode če so le te povzročene na podlagi neupoštevanja točke 2., 3., 5. und 6. (v posamičnih delih 2.i, ii, iii, iv, 3.a-d, 5. I,II,III,IV,V, 6. i, ii, iii, iv, v, vi.).



3.4.2 Talna tesnila samonastavljiva



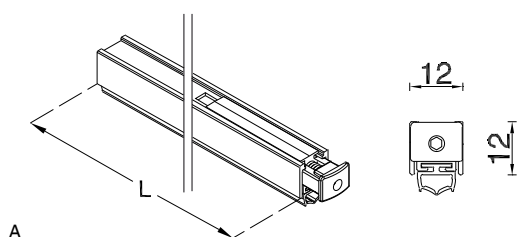

eno pakiranje

L					No
334	12	30	3 - 14	1	D13530
459	12	30	3 - 14	1	D13531
584	12	30	3 - 14	1	D13532
709	12	30	3 - 14	1	D13533
834	12	30	3 - 14	1	D10433
959	12	30	3 - 14	1	D13534
1.084	12	30	3 - 14	1	D13535
1.209	12	30	3 - 14	1	D13536
industrialno pakiranje					
334	12	30	3 - 14	5	D13537
459	12	30	3 - 14	5	D13538
584	12	30	3 - 14	5	D13539
709	12	30	3 - 14	5	D13540
834	12	30	3 - 14	5	D13541
959	12	30	3 - 14	5	D13542
1.084	12	30	3 - 14	5	D13543
1.209	12	30	3 - 14	5	D13544







3.4.3 Talno tesnilo mini

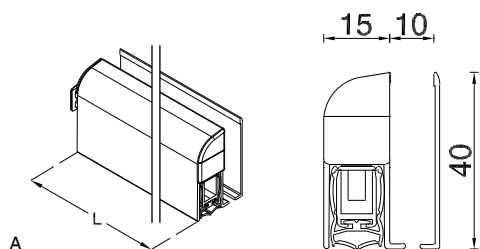



eno pakiranje

L					No
334	12	12	3 - 8	1	D13545
459	12	12	3 - 8	1	D13546
584	12	12	3 - 8	1	D13547
709	12	12	3 - 8	1	D13548
834	12	12	3 - 8	1	D10424
959	12	12	3 - 8	1	D13549
1.084	12	12	3 - 8	1	D13550
1.209	12	12	3 - 8	1	D13551
industrialno pakiranje					
334	12	12	3 - 8	10	D13552
459	12	12	3 - 8	10	D13553
584	12	12	3 - 8	10	D13554
709	12	12	3 - 8	10	D13555
834	12	12	3 - 8	10	D13556
959	12	12	3 - 8	10	D13557
1.084	12	12	3 - 8	10	D13558
1.209	12	12	3 - 8	10	D13559

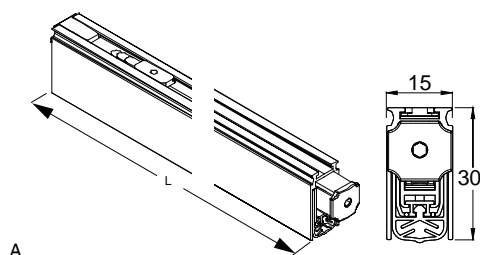

3.4.4 Talno tesnilo steklo	L					No
eno pakiranje	350	15	40	3 - 14	1	454330*
	459	15	40	3 - 14	1	A 454011*
	584	15	40	3 - 14	1	454012*
	709	15	40	3 - 14	1	454013*
	834	15	40	3 - 14	1	454014*
	959	15	40	3 - 14	1	454015*
	1.084	15	40	3 - 14	1	454016*
	1.209	15	40	3 - 14	1	454017*
	1.334	15	40	3 - 14	1	454018*



3.4.5 Talno tesnilo 54dB	L					No
eno pakiranje	459	15	30	3 - 15	1	460713 ^{1*}
	584	15	30	3 - 15	1	460714 ^{1*}
	709	15	30	3 - 15	1	460715 ^{1*}
	834	15	30	3 - 15	1	460716 ¹
	959	15	30	3 - 15	1	460717 ¹
	1.084	15	30	3 - 15	1	460718 ¹
	1.209	15	30	3 - 15	1	460719 ^{1*}
industrijsko pakiranje	459	15	30	3 - 15	5	A 460706 ¹
	584	15	30	3 - 15	5	460707 ¹
	709	15	30	3 - 15	5	460708 ¹
	834	15	30	3 - 15	5	460709 ¹
	959	15	30	3 - 15	5	460710 ¹
	1.084	15	30	3 - 15	5	460711 ¹
	1.209	15	30	3 - 15	5	460712 ¹

¹ za pritrjevanje z pritrditvenimi kotniki se mora dodatno naročiti artikel 460720 (pritrjevalni kotniki in vijaki)

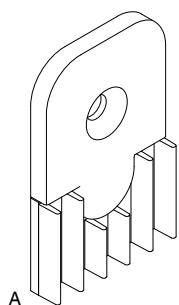

A

3.4.6 Phon Stop za talno tesnilo



No

Phon Stop za talno tesnilo Maco Rauch- und Schallschutz 15x30mm - 54dB

50

A

460939

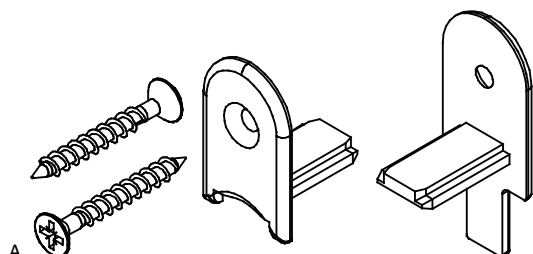

A

3.4.7 pritrjevalni kotnik za talno tesnilo



No

Pritrjevalni kotnik in vijak za talno tesnilo dimno - in hrupnotesno 15x30 mm -54 dB

1

A

460720

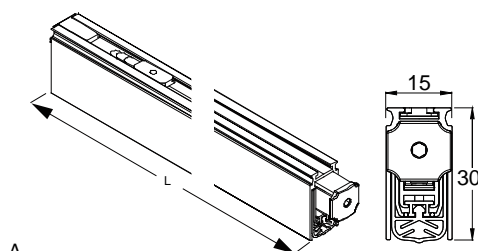

A

3.4.8 talno tesnilo 54dB z že vgrajenimi vijaki

L



No

industrijsko pakiranje

459

15

30

20

5

461459*

584

15

30

20

5

461460*

709

15

30

20

5

A

461461*

834

15

30

20

5

461462*

959

15

30

20

5

461463*

1.084

15

30

20

5

461464*

1.209

15

30

20

5

461465*

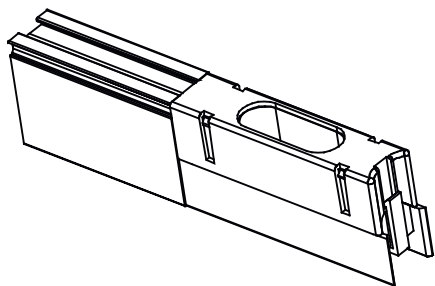

A

3.4.9 dodatek za zapah talnega tesnila



N_o

Dodatek za zapah talno tesnilo dimno - in hrupnotesno 15x30mm - 54dB mod. DSD1530

1

A

460940

4 HS

4.1 srednja partija

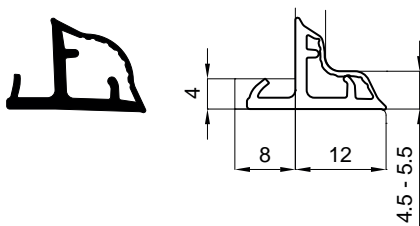
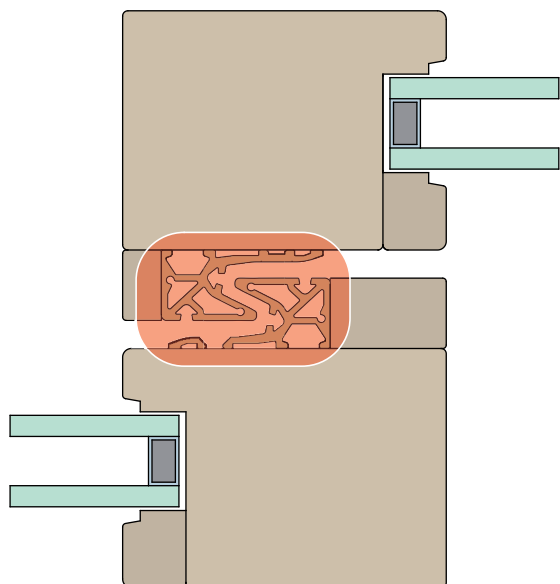

A

4.1.1	SC6006b		✂	L			№
	SC6006b	bež	90°	100	100	A	476743*
		okensko siva	90°	100	100		476745*
		prometno bela	90°	100	100		476746*
		signalno črna	90°	100	100		476747*
		sivo rjava	90°	100	100		476744*

4.2 vodilna letev

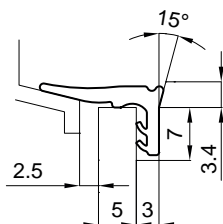
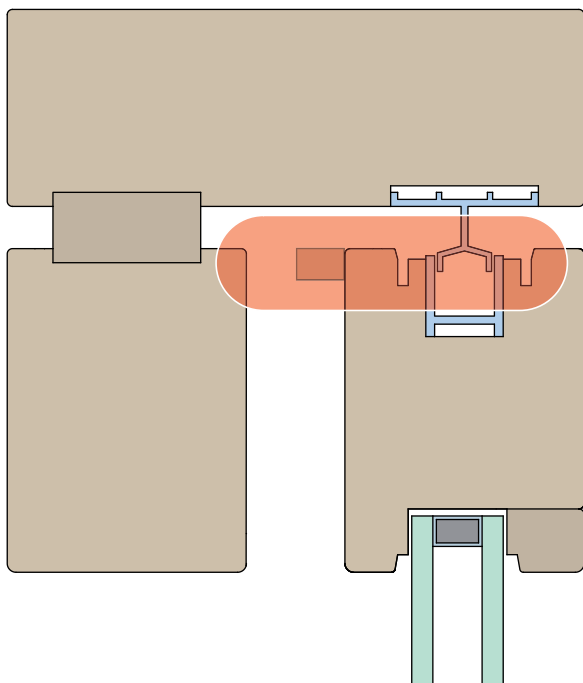

A

4.2.1 TC2023				L		No		
TC2023	bež	90°; 45°	v paru	(90x2)	180	180	A	477050*
	okensko siva	90°; 45°	v paru	(90x2)	180	180		477052*
	prometno bela	90°; 45°	v paru	(7,5x2)	15	15		478137*
	signalno črna	90°; 45°	v paru	(90x2)	180	180		477053*
				(7,5x2)	15	15		478136*
	sivo rjava	90°; 45°	v paru	(90x2)	180	180		477054*
				6 kos po 30 m (15x2)	180	180		478134*
				(7,5x2)	15	15		478135*
				(90x2)	180	180		477051*
				6 kos po 30 m (15x2)	180	180		478133*

4.3 na strani gonilke spodaj

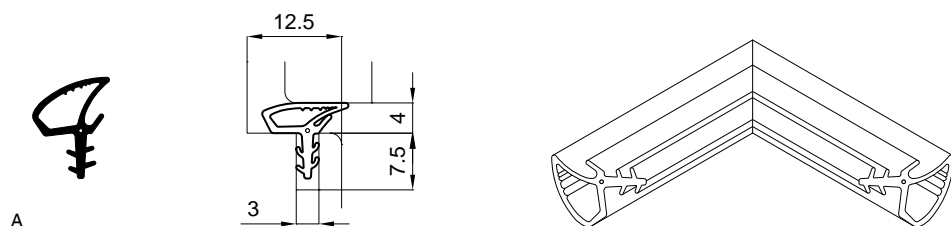
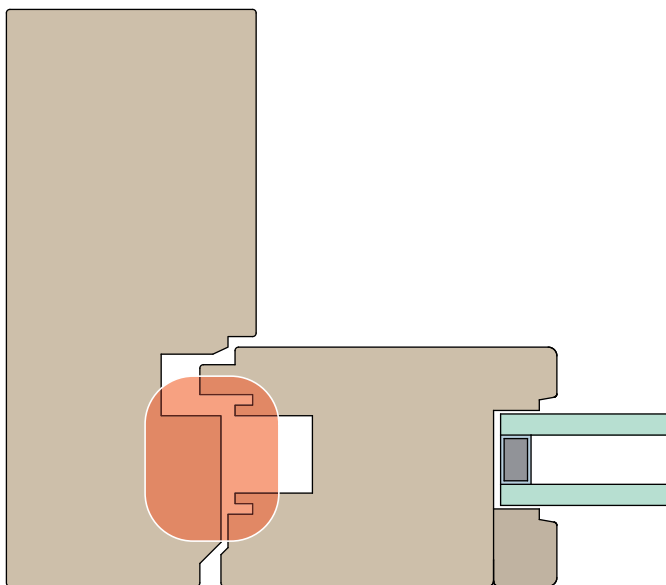

A

4.3.1 SC6001			B	H		N^o	
silikon	SC6001a	antracitno siva	2,5	2,5	20	A	477105
		signalno črna	2,5	2,5	20		476545
		svetlo siva	2,5	2,5	20		476550
	SC6001b	antracitno siva	3,5	3,5	15		477104
		signalno črna	3,5	3,5	15		476551
		svetlo siva	3,5	3,5	15		476555
	SC6001c	antracitno siva	1,5	2,5	20		477103
		signalno črna	1,5	2,5	20		476556
		svetlo siva	1,5	2,5	20		476560

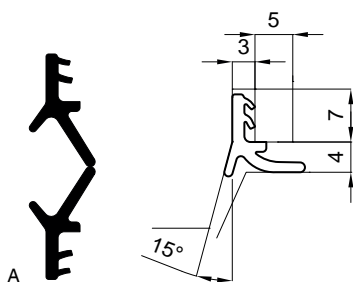

4.3.2 TC2024						L		A		№		
TC2024	bež	90°; 45°	v paru	(90x2)	180	180					477056*	
	okensko siva	90°; 45°	v paru	(90x2)	180	180					477058*	
	prometno bela	90°; 45°	v paru	(15x2)	30	30					478143*	
				(90x2)	180	180						477059*
	signalno črna	90°; 45°	v paru	6 kos po 30 m (15x2)	180	180					478140*	
				(15x2)	30	30						478142*
				(90x2)	180	180						477060*
	sivo rjava	90°; 45°	v paru	6 kos po 30 m (15x2)	180	180					478139*	
				(15x2)	30	30						478141*
				(90x2)	180	180						477057*
				6 kos po 30 m (15x2)	180	180					478138*	

5 Index

No	Skupina	 € (100 = 100 kom)	Stran
4			
454011	IT-L-2-1	1	40
454012	IT-L-2-1	1	40
454013	IT-L-2-1	1	40
454014	IT-L-2-1	1	40
454015	IT-L-2-1	1	40
454016	IT-L-2-1	1	40
454017	IT-L-2-1	1	40
454018	IT-L-2-1	1	40
454330	IT-L-2-1	1	40
460706	IT-L-2-1	5	40
460707	IT-L-2-1	5	40
460708	IT-L-2-1	5	40
460709	IT-L-2-1	5	40
460710	IT-L-2-1	5	40
460711	IT-L-2-1	5	40
460712	IT-L-2-1	5	40
460713	IT-L-2-1	1	40
460714	IT-L-2-1	1	40
460715	IT-L-2-1	1	40
460716	IT-L-2-1	1	40
460717	IT-L-2-1	1	40
460718	IT-L-2-1	1	40
460719	IT-L-2-1	1	40
460720	IT-L-2-4	1	41
460939	IT-L-2-4	50	41
460940	IT-L-2-4	1	42
461459	IT-L-2-1	5	41
461460	IT-L-2-1	5	41
461461	IT-L-2-1	5	41
461462	IT-L-2-1	5	41
461463	IT-L-2-1	5	41
461464	IT-L-2-1	5	41
461465	IT-L-2-1	5	41
476366	IT-L-1-1	170	8
476367	IT-L-1-1	170	8
476368	IT-L-1-1	170	8
476369	IT-L-1-1	170	8
476370	IT-L-1-1	170	8
476371	IT-L-1-1	170	8
476372	IT-L-1-1	170	8
476373	IT-L-1-1	170	8
476374	IT-L-1-1	170	8
476375	IT-L-1-1	170	8
476376	IT-L-1-1	200	15
476377	IT-L-1-1	200	15
476378	IT-L-1-1	200	15
476379	IT-L-1-1	200	15
476380	IT-L-1-1	200	15
476482	IT-L-1-1	120	13
476483	IT-L-1-1	120	13
476484	IT-L-1-1	120	13
476485	IT-L-1-1	120	13
476486	IT-L-1-1	120	13
476487	IT-L-1-1	370	16
476488	IT-L-1-1	370	16
476489	IT-L-1-1	370	16
476490	IT-L-1-1	370	16
476491	IT-L-1-1	370	16
476492	IT-L-1-1	230	17
476493	IT-L-1-1	230	17
476494	IT-L-1-1	230	17
476495	IT-L-1-1	230	17
476496	IT-L-1-1	230	17
476497	IT-L-1-1	200	10,31
476498	IT-L-1-1	200	10,31
476499	IT-L-1-1	200	10,31
476500	IT-L-1-1	200	10,31
476501	IT-L-1-1	200	10,31

No	Skupina	 € (100 = 100 kom)	Stran
476503	IT-L-1-1	230	17,30
476504	IT-L-1-1	230	17,30
476505	IT-L-1-1	230	17,30
476506	IT-L-1-1	230	17,30
476507	IT-L-1-1	230	17,30
476508	IT-L-1-1	200	9,30
476509	IT-L-1-1	200	9,30
476510	IT-L-1-1	200	9,30
476511	IT-L-1-1	200	9,30
476512	IT-L-1-1	200	9,30
476545	IT-L-1-1-5	20	45
476550	IT-L-1-1-5	20	45
476551	IT-L-1-1-5	15	45
476555	IT-L-1-1-5	15	45
476556	IT-L-1-1-5	20	45
476560	IT-L-1-1-5	20	45
476566	IT-L-1-1	210	9,15
476567	IT-L-1-1	210	9,15
476568	IT-L-1-1	210	9,15
476569	IT-L-1-1	210	9,15
476570	IT-L-1-1	210	9,15
476571	IT-L-1-1	170	16,29
476572	IT-L-1-1	170	16,29
476573	IT-L-1-1	170	16,29
476574	IT-L-1-1	170	16,29
476575	IT-L-1-1	170	16,29
476576	IT-L-1-1	150	16,29
476577	IT-L-1-1	170	16,29
476578	IT-L-1-1	170	16,29
476579	IT-L-1-1	170	16,29
476580	IT-L-1-1	170	16,29
476581	IT-L-1-1	370	18
476582	IT-L-1-1	370	18
476583	IT-L-1-1	370	18
476584	IT-L-1-1	370	18
476585	IT-L-1-1	370	18
476586	IT-L-1-1	370	18
476587	IT-L-1-1	370	18
476588	IT-L-1-1	370	18
476589	IT-L-1-1	370	18
476590	IT-L-1-1	370	18
476634	IT-L-1-1	200	10,18
476635	IT-L-1-1	200	10,18
476636	IT-L-1-1	200	10,18
476637	IT-L-1-1	200	10,18
476638	IT-L-1-1	200	10,18
476690	IT-L-1-1	150	11
476691	IT-L-1-1	150	11
476692	IT-L-1-1	150	11
476693	IT-L-1-1	150	11
476694	IT-L-1-1	150	11
476695	IT-L-1-1	150	11,19
476696	IT-L-1-1	150	11,19
476697	IT-L-1-1	150	11,19
476698	IT-L-1-1	150	11,19
476699	IT-L-1-1	150	11,19
476725	IT-L-1-1	140	32
476726	IT-L-1-1	140	32
476727	IT-L-1-1	140	32
476728	IT-L-1-1	140	32
476729	IT-L-1-1	140	32
476731	IT-L-1-1	120	32
476732	IT-L-1-1	120	32
476733	IT-L-1-1	120	32
476734	IT-L-1-1	120	32
476735	IT-L-1-1	120	32
476737	IT-L-1-1	100	32
476738	IT-L-1-1	100	32
476739	IT-L-1-1	100	32
476740	IT-L-1-1	100	32



No	Skupina	 € (/100 = 100 kom)	Stran
476741	IT-L-1-1	100	32
476743	IT-L-1-1	100	33,43
476744	IT-L-1-1	100	33,43
476745	IT-L-1-1	100	33,43
476746	IT-L-1-1	100	33,43
476747	IT-L-1-1	100	33,43
476879	IT-L-1-1	220	20
476880	IT-L-1-1	220	20
476881	IT-L-1-1	220	20
476882	IT-L-1-1	220	20
476883	IT-L-1-1	220	20
476885	IT-L-1-1	200	12
476886	IT-L-1-1	200	12
476887	IT-L-1-1	200	12
476888	IT-L-1-1	200	12
476889	IT-L-1-1	200	12
476891	IT-L-1-1	190	30
476892	IT-L-1-1	190	30
476893	IT-L-1-1	190	30
476894	IT-L-1-1	190	30
476895	IT-L-1-1	190	30
476900	IT-L-1-1	180	21
476901	IT-L-1-1	180	21
476902	IT-L-1-1	180	21
476903	IT-L-1-1	180	21
476904	IT-L-1-1	180	21
476906	IT-L-1-1	210	21
476907	IT-L-1-1	210	21
476908	IT-L-1-1	210	21
476909	IT-L-1-1	210	21
476910	IT-L-1-1	210	21
476912	IT-L-1-1	130	22
476913	IT-L-1-1	130	22
476914	IT-L-1-1	130	22
476915	IT-L-1-1	130	22
476916	IT-L-1-1	130	22
476972	IT-L-1-2	120	35,36
476973	IT-L-1-2	120	35,36
476974	IT-L-1-2	120	35,36
476975	IT-L-1-2	120	35,36
476976	IT-L-1-2	120	35,36
476983	IT-L-1-1-6	100	25
476984	IT-L-1-1-6	100	25
476985	IT-L-1-1-6	100	25
476986	IT-L-1-1-6	100	25
476987	IT-L-1-1-6	100	25
476988	IT-L-1-1-6	100	25
476989	IT-L-1-1-6	100	25
476990	IT-L-1-1-6	100	25
476991	IT-L-1-1-6	100	25
476992	IT-L-1-1-6	100	25
476993	IT-L-1-1-6	100	24
476994	IT-L-1-1-6	100	24
476995	IT-L-1-1-6	10	24
476996	IT-L-1-1-6	100	24
476997	IT-L-1-1-6	100	24
476998	IT-L-1-1-6	100	24
476999	IT-L-1-1-6	100	24
477000	IT-L-1-1-6	100	24
477001	IT-L-1-1-6	100	24
477002	IT-L-1-1-6	100	24
477003	IT-L-1-1-6	100	25
477004	IT-L-1-1-6	100	25
477005	IT-L-1-1-6	100	25
477006	IT-L-1-1-6	100	25
477007	IT-L-1-1-6	100	25
477050	IT-L-1-1	180	44
477051	IT-L-1-1	180	44
477052	IT-L-1-1	180	44
477053	IT-L-1-1	180	44
477054	IT-L-1-1	180	44
477056	IT-L-1-1	180	46
477057	IT-L-1-1	180	46
477058	IT-L-1-1	180	46

No	Skupina	 € (/100 = 100 kom)	Stran
477059	IT-L-1-1	180	46
477060	IT-L-1-1	180	46
477103	IT-L-1-1-5	20	45
477104	IT-L-1-1-5	15	45
477105	IT-L-1-1-5	20	45
477227	IT-L-1-1	180	11
477274	IT-L-1-1	140	33
477275	IT-L-1-1	140	33
477276	IT-L-1-1	140	33
477277	IT-L-1-1	140	33
477278	IT-L-1-1	140	33
477280	IT-L-1-1	120	33
477281	IT-L-1-1	120	33
477282	IT-L-1-1	120	33
477283	IT-L-1-1	120	33
477284	IT-L-1-1	120	33
477286	IT-L-1-1	100	34
477287	IT-L-1-1	100	34
477288	IT-L-1-1	100	34
477289	IT-L-1-1	100	34
477290	IT-L-1-1	100	34
477390	IT-L-1-2	140	35
477391	IT-L-1-2	140	35
477392	IT-L-1-2	140	35
477393	IT-L-1-2	140	35
477394	IT-L-1-2	140	35
477396	IT-L-1-1	180	9
477397	IT-L-1-1	180	9
477398	IT-L-1-1	180	9
477399	IT-L-1-1	180	9
477400	IT-L-1-1	180	9
477402	IT-L-1-1	190	17
477403	IT-L-1-1	190	17
477404	IT-L-1-1	190	17
477405	IT-L-1-1	190	17
477406	IT-L-1-1	190	17
477408	IT-L-1-1	180	19
477409	IT-L-1-1	180	19
477410	IT-L-1-1	180	19
477411	IT-L-1-1	180	19
477412	IT-L-1-1	180	19
477414	IT-L-1-1	200	19
477415	IT-L-1-1	200	19
477861	IT-L-1-1	300	27
477862	IT-L-1-1	250	27
477866	IT-L-1-1	140	20
477867	IT-L-1-1	140	20
477868	IT-L-1-1	140	20
477869	IT-L-1-1	140	20
477870	IT-L-1-1	140	20
477885	IT-L-1-1	120	13
477886	IT-L-1-1	120	13
477887	IT-L-1-1	120	13
477889	IT-L-1-1	170	10
477890	IT-L-1-1	170	10
477891	IT-L-1-1	170	10
477955	IT-L-1-1	300	28
477956	IT-L-1-1	300	28
477957	IT-L-1-1	300	28
477958	IT-L-1-1	300	28
477959	IT-L-1-1	300	28
477962	IT-L-1-1	160	14
477964	IT-L-1-1	160	14
477990	IT-L-1-1	160	14
477991	IT-L-1-1	160	14
477992	IT-L-1-1	160	14
478029	IT-L-1-1	130	31
478030	IT-L-1-1	130	31
478031	IT-L-1-1	130	31
478032	IT-L-1-1	130	31
478033	IT-L-1-1	130	31
478035	IT-L-1-1	110	31
478036	IT-L-1-1	110	31
478037	IT-L-1-1	110	31



No	Skupina	 € (100 = 100 kom)	Stran
478047	IT-L-1-1	200	10,18
478048	IT-L-1-1	190	30
478049	IT-L-1-1	130	22
478102		100	22
478133		180	44
478134		180	44
478135		15	44
478136		15	44
478137		15	44
478138		180	46
478139		180	46
478140		180	46
478141		30	46
478142		30	46
478143		30	46
478153		150	22
478187		200	23
478197		250	26
478198		250	26
478199		250	26
478200		250	26

D

D10424	IT-L-2-2	1	39
D10433	IT-L-2-3	1	39
D13530	IT-L-2-3	1	39
D13531	IT-L-2-3	1	39
D13532	IT-L-2-3	1	39
D13533	IT-L-2-3	1	39
D13534	IT-L-2-3	1	39
D13535	IT-L-2-3	1	39
D13536	IT-L-2-3	1	39
D13537	IT-L-2-3	5	39
D13538	IT-L-2-3	5	39
D13539	IT-L-2-3	5	39
D13540	IT-L-2-3	5	39
D13541	IT-L-2-3	5	39
D13542	IT-L-2-3	5	39
D13543	IT-L-2-3	5	39
D13544	IT-L-2-3	5	39
D13545	IT-L-2-2	1	39
D13546	IT-L-2-2	1	39
D13547	IT-L-2-2	1	39
D13548	IT-L-2-2	1	39
D13549	IT-L-2-2	1	39
D13550	IT-L-2-2	1	39
D13551	IT-L-2-2	1	39
D13552	IT-L-2-2	10	39
D13553	IT-L-2-2	10	39
D13554	IT-L-2-2	10	39
D13555	IT-L-2-2	10	39
D13556	IT-L-2-2	10	39
D13557	IT-L-2-2	10	39
D13558	IT-L-2-2	10	39
D13559	IT-L-2-2	10	39

**MAYER & CO
BESCHLÄGE GMBH**
Alpenstraße 173
A-5020 Salzburg

Tel.: +43 662 6196-0
E-Mail: maco@maco.eu
www.maco.eu

Zadovoljni?

Mi bomo veseli vašega odgovora na
feedback@maco.eu

Št. za naročilo 757510 – Datum: maj 2018
Vse pravice pridržane. Pridržana pravica do sprememb.

Ta natisnjeni dokument bo kontinuirano posodobljen.
Aktualno verzijo najdete pod:
<http://www.maco.eu/sites/assets/MacoDocs/757510.pdf>
ali skenirajte QR-Codo.

